



GTB6-P4211S83

G6

PHOTOELECTRIC SENSORS

SICK
Sensor Intelligence.



Illustration may differ



Ordering information

Type	part no.
GTB6-P4211S83	1096868

Other models and accessories → www.sick.com/G6

Detailed technical data

Features

Functional principle	Photoelectric proximity sensor	
Functional principle detail	Background suppression	
Sensing range max.	5 mm ... 250 mm ¹⁾	
Sensing range	35 mm ... 140 mm	
Emitted beam	Light source	PinPoint LED ²⁾
	Type of light	Visible red light
	Light spot size (distance)	Ø 6 mm (100 mm)
Key LED figures	Wave length	650 nm
	Adjustment	Mechanical spindle, 5 turns
Special features	Preset 80 mm on black (potentiometer fixed)	

¹⁾ Object with 90% remission (based on standard white, DIN 5033).

²⁾ Average service life: 100,000 h at T_J = +25 °C.

Safety-related parameters

MTTF_D	1,905 years
DC_{avg}	0 %

Electronics

Supply voltage U_b	10 V DC ... 30 V DC ¹⁾
Ripple	$\pm 10\%$ ²⁾
Current consumption	30 mA ³⁾
Protection class	III
Digital output	
Type	PNP
Switching mode	Light/dark switching
Switching mode selector	Selectable via light/dark selector
Signal voltage PNP HIGH/LOW	$V_S - (\leq 3\text{ V}) / \text{approx. } 0\text{ V}$
Output current I_{max}	$\leq 100\text{ mA}$ ⁴⁾
Response time	$< 625\ \mu\text{s}$ ⁵⁾
Switching frequency	1,000 Hz ⁶⁾
Circuit protection	A ⁷⁾ B ⁸⁾ D ⁹⁾

¹⁾ Limit values when operated in short-circuit protected network: max. 8 A.

²⁾ May not fall below or exceed U_V tolerances.

³⁾ Without load.

⁴⁾ At $U_V > 24\text{ V}$, $I_A \text{ max.} = 50\text{ mA}$.

⁵⁾ Signal transit time with resistive load.

⁶⁾ With light/dark ratio 1:1.

⁷⁾ A = V_S connections reverse-polarity protected.

⁸⁾ B = inputs and output reverse-polarity protected.

⁹⁾ D = outputs overcurrent and short-circuit protected.

Mechanics

Housing	Rectangular
Dimensions (W x H x D)	12 mm x 31.5 mm x 21 mm
Connection	Male connector M8, 4-pin
Material	
Housing	Plastic, ABS/PC
Front screen	Plastic, PMMA
Weight	20 g

Ambient data

Enclosure rating	IP67
Ambient operating temperature	$-25\text{ °C} \dots +55\text{ °C}$ ¹⁾
Ambient temperature, storage	$-40\text{ °C} \dots +70\text{ °C}$
UL File No.	NRKH.E348498 & NRKH7.E348498

¹⁾ Temperature stability following adjustment $\pm 10\text{ °C}$.

Certificates

EU declaration of conformity	✓
UK declaration of conformity	✓

ACMA declaration of conformity	✓
Moroccan declaration of conformity	✓
China RoHS	✓
cULus certificate	✓
Photobiological safety (DIN EN 62471) certificate	✓

Classifications

ECLASS 5.0	27270904
ECLASS 5.1.4	27270904
ECLASS 6.0	27270904
ECLASS 6.2	27270904
ECLASS 7.0	27270904
ECLASS 8.0	27270904
ECLASS 8.1	27270904
ECLASS 9.0	27270904
ECLASS 10.0	27270904
ECLASS 11.0	27270904
ECLASS 12.0	27270903
ETIM 5.0	EC002719
ETIM 6.0	EC002719
ETIM 7.0	EC002719
ETIM 8.0	EC002719
UNSPSC 16.0901	39121528

Dimensional drawing

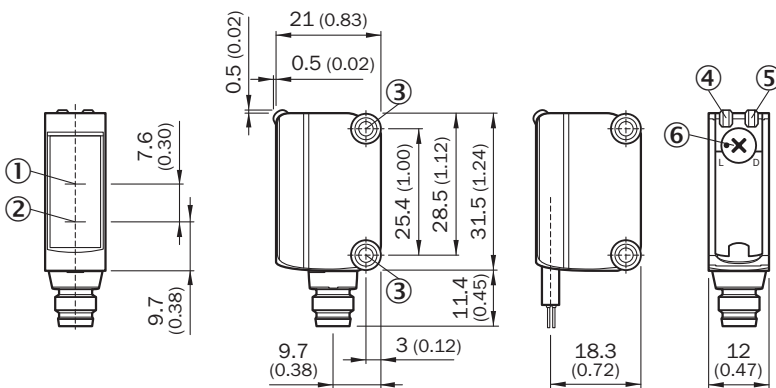

Dimensions in mm (inch)

- ① Optical axis, receiver
- ② Optical axis, sender
- ③ Mounting holes M3
- ④ LED indicator green: Supply voltage active
- ⑤ LED indicator yellow: Status of received light beam
- ⑥ Light/ dark rotary switch: L = light switching, D = dark switching

Adjustments Adjustment possibility



- ④ LED indicator green: Supply voltage active
- ⑤ LED indicator yellow: Status of received light beam
- ⑦ Sensitivity control: potentiometer

Connection type



Connection diagram Cd-066

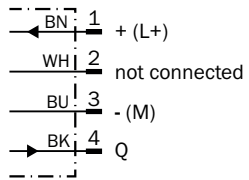

Characteristic curve GTB6



- ① object with 90% remission (based on standard white, DIN 5033)
- ② Sensing range on gray, 18% remission factor
- ③ Sensing range on black, 6% remission factor

Light spot size GTB6

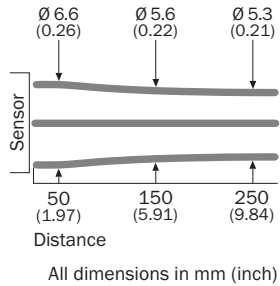



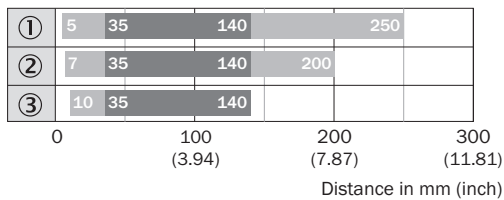



Sensing range diagram GTB6



- Sensing range max.
- Sensing range
- ① object with 90% remission (based on standard white, DIN 5033)
- ② Sensing range on gray, 18% remission factor
- ③ Sensing range on black, 6% remission factor

Recommended accessories

Other models and accessories → www.sick.com/G6

	Brief description	Type	part no.
Mounting systems			
	<ul style="list-style-type: none"> Description: Clamp bar to fix G6 sensors on rods of 12 mm, clamp-on design up to 4 mm wall thickness Material: Steel Details: Aluminum (clamp bar), stainless steel (bracket) Items supplied: Clamp bar mounting and clamp function, mounting bracket, mounting hardware 	BEF-KHS-IS12G6	2086865
	<ul style="list-style-type: none"> Material: Stainless steel Details: Stainless steel (1.4301) Suitable for: W4S, W4S 	BEF-WN-G6	2062909
	<ul style="list-style-type: none"> Description: Mounting bracket for wall mounting Material: Stainless steel Details: Stainless steel Items supplied: Mounting hardware included Suitable for: W8, W8G, W8 Laser, W8 Inox, G6, G6 Inox, W100 Laser, W100-2, KTM Core, KTM Prime, CSM, LUTM, W4S 	BEF-W100-A	5311520
connectors and cables			
	<ul style="list-style-type: none"> Connection type head A: Female connector, M8, 4-pin, straight, A-coded Connection type head B: Flying leads Signal type: Sensor/actuator cable Cable: 5 m, 4-wire, PVC Description: Sensor/actuator cable, unshielded Application: Uncontaminated zones, Zones with chemicals 	YF8U14-050VA3XLEAX	2095889
	<ul style="list-style-type: none"> Connection type head A: Female connector, M8, 4-pin, straight, A-coded Connection type head B: Flying leads Signal type: Sensor/actuator cable Cable: 5 m, 4-wire, PUR, halogen-free Description: Sensor/actuator cable, unshielded Application: Drag chain operation, Zones with oils and lubricants, Robot, Drag chain operation 	YF8U14-050UA3XLEAX	2094792
	<ul style="list-style-type: none"> Description: Unshielded Connection type head A: Male connector, M8, 4-pin, straight, A-coded Connection systems: Screw-type terminals Permitted cross-section: 0.14 mm² ... 0.5 mm² 	STE-0804-G	6037323

SICK AT A GLANCE

SICK is one of the leading manufacturers of intelligent sensors and sensor solutions for industrial applications. A unique range of products and services creates the perfect basis for controlling processes securely and efficiently, protecting individuals from accidents and preventing damage to the environment.

We have extensive experience in a wide range of industries and understand their processes and requirements. With intelligent sensors, we can deliver exactly what our customers need. In application centers in Europe, Asia and North America, system solutions are tested and optimized in accordance with customer specifications. All this makes us a reliable supplier and development partner.

Comprehensive services complete our offering: SICK LifeTime Services provide support throughout the machine life cycle and ensure safety and productivity.

For us, that is “Sensor Intelligence.”

WORLDWIDE PRESENCE:

Contacts and other locations –www.sick.com