



MICS3-CBUZ40IZ1P01

outdoorScan3

SAFETY LASER SCANNERS

SICK
Sensor Intelligence.



Illustration may differ



Ordering information

Type	part no.
MICS3-CBUZ40IZ1P01	1094472

Other models and accessories → www.sick.com/outdoorScan3

Detailed technical data

Features

Product version	outdoorScan3 Pro - EtherNet/IP
Model	Sensor including system plug (pre-mounted on the underside)
Application	1) Outdoor
Compressed air cleaning	Not possible
Protective field range	4 m
Warning field range	40 m
Number of simultaneously monitored fields	≤ 8 ²⁾
Number of fields	128
Number of monitoring cases	128
Scanning angle	275°
Resolution (can be configured)	50 mm 70 mm
Angular resolution	0.39°
Response time	115 ms
Protective field supplement	65 mm

1) The safety laser scanner is suitable for use in industrial environments (indoors and outdoors).

2) Protection or warning fields.

Safety-related parameters

Type	Type 3 (IEC 61496)
Safety integrity level	SIL 2 (IEC 61508)
Category	Category 3 (EN ISO 13849)
Performance level	PL d (EN ISO 13849)
Performance class SRS/SRSS	Performance class D (IEC/TS 62998)

PFH_D (mean probability of a dangerous failure per hour)	8.0 x 10 ⁻⁸
T_M (mission time)	20 years (EN ISO 13849)
Safe state in the event of a fault	The safety outputs via the network are logic 0.

Functions

Restart interlock	✓
Multiple sampling	✓
Monitoring case switching	✓
Simultaneous monitoring	✓
Static protective field switching	✓
Integrated configuration memory	✓
Measured data output	Via Ethernet

Interfaces

Connection type	
Voltage supply	1 x male connector, M12, 4-pin, A-coded
Fieldbus, industrial network	2 x M12 female connectors, 4-pin, D-coded
Outputs	
OSSD pairs	0
Safety outputs via network	8
Configuration method	PC with Safety Designer (Configuration and Diagnostic Software)
Configuration and diagnostics interface	USB 2.0, Mini-USB, Ethernet
Fieldbus, industrial network	EtherNet/IP™
Supported protocol versions	Common Industrial Protocol: The CIP Networks Library Volume 1, Edition 3.20
	EtherNet/IP™: The CIP Networks Library Volume 2, Edition 1.26
	CIP Safety™: The CIP Networks Library Volume 5, Edition 2.13
Topology support	DLR (Device Level Ring)
Display elements	Graphic color display, LEDs

Electronics

Protection class	III (EN 61140)
Supply voltage V_s	24 V DC (16.8 V DC ... 30 V DC)
Power consumption typical	7.2 W

Mechanics

Dimensions (W x H x D)	114.6 mm x 150.7 mm x 114.6 mm (without system plug)
Weight	1.45 kg
Housing material	Aluminum
Housing color	RAL 2004 (pure orange), RAL 9005 (black)
Optics cover material	Polycarbonate
Optics cover surface finish	Outside with scratch-resistant coating

Ambient data

Enclosure rating	IP65 (IEC 60529)
-------------------------	------------------

¹⁾ More detailed data can be found in the operating instructions, chapter "Project planning".

Ambient light immunity		
	Halogen light	12,000 lx (IEC 61496-3)
	Sunlight	40,000 lx (IEC 61496-3)
Ambient operating temperature		-25 °C ... +50 °C
Storage temperature		-25 °C ... +70 °C
Ambient conditions		
	Rain	10 mm/h ¹⁾
	Snowfall	3 mm/h SWE, Snow Water Equivalent ¹⁾
	Fog	50 m (MOR, Meteorological Optical Range) ¹⁾
Vibration resistance		IEC 60068-2-6, IEC 60068-2-64, IEC 60721-3-5, IEC TR 60721-4-3, IEC 61496-1, IEC 61496-3
	Class	5M1 (IEC 60721-3-5) 3M4 (IEC TR 60721-4-3)
Shock resistance		IEC 60068-2-27, IEC 60721-3-5, IEC TR 60721-4-3, IEC 61496-1, IEC 61496-3
	Class	5M1 (IEC 60721-3-5) 3M4 (IEC TR 60721-4-3)
	Continuous shock	100 m/s ² , 16 ms 150 m/s ² , 6 ms
EMC		IEC 61496-1, IEC 61000-6-2, IEC 61000-6-4

¹⁾ More detailed data can be found in the operating instructions, chapter "Project planning".

Other information

Type of light	Pulsed laser diode
Wave length	845 nm
Detectable remission factor	1.8% to several 1000%
Laser class	1 (21 CFR 1040.10 and 1040.11, IEC 60825-1)

Certificates

EU declaration of conformity	✓
UK declaration of conformity	✓
ACMA declaration of conformity	✓
China RoHS	✓
cULus certificate	✓
EC-Type-Examination approval	✓
Information according to Art. 3 of Data Act (Regulation EU 2023/2854)	✓

Classifications

ECLASS 5.0	27272705
ECLASS 5.1.4	27272705
ECLASS 6.0	27272705
ECLASS 6.2	27272705
ECLASS 7.0	27272705
ECLASS 8.0	27272705

ECLASS 8.1	27272705
ECLASS 9.0	27272705
ECLASS 10.0	27272705
ECLASS 11.0	27272705
ECLASS 12.0	27272705
ETIM 5.0	EC002550
ETIM 6.0	EC002550
ETIM 7.0	EC002550
ETIM 8.0	EC002550
UNSPSC 16.0901	39121528

Dimensional drawing

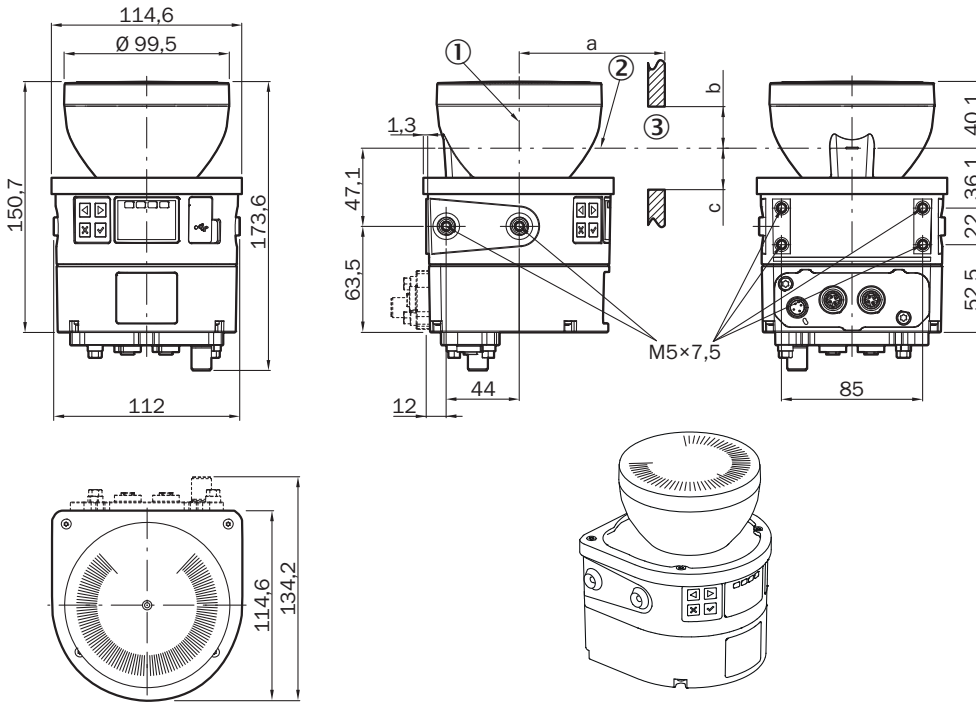

Dimensions in mm (inch)

① mirror axis of rotation

② scan plane

③ required viewing slit (a: length of the viewing slit, b: minimum height above the scan plane, c: minimum height below the scan plane. See the operating instructions for details.)

Pinouts Voltage supply (XD1)

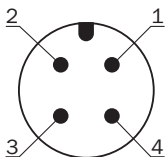

Pin	Designation	Description
1	+24 V DC	Supply voltage +24 V DC
2	n.c.	Not connected
3	0 V DC	Supply voltage 0 V DC
4	FE	Functional earth/shielding
For details see operating instructions		

Pinouts Ethernet (XF1, XF2)

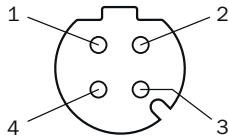





Pin	Designation	Description
1	TX+	Send data +
2	RX+	Receive data +
3	TX-	Send data -
4	RX-	Receive data -
Thread	SH	Shielding
For details see operating instructions		

Recommended accessories

Other models and accessories → www.sick.com/outdoorScan3

	Brief description	Type	part no.
Mounting systems			
	<ul style="list-style-type: none"> Description: Mounting bracket Material: Stainless steel Details: Stainless steel V2A (1.4301), powder-coated IGP-DURA face 5803A Color: RAL 9005 (black) Packing unit: 1 piece 	Mounting kit 1a	2073851
	<ul style="list-style-type: none"> Description: Mounting bracket with protection of optics hood Material: Stainless steel Details: Stainless steel V2A (1.4301), powder-coated IGP-DURA face 5803A Color: RAL 9005 (black) Packing unit: 1 piece 	1b mounting kit	2074242
	<ul style="list-style-type: none"> Description: Alignment bracket, alignment with cross-wise axis and depth axis possible, distance between mounting surface and device: 22.3 mm, only in conjunction with mounting kit 1a (2073851) or 1b (2074242) Material: Stainless steel Details: Stainless steel V2A (1.4301), powder-coated IGP-DURA face 5803A Color: RAL 9005 (black) Packing unit: 1 piece 	Mounting kit 2a	2073852
	<ul style="list-style-type: none"> Description: Alignment bracket, alignment with cross-wise axis and depth axis possible, distance between mounting surface and device: 52.3 mm, only in conjunction with mounting kit 1a (2073851) or 1b (2074242) Material: Stainless steel Details: Stainless steel V2A (1.4301), powder-coated IGP-DURA face 5803A Color: RAL 9005 (black) Packing unit: 1 piece 	Mounting kit 2b	2074184
	<ul style="list-style-type: none"> Description: Alignment bracket with protection for the optics cover, alignment with cross-wise axis and depth axis possible Packing unit: 1 piece 	Mounting kit 3	2103049
	<ul style="list-style-type: none"> Description: For loosening and tightening M12 plug connectors to the system plug with defined torque (0,4 Nm) 	Torque screwdriver with attachment for M12 plug connector	2081618
device protection and care			
	<ul style="list-style-type: none"> Description: Weather hood (only in conjunction with mounting kit 3) 	Weather hood	2103050
	<ul style="list-style-type: none"> Description: Splash guard, only in conjunction with mounting kit 3 (2103049) 	Splash guard	2123205

	Brief description	Type	part no.
connectors and cables			
	<ul style="list-style-type: none"> Connection type head A: Female connector, M12, 4-pin, angled, A-coded Connection type head B: Flying leads Signal type: Sensor/actuator cable Cable: 2 m, 4-wire, PUR, halogen-free Description: Sensor/actuator cable, shielded Application: Drag chain operation, Zones with oils and lubricants, Robot, cold bending resistant, seawater resistant, cold bending resistant 	YG2A64-020UE1XLEAX	2108122
	<ul style="list-style-type: none"> Connection type head A: Female connector, M12, 4-pin, angled, A-coded Connection type head B: Flying leads Signal type: Sensor/actuator cable Cable: 10 m, 4-wire, PUR, halogen-free Description: Sensor/actuator cable, shielded Application: Drag chain operation, Zones with oils and lubricants, Robot, cold bending resistant, seawater resistant, cold bending resistant 	YG2A64-100UE1XLEAX	2108123
	<ul style="list-style-type: none"> Connection type head A: Male connector, M12, 4-pin, angled, D-coded Connection type head B: Male connector, RJ45, 4-pin, straight Signal type: Ethernet, PROFINET Cable: 2 m, 4-wire, CAT5, PUR, halogen-free Description: Ethernet, shielded, PROFINET Application: Cold bending resistant, Outdoor, Zones with oils and lubricants, seawater resistant 	YN2D34-020P-N4MRJA4	2108116
	<ul style="list-style-type: none"> Connection type head A: Male connector, M12, 4-pin, angled, D-coded Connection type head B: Male connector, RJ45, 4-pin, straight Signal type: Ethernet, PROFINET Cable: 10 m, 4-wire, CAT5, PUR, halogen-free Description: Ethernet, shielded, PROFINET Application: Cold bending resistant, Outdoor, Zones with oils and lubricants, seawater resistant 	YN2D34-100P-N4MRJA4	2108141
Safety systems			
	<ul style="list-style-type: none"> Product type: Software Items supplied: Software (Safety Designer project file with functional logic) as well as operating instructions 	SOW/DWA-FX00402010	1615375

SICK AT A GLANCE

SICK is one of the leading manufacturers of intelligent sensors and sensor solutions for industrial applications. A unique range of products and services creates the perfect basis for controlling processes securely and efficiently, protecting individuals from accidents and preventing damage to the environment.

We have extensive experience in a wide range of industries and understand their processes and requirements. With intelligent sensors, we can deliver exactly what our customers need. In application centers in Europe, Asia and North America, system solutions are tested and optimized in accordance with customer specifications. All this makes us a reliable supplier and development partner.

Comprehensive services complete our offering: SICK LifeTime Services provide support throughout the machine life cycle and ensure safety and productivity.

For us, that is “Sensor Intelligence.”

WORLDWIDE PRESENCE:

Contacts and other locations –www.sick.com