



# DL100-22AA2212

Dx100

TIME-OF-FLIGHT SENSORS

**SICK**  
Sensor Intelligence.



Illustration may differ



### Ordering information

Type	part no.
DL100-22AA2212	1086985

Other models and accessories → [www.sick.com/Dx100](http://www.sick.com/Dx100)

### Detailed technical data

#### Features

<b>Measuring range</b>	0.15 m ... 200 m, on "diamond grade" reflective tape
<b>Scope</b>	High Feature
<b>Target</b>	Reflector
<b>Resolution</b>	0.1 mm, 0.125 mm, 1 mm, 10 mm, 100 mm, freely adjustable
<b>Repeatability</b>	1 mm <sup>1)</sup>
<b>Measurement accuracy</b>	± 2.5 mm <sup>2)</sup>
<b>Response time</b>	2 ms
<b>Measurement cycle time</b>	1 ms
<b>Output time</b>	1 ms
<b>Emitted beam</b>	
Light source	Laser, red <sup>3)</sup>
Type of light	Visible red light
Typ. light spot size (distance)	5 mm + (2 mm x distance in m)
<b>Key laser figures</b>	
Normative reference	IEC 60825-1:2014, EN 60825-1:2014
Laser class	2 <sup>4)</sup>
<b>Max. movement speed</b>	15 m/s
<b>Acceleration (max.)</b>	≤ 15 m/s <sup>2</sup>
<b>Safety-related parameters</b>	
MTTF <sub>D</sub>	101 years

<sup>1)</sup> Statistical error 1  $\sigma$ , environmental conditions constant, min. warm-up time 10 min.

<sup>2)</sup> From 150 mm ... 180 mm measuring range the accuracy can reach ± 4 mm.

<sup>3)</sup> Average service life: 100,000 h at T<sub>J</sub> = +25 °C.

<sup>4)</sup> Do not intentionally look into the laser beam. Never point the laser beam at people's eyes.

DC<sub>avg</sub> 0%

- 1) Statistical error 1  $\sigma$ , environmental conditions constant, min. warm-up time 10 min.  
 2) From 150 mm ... 180 mm measuring range the accuracy can reach  $\pm 4$  mm.  
 3) Average service life: 100,000 h at T<sub>U</sub> = +25 °C.  
 4) Do not intentionally look into the laser beam. Never point the laser beam at people's eyes.

## Interfaces

<b>PROFINET</b>	✓
<b>Network load class</b>	III
<b>Digital output</b>	
Number	2 <sup>1)</sup>
Type	Push-pull: PNP/NPN
Function	Distance: Distance switching output
	Speed; Speed output
	Service: Warning message as the sensor ages, if the damping value is exceeded (for example when contaminated, if the permitted interior device temperature is exceeded or undercut, if the measured value has a plausibility error, if the laser is not ready for operation, if the heating is switched on
	Laser off
	Preset
Maximum output current I <sub>A</sub>	$\leq 100$ mA <sup>2)</sup>
<b>Multifunctional input (MF)</b>	1 x MF1 <sup>3)</sup>

1) HIGH =  $> V_S - 3$  V / LOW =  $< 2$  V.

2) Max. 100 nF/20 mH.

3) HIGH  $> 12$  V / LOW  $< 3$  V.

## Electronics

<b>Supply voltage U<sub>B</sub></b>	DC 18 V ... 30 V, limit values
<b>Current consumption</b>	At 24 V DC $< 250$ mA
<b>Ripple</b>	5 V <sub>pp</sub> <sup>1)</sup>
<b>Modulation frequency</b>	Fix
<b>Initialization time</b>	Typ. 1.5 s <sup>2)</sup>
<b>Display</b>	6 digit 5 x 7 dot matrix display, LEDs
<b>Enclosure rating</b>	IP65
<b>Protection class</b>	III
<b>Connection type</b>	Male connector

1) May not fall short of or exceed V<sub>S</sub> tolerances.

2) After loss of reflector  $< 40$  ms.

## Mechanics

<b>Dimensions (W x H x D)</b>	69.4 mm x 82.5 mm x 100.2 mm
<b>Housing material</b>	Metal (Aluminum die cast)
<b>Window material</b>	Plastic (PMMA)
<b>Weight</b>	Approx. 800 g (with mounting bracket: approx. 1,600 g)

## Ambient data

<b>Ambient temperature, operation</b>	-20 °C ... +55 °C <sup>1)</sup> -20 °C ... +75 °C, operation with cooling case <sup>1)</sup>
<b>Ambient temperature, storage</b>	-40 °C ... +75 °C
<b>Effect of air pressure</b>	0.3 ppm/hPa
<b>Effect of air temperature</b>	1 ppm/K
<b>Temperature drift</b>	Typ. 0.1 mm/K
<b>Typ. Ambient light immunity</b>	≤ 100,000 lx
<b>Mechanical load</b>	Shock: (EN 600 68-2-27) Sine: (EN 600 68-2-6) Noise: (EN 600 68-2-64)
<b>Electromagnetic compatibility (EMC)</b>	EN 61000-6-2, EN 61000-6-4 <sup>2)</sup>

<sup>1)</sup> Temperatures < -10 °C require warm-up time of typ. 7 minutes.

<sup>2)</sup> This is a Class A device. This device can cause radio interference in living quarters.

## Certificates

<b>EU declaration of conformity</b>	✓
<b>UK declaration of conformity</b>	✓
<b>ACMA declaration of conformity</b>	✓
<b>Moroccan declaration of conformity</b>	✓
<b>China RoHS</b>	✓
<b>cULus certificate</b>	✓
<b>Profinet certificate</b>	✓
<b>Information according to Art. 3 of Data Act (Regulation EU 2023/2854)</b>	✓

## Classifications

<b>ECLASS 5.0</b>	27270801
<b>ECLASS 5.1.4</b>	27270801
<b>ECLASS 6.0</b>	27270801
<b>ECLASS 6.2</b>	27270801
<b>ECLASS 7.0</b>	27270801
<b>ECLASS 8.0</b>	27270801
<b>ECLASS 8.1</b>	27270801
<b>ECLASS 9.0</b>	27270801
<b>ECLASS 10.0</b>	27270801
<b>ECLASS 11.0</b>	27270801
<b>ECLASS 12.0</b>	27270916
<b>ETIM 5.0</b>	EC001825
<b>ETIM 6.0</b>	EC001825
<b>ETIM 7.0</b>	EC001825
<b>ETIM 8.0</b>	EC001825
<b>UNSPSC 16.0901</b>	41111613

Dimensional drawing

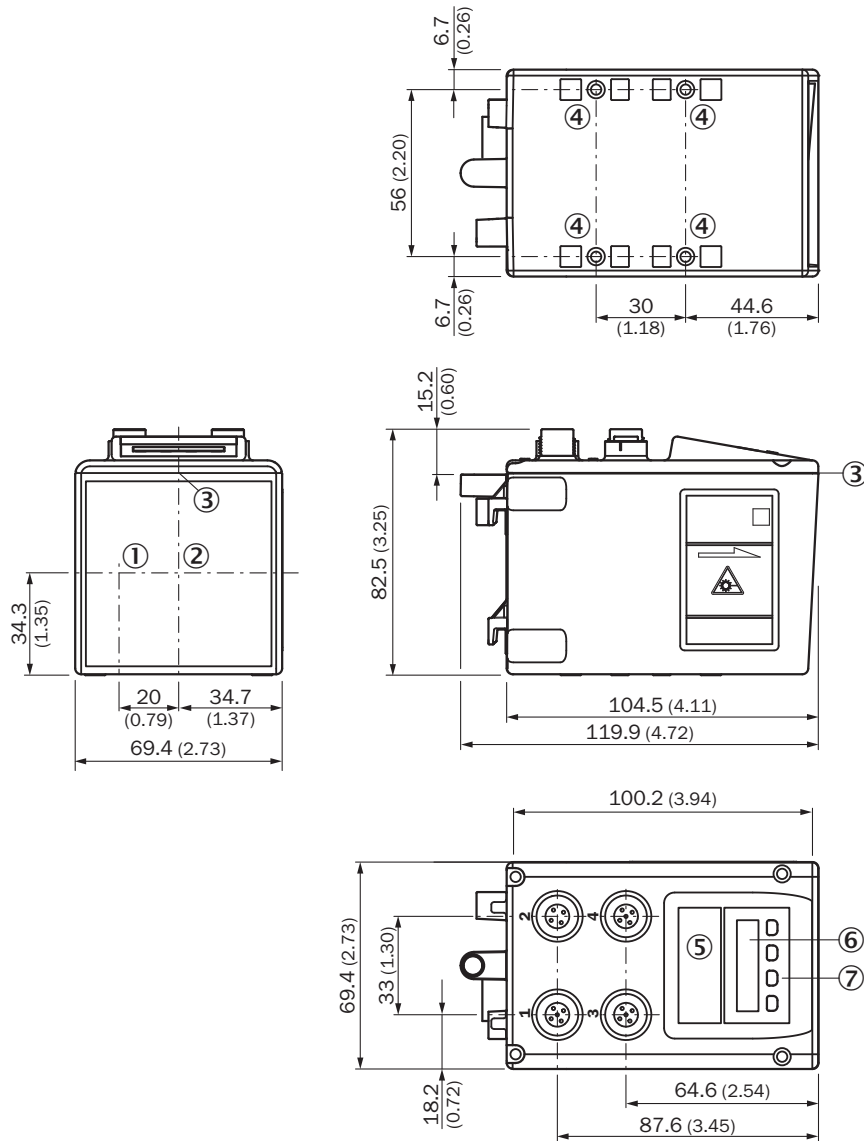

- Dimensions in mm (inch)
- ① Optical axis, sender
  - ② Optical axis, receiver
  - ③ Zero level
  - ④ Threaded mounting hole M5
  - ⑤ status LED [status]
  - ⑥ Display
  - ⑦ Control elements

Ethernet connection type

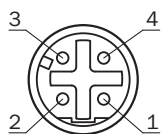

### Voltage supply connection type

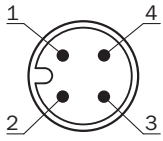

### PROFINET port 1, port 2 connection type

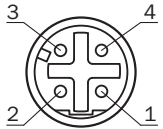

### Voltage supply connection diagram

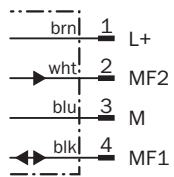

### Ethernet connection diagram

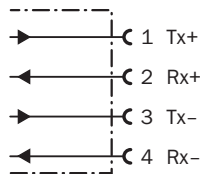



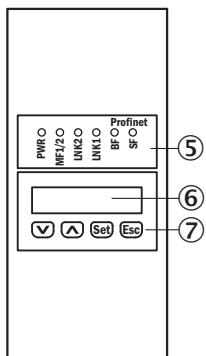

### Adjustment possible DL100-xxxxxx12



- ⑤ status LED [status]
- ⑥ Display
- ⑦ Control elements

## Recommended accessories

Other models and accessories → [www.sick.com/Dx100](http://www.sick.com/Dx100)

	Brief description	Type	part no.
reflectors and optics			
	<ul style="list-style-type: none"> <li><b>Description:</b> Reflector plate, "diamond grade" reflective tape, 665 mm x 665 mm, base plate material: aluminum, screw connection</li> <li><b>Ambient operating temperature:</b> -25 °C ... +65 °C</li> </ul>	PL560DG	1016806
	<ul style="list-style-type: none"> <li><b>Description:</b> Reflector plate, "diamond grade" reflective tape, 330 mm x 330 mm, base plate material: aluminum, screw connection</li> <li><b>Ambient operating temperature:</b> -34 °C ... +70 °C</li> </ul>	PL240DG	1017910
Mounting systems			
	<ul style="list-style-type: none"> <li><b>Description:</b> Alignment unit for Dx100, incl. mounting material</li> <li><b>Material:</b> Steel</li> <li><b>Details:</b> Steel, zinc coated</li> </ul>	BEF-AH-DX100	2058653
connectors and cables			
	<ul style="list-style-type: none"> <li><b>Connection type head A:</b> Female connector, M12, 4-pin, straight, A-coded</li> <li><b>Connection type head B:</b> Flying leads</li> <li><b>Signal type:</b> Sensor/actuator cable</li> <li><b>Cable:</b> 5 m, 4-wire, PVC</li> <li><b>Description:</b> Sensor/actuator cable, unshielded</li> <li><b>Application:</b> Uncontaminated zones, Zones with chemicals</li> </ul>	YF2A14-050VB3XLEAX	2096235
	<ul style="list-style-type: none"> <li><b>Connection type head A:</b> Male connector, M12, 4-pin, straight, D-coded</li> <li><b>Connection type head B:</b> Flying leads</li> <li><b>Signal type:</b> Ethernet, PROFINET</li> <li><b>Cable:</b> 5 m, 4-wire, PUR, halogen-free</li> <li><b>Description:</b> Ethernet, shielded, PROFINET</li> <li><b>Application:</b> Drag chain operation, Zones with oils and lubricants</li> </ul>	YM2D24-050P-N1XLEAX	2106172

## SICK AT A GLANCE

SICK is one of the leading manufacturers of intelligent sensors and sensor solutions for industrial applications. A unique range of products and services creates the perfect basis for controlling processes securely and efficiently, protecting individuals from accidents and preventing damage to the environment.

We have extensive experience in a wide range of industries and understand their processes and requirements. With intelligent sensors, we can deliver exactly what our customers need. In application centers in Europe, Asia and North America, system solutions are tested and optimized in accordance with customer specifications. All this makes us a reliable supplier and development partner.

Comprehensive services complete our offering: SICK LifeTime Services provide support throughout the machine life cycle and ensure safety and productivity.

For us, that is “Sensor Intelligence.”

## WORLDWIDE PRESENCE:

Contacts and other locations –[www.sick.com](http://www.sick.com)