



KTM-WP11173P

KTM

CONTRAST SENSORS

SICK
Sensor Intelligence.



Illustration may differ



Ordering information

| Type | part no. |
|--------------|----------|
| KTM-WP11173P | 1084942 |

Other models and accessories → www.sick.com/KTM

Detailed technical data

Features

| | |
|-----------------------------------|---|
| Housing design | Small |
| Dimensions (W x H x D) | 12 mm x 31.5 mm x 21 mm |
| Light source | LED, RGB ¹⁾ |
| Light emission | Long side of housing |
| Light spot size | 1.6 mm x 9.5 mm |
| Light spot direction | Vertical ²⁾ |
| Receiving filters | None |
| Wave length | 470 nm, 525 nm, 625 nm |
| Sensing distance | ≤ 12.5 mm |
| Sensing distance tolerance | ± 3 mm |
| Display | LED indicator green: power on LED indicator, yellow: Status switching output Q |
| Adjustment | Teach-in button |
| Teach-in mode | 2-point teach-in static/dynamic + proximity to mark ET: Teach-in static |

¹⁾ Average service life: 100,000 h at T_J = +25 °C.

²⁾ In relation to long side of housing.

Electronics

| | |
|-----------------------|-----------------------------------|
| Supply voltage | 12 V DC ... 24 V DC ¹⁾ |
|-----------------------|-----------------------------------|

¹⁾ Limit values: DC 12 V (-10 %) ... DC 24 V (+20 %). Operation in short-circuit protected network max. 8 A.

²⁾ May not fall below or exceed U_y tolerances.

³⁾ Without load.

⁴⁾ With light/dark ratio 1:1.

⁵⁾ Total current of all Outputs.

| | |
|--|---|
| Ripple | $\leq 5 V_{pp}$ ²⁾ |
| Current consumption | $< 50 \text{ mA}$ ³⁾ |
| Switching frequency | 15 kHz ⁴⁾ |
| Response time | 32 μs |
| Jitter | 15 μs |
| Switching output | PNP |
| Switching output (voltage) | PNP: HIGH = $U_V \leq 2 \text{ V}$ / LOW approx. 0 V |
| Switching mode | Light/dark switching |
| Output current I_{max} | 50 mA ⁵⁾ |
| Input, static teach-in (ET) | PNP: Teach: $U = 10,8 \text{ V} \dots < U_V$ PNP: Run: $U < 2 \text{ V}$ or open |
| Retention time (ET) | 28 ms, non-volatile memory |
| Time delay | None |
| Protection class | III |
| Circuit protection | U_V connections, reverse polarity protected Output Q short-circuit protected Interference pulse suppression |
| Connection type | Cable with M8 male connector, 4-pin, 0.2 m |

¹⁾ Limit values: DC 12 V (-10 %) ... DC 24 V (+20 %). Operation in short-circuit protected network max. 8 A.

²⁾ May not fall below or exceed U_V tolerances.

³⁾ Without load.

⁴⁾ With light/dark ratio 1:1.

⁵⁾ Total current of all Outputs.

Mechanics

| | |
|-------------------------|------|
| Housing material | ABS |
| Optics material | PMMA |
| Weight | 20 g |

Ambient data

| | |
|--------------------------------------|------------------------------|
| Ambient operating temperature | -10 °C ... +55 °C |
| Ambient temperature, storage | -20 °C ... +75 °C |
| Shock load | According to IEC 60068 |
| Enclosure rating | IP67 |
| UL File No. | NRKH.E348498 & NRKH7.E348498 |

Connection type/pinouts

| | |
|------------------------|--|
| Connection type | Cable with M8 male connector, 4-pin, 0.2 m |
| Pinouts | |
| BN 1 | + (L+) |
| WH 2 | ET |
| BU 3 | - (M) |
| BK 4 | Q |

Classifications

| | |
|-----------------------|----------|
| ECLASS 5.0 | 27270906 |
| ECLASS 5.1.4 | 27270906 |
| ECLASS 6.0 | 27270906 |
| ECLASS 6.2 | 27270906 |
| ECLASS 7.0 | 27270906 |
| ECLASS 8.0 | 27270906 |
| ECLASS 8.1 | 27270906 |
| ECLASS 9.0 | 27270906 |
| ECLASS 10.0 | 27270906 |
| ECLASS 11.0 | 27270906 |
| ECLASS 12.0 | 27270906 |
| ETIM 5.0 | EC001820 |
| ETIM 6.0 | EC001820 |
| ETIM 7.0 | EC001820 |
| ETIM 8.0 | EC001820 |
| UNSPSC 16.0901 | 39121528 |

Certificates

| | |
|--|---|
| EU declaration of conformity | ✓ |
| UK declaration of conformity | ✓ |
| ACMA declaration of conformity | ✓ |
| Moroccan declaration of conformity | ✓ |
| China RoHS | ✓ |
| cULus certificate | ✓ |
| Photobiological safety (IEC EN 62471) | ✓ |

Dimensional drawing KTM-Mxxxxx3P, KTM-Wxxxxx3P

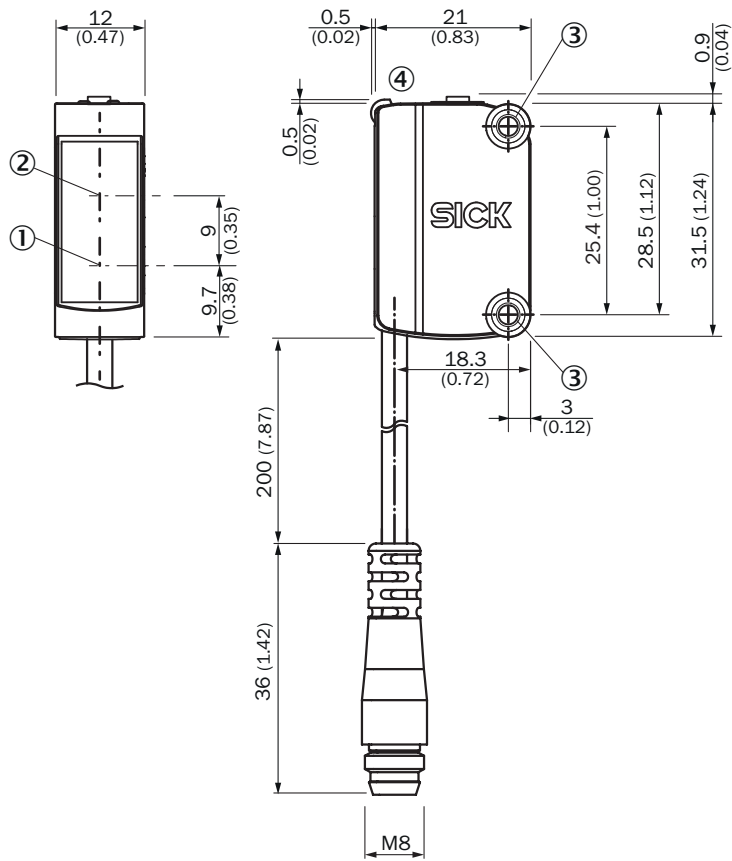

Dimensions in mm (inch)

- ① Center of optical axis, sender
- ② Center of optical axis, receiver
- ③ Mounting holes M3
- ④ display and adjustment elements

Pinouts, see table [Technical data: Connection type/pinouts](#)

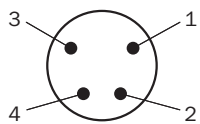

Male connector, M8, 4-pin, uncoded

display and adjustment elements

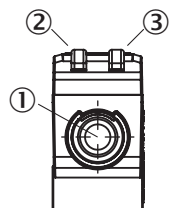

- ① Teach-in button
- ② LED yellow
- ③ LED green

Setting the switching threshold (static)

1. Position mark

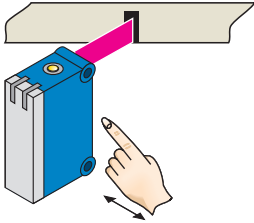

Press and hold teach-in button $> 1 < 3$ s.
Yellow LED flashes slowly.

2. Position background

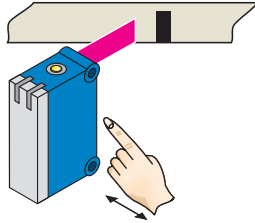

Press and hold teach-in button < 3 s.
Yellow LED goes out.

Setting the switching threshold (dynamic)

1. Position background

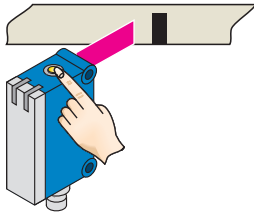

Press the teach-in button and keep it pressed. LED flashing slowly.

2. Move at least the mark and background using the light spot.

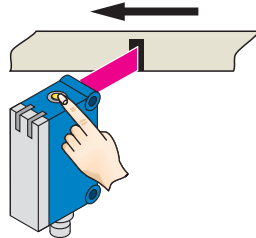

Keep the teach-in button > 3 < 30 s pressed.

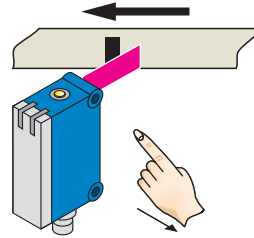

Release the teach-in button.

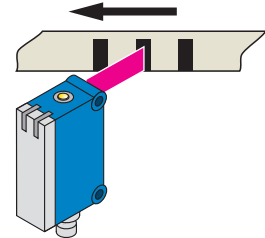

Yellow LED will illuminate, when emitted light is on the mark.

Example

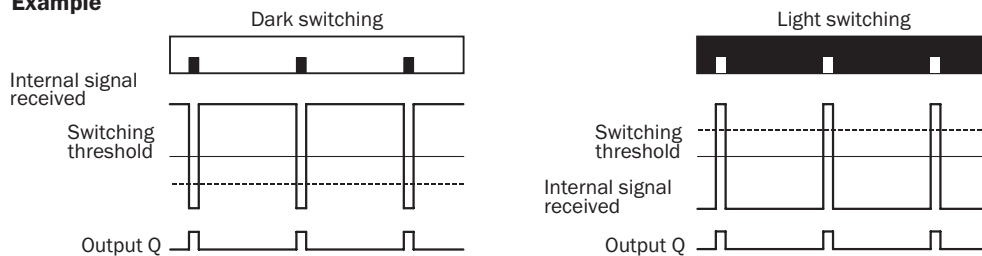

Switching characteristics

The optimum emitted light is selected automatically (at RGB variants).

Static teach-in: light/dark setting is defined using teach-in sequence.

Dynamic teach-in: switching output active on mark, if background is longer in the field of view during the teach-in.

The switching threshold is set in the center between the background and the mark.

If the button is pressed again within 10 s of the teach (> 20 ms < 10 s), the relative switching threshold is placed 75 % between mark (100 %) and background (0 %) (dotted line in Figure).

Teach-in can also be performed using an external control signal.

Keylock activation and deactivation: hold down teach-in button > 30 s.

Teach-in failure: yellow LED indicator and the transmitted light of the sensor flashing quickly.

For dynamic teach-in with ET signal (5 Hz) via switching output Q.

Sensing distance

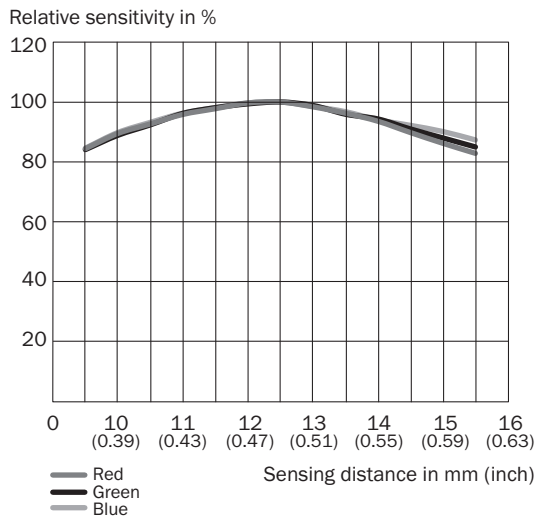

Recommended accessories

Other models and accessories → www.sick.com/KTM

| | Brief description | Type | part no. |
|---|---|------------|----------|
| Mounting systems | | | |
|  | <ul style="list-style-type: none"> Description: Mounting bracket for wall mounting Material: Stainless steel Details: Stainless steel Items supplied: Mounting hardware included Suitable for: W8, W8G, W8 Laser, W8 Inox, G6, G6 Inox, W100 Laser, W100-2, KTM Core, KTM Prime, CSM, LUTM, W4S | BEF-W100-A | 5311520 |

SICK AT A GLANCE

SICK is one of the leading manufacturers of intelligent sensors and sensor solutions for industrial applications. A unique range of products and services creates the perfect basis for controlling processes securely and efficiently, protecting individuals from accidents and preventing damage to the environment.

We have extensive experience in a wide range of industries and understand their processes and requirements. With intelligent sensors, we can deliver exactly what our customers need. In application centers in Europe, Asia and North America, system solutions are tested and optimized in accordance with customer specifications. All this makes us a reliable supplier and development partner.

Comprehensive services complete our offering: SICK LifeTime Services provide support throughout the machine life cycle and ensure safety and productivity.

For us, that is “Sensor Intelligence.”

WORLDWIDE PRESENCE:

Contacts and other locations –www.sick.com