



# IQ40-40NNPKCOK

IQG

INDUCTIVE PROXIMITY SENSORS

**SICK**  
Sensor Intelligence.



## Ordering information

Type	part no.
IQ40-40NNPKCOK	1071864

**Included in delivery:** BEF-KH-IQ40 (1)

Other models and accessories → [www.sick.com/IQG](http://www.sick.com/IQG)



## Detailed technical data

### Features

<b>Housing</b>	Rectangular
<b>Housing</b>	Short-body
<b>Dimensions (W x H x D)</b>	40 mm x 40 mm x 66 mm
<b>Sensing range <math>S_n</math></b>	40 mm
<b>Safe sensing range <math>S_a</math></b>	32.4 mm
<b>Installation type</b>	Non-flush
<b>Switching frequency</b>	100 Hz
<b>Connection type</b>	Male connector M12, 4-pin
<b>Switching output</b>	NPN
<b>Switching output detail</b>	NPN
<b>Output function</b>	Complementary
<b>Electrical wiring</b>	DC 4-wire
<b>Enclosure rating</b>	IP67, IP68, IP69K
<b>Special applications</b>	Difficult application conditions
<b>Items supplied</b>	Push-lock mounting system (1x)

### Mechanics/electronics

<b>Supply voltage</b>	10 V DC ... 30 V DC
<b>Ripple</b>	$\leq 10 V_{pp}^{1)}$
<b>Voltage drop</b>	$\leq 2 V$
<b>Time delay before availability</b>	$\leq 200 ms$
<b>Hysteresis</b>	3 % ... 15 % <sup>2)</sup>
<b>Reproducibility</b>	$\leq 6 \%$

<sup>1)</sup> Of  $U_b$ .

<sup>2)</sup> Of  $S_r$ .

<sup>3)</sup> Reference voltage: 50 V DC.

<b>Temperature drift (of <math>S_r</math>)</b>	$\pm 10 \%$
<b>Continuous current <math>I_a</math></b>	$\leq 200 \text{ mA}$
<b>No load current</b>	12.5 mA
<b>Short-circuit protection</b>	✓
<b>Power-up pulse protection</b>	✓
<b>Shock and vibration resistance</b>	30 g, 11 ms / 10 ... 55 Hz, 1 mm
<b>Ambient operating temperature</b>	-25 °C ... +85 °C
<b>Ambient temperature, storage</b>	-40 °C ... +85 °C
<b>Housing material</b>	Plastic, PA 66
<b>Sensing face material</b>	Plastic, PA 66
<b>Tightening torque, max.</b>	1.8 Nm
<b>Protection class</b>	II <sup>3)</sup>
<b>UL File No.</b>	E348498

1) Of  $U_b$ .

2) Of  $S_r$ .

3) Reference voltage: 50 V DC.

### Safety-related parameters

<b>MTTF<sub>D</sub></b>	1,125 years
<b>DC<sub>avg</sub></b>	0 %
<b>T<sub>M</sub> (mission time)</b>	20 years

### Reduction factors

<b>Note</b>	The values are reference values which may vary
<b>Stainless steel (V2A, 304)</b>	Approx. 0.8
<b>Aluminum (Al)</b>	Approx. 0.34
<b>Copper (Cu)</b>	Approx. 0.27
<b>Brass (Br)</b>	Approx. 0.38

### Installation note

<b>Remark</b>	Associated graphic see "Installation"
<b>A</b>	42 mm
<b>B</b>	150 mm
<b>C</b>	40 mm
<b>D</b>	120 mm
<b>E</b>	40 mm
<b>F</b>	150 mm

### Certificates

<b>EU declaration of conformity</b>	✓
<b>UK declaration of conformity</b>	✓
<b>ACMA declaration of conformity</b>	✓
<b>Moroccan declaration of conformity</b>	✓
<b>China RoHS</b>	✓

<b>cULus certificate</b>	✓
--------------------------	---

Classifications

<b>ECLASS 5.0</b>	27270101
<b>ECLASS 5.1.4</b>	27270101
<b>ECLASS 6.0</b>	27270101
<b>ECLASS 6.2</b>	27270101
<b>ECLASS 7.0</b>	27270101
<b>ECLASS 8.0</b>	27270101
<b>ECLASS 8.1</b>	27270101
<b>ECLASS 9.0</b>	27270101
<b>ECLASS 10.0</b>	27270101
<b>ECLASS 11.0</b>	27270101
<b>ECLASS 12.0</b>	27274001
<b>ETIM 5.0</b>	EC002714
<b>ETIM 6.0</b>	EC002714
<b>ETIM 7.0</b>	EC002714
<b>ETIM 8.0</b>	EC002714
<b>UNSPSC 16.0901</b>	39122230

Installation note



Connection diagram Cd-009

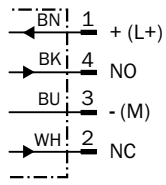

Response diagram

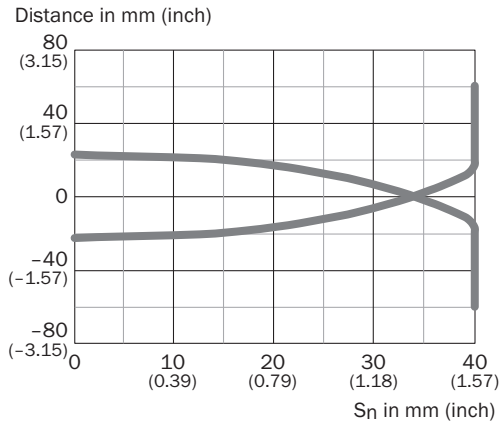



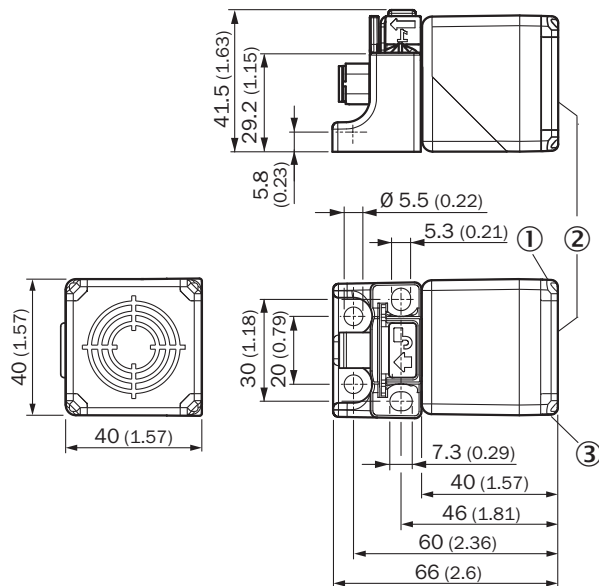

Dimensional drawing IQG Short-body housing



- ① LED output state, yellow
- ② Sensing face
- ③ operational status LED, green

Recommended accessories

Other models and accessories → [www.sick.com/IQG](http://www.sick.com/IQG)

	Brief description	Type	part no.
connectors and cables			
	<ul style="list-style-type: none"> <li><b>Description:</b> Unshielded</li> <li><b>Connection type head A:</b> Female connector, M12, 4-pin, straight, A-coded</li> <li><b>Connection systems:</b> Screw-type terminals</li> <li><b>Permitted cross-section:</b> ≤ 0.75 mm<sup>2</sup></li> </ul>	DOS-1204-G	6007302
	<ul style="list-style-type: none"> <li><b>Description:</b> Unshielded</li> <li><b>Connection type head A:</b> Male connector, M12, 4-pin, straight, A-coded</li> <li><b>Connection systems:</b> Screw-type terminals</li> <li><b>Permitted cross-section:</b> ≤ 0.75 mm<sup>2</sup></li> </ul>	STE-1204-G	6009932
	<ul style="list-style-type: none"> <li><b>Description:</b> Sensor/actuator cable, unshielded</li> <li><b>Connection type head A:</b> Female connector, M12, 4-pin, straight, A-coded</li> <li><b>Connection type head B:</b> Flying leads</li> <li><b>Signal type:</b> Sensor/actuator cable</li> <li><b>Cable:</b> 5 m, 4-wire, PVC</li> <li><b>Application:</b> Untaminated zones, Zones with chemicals</li> </ul>	YF2A14-050VB3XLEAX	2096235
	<ul style="list-style-type: none"> <li><b>Description:</b> Sensor/actuator cable, unshielded</li> <li><b>Connection type head A:</b> Female connector, M12, 4-pin, angled, A-coded</li> <li><b>Connection type head B:</b> Flying leads</li> <li><b>Signal type:</b> Sensor/actuator cable</li> <li><b>Cable:</b> 5 m, 4-wire, PVC</li> <li><b>Application:</b> Untaminated zones, Zones with chemicals</li> </ul>	YG2A14-050VB3XLEAX	2095897
	<ul style="list-style-type: none"> <li><b>Description:</b> Sensor/actuator cable, unshielded</li> <li><b>Connection type head A:</b> Female connector, M12, 4-pin, straight, A-coded</li> <li><b>Connection type head B:</b> Flying leads</li> <li><b>Signal type:</b> Sensor/actuator cable</li> <li><b>Cable:</b> 5 m, 4-wire, PUR, halogen-free</li> <li><b>Application:</b> Drag chain operation, Zones with oils and lubricants, Robot, Drag chain operation</li> </ul>	YF2A14-050UB3XLEAX	2095608

## SICK AT A GLANCE

SICK is one of the leading manufacturers of intelligent sensors and sensor solutions for industrial applications. A unique range of products and services creates the perfect basis for controlling processes securely and efficiently, protecting individuals from accidents and preventing damage to the environment.

We have extensive experience in a wide range of industries and understand their processes and requirements. With intelligent sensors, we can deliver exactly what our customers need. In application centers in Europe, Asia and North America, system solutions are tested and optimized in accordance with customer specifications. All this makes us a reliable supplier and development partner.

Comprehensive services complete our offering: SICK LifeTime Services provide support throughout the machine life cycle and ensure safety and productivity.

For us, that is “Sensor Intelligence.”

## WORLDWIDE PRESENCE:

Contacts and other locations –[www.sick.com](http://www.sick.com)