



V2D642R-MCXXH6

Lector64x/Lector65x

IMAGE-BASED CODE READERS

SICK
Sensor Intelligence.



Ordering information

Type	part no.
V2D642R-MCXXH6	1071472

Other models and accessories → www.sick.com/Lector64x_Lector65x



Detailed technical data

Features

Variant	Main unit
Optical focus	Adjustable focus (manual)
Sensor	CMOS monochrome
Sensor resolution	1,600 px x 1,088 px (1.7 MP)
Illumination	To be ordered separately as accessories
Alignment aid	Laser, Red, 630 nm ... 680 nm
Laser class	1, Complies with 21 CFR 1040.10 and 1040.11 except for conformance with IEC 60825-1 Ed.3., as described in "Laser Notice No. 56" dated May 8, 2019 (IEC 60825-1:2014, EN 60825-1:2014+A11:2021)
Lens	C-mount
Optical format	2/3"
Note	To be ordered separately as accessories
Scanning frequency	40 Hz, at 1.7 megapixels resolution
Code resolution	≥ 0.1 mm ¹⁾
Working range	300 mm ... 2,200 mm ^{1) 2)}

¹⁾ Depends on lens used.

²⁾ For details see field of view diagram.

Mechanics/electronics

Connection type	1 x M12, 17-pin plug (serial, CAN, I/Os, power supply) 2 x M12, 8-pin socket (Ethernet, P1 not yet with function) 1 x M8, 4-pin socket (USB)
------------------------	--

¹⁾ Housing only, without lens and optics protection hood.

Supply voltage	24 V DC, $\pm 20\%$
Power consumption	Typ. 20 W, $\pm 20\%$
Output current	≤ 100 mA
Housing material	Aluminum die cast
Housing color	Light blue (RAL 5012)
Window material	Plastic (To be ordered separately as accessories) Glass (To be ordered separately as accessories)
Enclosure rating	IP65 (EN 60529 (1991-10), EN 60529/A2 (2002-02))
Protection class	III
Electrical safety	EN 60950-1 (2011-01)
Weight	635 g
Dimensions (L x W x H)	142 mm x 89 mm x 46 mm ¹⁾
MTBF	100,000 h

¹⁾ Housing only, without lens and optics protection hood.

Performance

Readable code structures	1D codes, Stacked, 2D codes
Bar code types	GS1-128 / EAN 128, UPC / GTIN / EAN, Interleaved 2 of 5, Pharmacode, GS1 DataBar, Code 39, Code 128, Codabar, Code 32, Code 93, USPS (Postnet, Planet, USPS4SCB), Australian Post, Dutch KIX Post, Royal Mail, Swedish Post
2D code types	Data Matrix ECC200, GS1 Data-Matrix, MaxiCode, QR code
Stacked code types	PDF417
Code qualification	On the basis of ISO/IEC 16022, ISO/IEC 15415, ISO/IEC 18004
Internal image storage	512 MB

Interfaces

Ethernet	Function	✓, TCP/IP, TCP/IP
	Data transmission rate	Data interface (read result output), Service interface, FTP (image transmission) 10/100/1,000 Mbit/s
EtherNet/IP™	Function	✓
	Data transmission rate	10/100/1,000 Mbit/s
Serial	Function	✓, RS-232, RS-422
	Data transmission rate	Data interface (read result output), Service interface 0.3 kBaud ... 115.2 kBaud, AUX: 57.6 kBaud (RS-232)
CAN	Function	✓
	Data transmission rate	SICK CAN sensor network CSN (CAN controller/CAN device, multiplexer/server) 20 kbit/s ... 1 Mbit/s
PROFIBUS DP	Type of fieldbus integration	✓ Optional over external fieldbus module CDF600-2
PROFINET	Function	✓ PROFINET Single Port (integrated), PROFINET Dual Port (optional via external connection module CDF600-2)
Digital inputs		4 ("Sensor 1", "Sensor 2", 2 inputs via optional CMC600 parameter memory in CDB650/CDM420)
Configurable inputs		Encoder input, external trigger

Digital outputs	6 (CDB650: "Result 1", "Result 2", "Result 3", "Result 4", 2 external outputs via CMC600 or CDM420: "Result 1", "Result 2", 2 external outputs via CMC600 or cable with open end: "Result 1", "Result 2", "Result 3", "Result 4")
Configurable outputs	Good read, External illumination control, free configurable output condition, "device ready"
Reading pulse	Digital inputs, non-powered, serial interface, Ethernet, CAN, auto pulse, presentation mode
Optical indicators	21 LEDs (10 x status display, 10 x LED bar graph, 1 green feedback spot)
Acoustic indicators	Beeper/buzzer (can be switched off, can be assigned a function to signal a result)
Control elements	2 buttons (choose and start/stop functions)
Operator interfaces	Web server
Configuration software	SOPAS ET
Memory card	Micro SD memory card (flash card) max. 16 GB, optional
Data storage and retrieval	Image and data storage via microSD memory card and external FTP
EncoderFrequency	Max. 1 kHz
External illumination control	Via digital output (max. 24 V trigger) or external illumination connection

Ambient data

Electromagnetic compatibility (EMC)	EN 61000-6-2:2005-08 / EN 61000-6-3 (2007-01)
Vibration resistance	EN 60068-2-6:2008-02
Shock resistance	EN 60068-2-6
Ambient operating temperature	0 °C ... +50 °C
Storage temperature	-20 °C ... +70 °C
Relative humidity	90 %, Non-condensing
Ambient light immunity	2,000 lx, on code

Certificates

EU declaration of conformity	✓
UK declaration of conformity	✓
ACMA declaration of conformity	✓
China RoHS	✓
cULus certificate	✓
Profinet certificate	✓
Information according to Art. 3 of Data Act (Regulation EU 2023/2854)	✓
4Dpro	✓

Classifications

ECLASS 5.0	27280103
ECLASS 5.1.4	27280103
ECLASS 6.0	27280103
ECLASS 6.2	27280103
ECLASS 7.0	27280103
ECLASS 8.0	27280103
ECLASS 8.1	27280103
ECLASS 9.0	27280103
ECLASS 10.0	27280103

ECLASS 11.0	27280103
ECLASS 12.0	27280103
ETIM 5.0	EC002550
ETIM 6.0	EC002550
ETIM 7.0	EC002999
ETIM 8.0	EC002999
UNSPSC 16.0901	43211701

Dimensional drawing

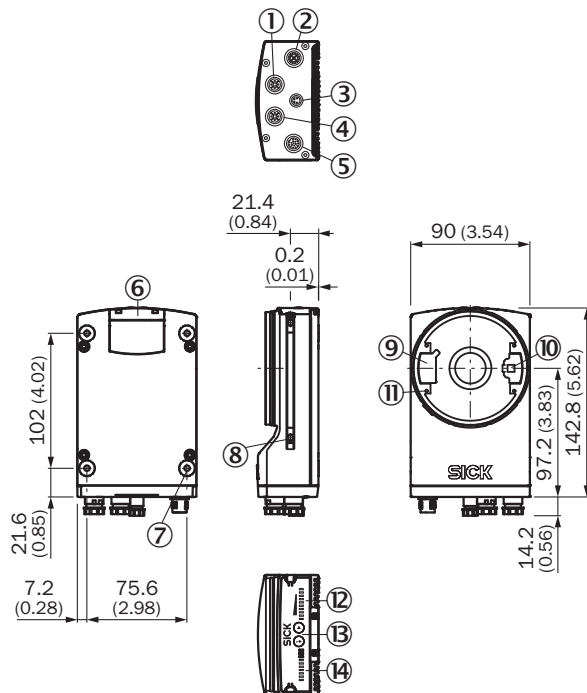

Dimensions in mm (inch)

- ① P1/P2 connection "Ethernet", 100 mBit/s
- ② P3 connection "Ethernet", 1 GBit/s
- ③ X2 "USB" connection or "trigger external lighting", depending on type
- ④ P1/P2 connection "Ethernet", 100 mBit/s
- ⑤ X1 "Power/Serial Data/CAN/I/O" connection or "CAN IN", depending on type
- ⑥ cover for the microSD memory card
- ⑦ M5 blind tapped holes, 5 mm deep (4 x), for mounting the sensor
- ⑧ sliding nut M5, 5.5 mm deep (2 x), for mounting (as alternative)
- ⑨ plug connector for connecting the integrated lighting
- ⑩ laser alignment aid exit
- ⑪ 2.5 mm blind tapped holes (4 x) for mounting the spacers for the integrable illumination
- ⑫ Bar graph display
- ⑬ Function button (2 x)
- ⑭ LED for status display (2 levels), 10 x

Field of view, Lector642 Flex with Panorama 50 mm

Dimensions in mm (inch/*mil)

Max. code size	35 (1.38)	55 (2.17)	70 (2.76)	85 (3.35)	100 (3.94)
Min. resolution 1D-Code	0.11 (*4.2)	0.15 (*6.1)	0.21 (*8.1)	0.26 (*10.1)	0.30 (*12.0)
Min. resolution 2D-Code	0.14 (*5.5)	0.21 (*8.1)	0.27 (*10.8)	0.34 (*13.5)	0.41 (*16.0)

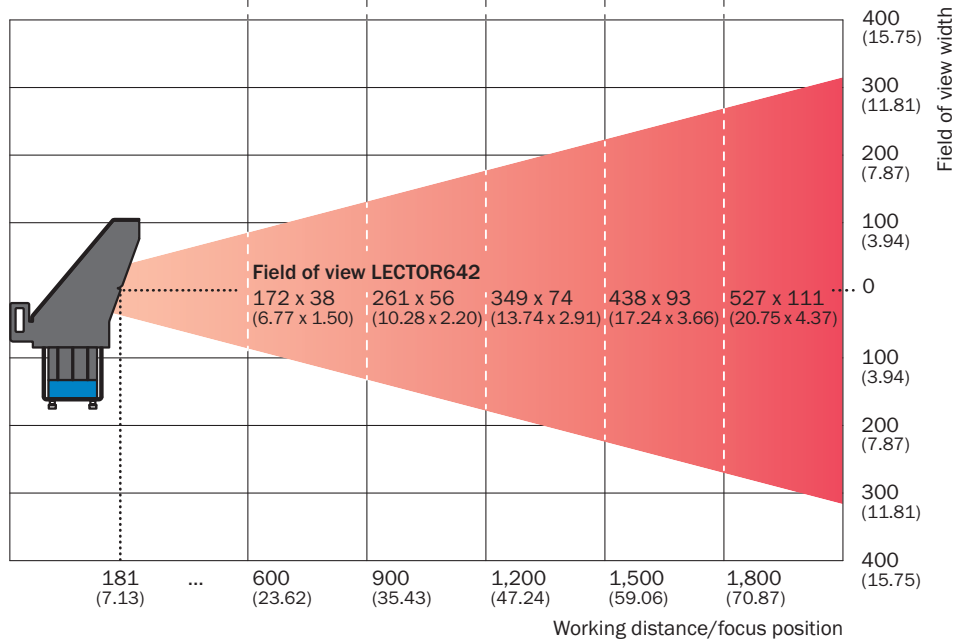

Field of view, Lector642 Flex with Panorama 35 mm/40 mm

Dimensions in mm (inch/*mil)

Max. code size	35 (1.38)	59 (2.32)	77 (3.03)	91 (3.58)	105 (4.13)
Min. resolution 1D-Code	0.11 (*4.2)	0.18 (*7.1)	0.25 (*9.9)	0.33 (*12.8)	0.40 (*15.6)
Min. resolution 2D-Code	0.14 (*5.7)	0.24 (*9.4)	0.34 (*13.2)	0.43 (*17.1)	0.53 (*20.8)

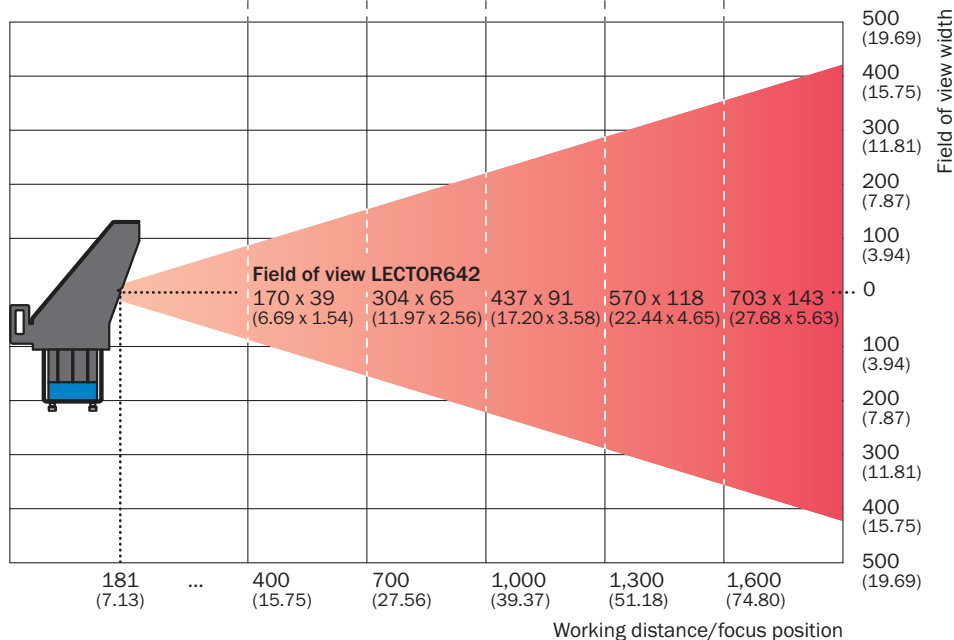

Field of view

Perceived area of field of view: H x V (mm) ①

V2D642R

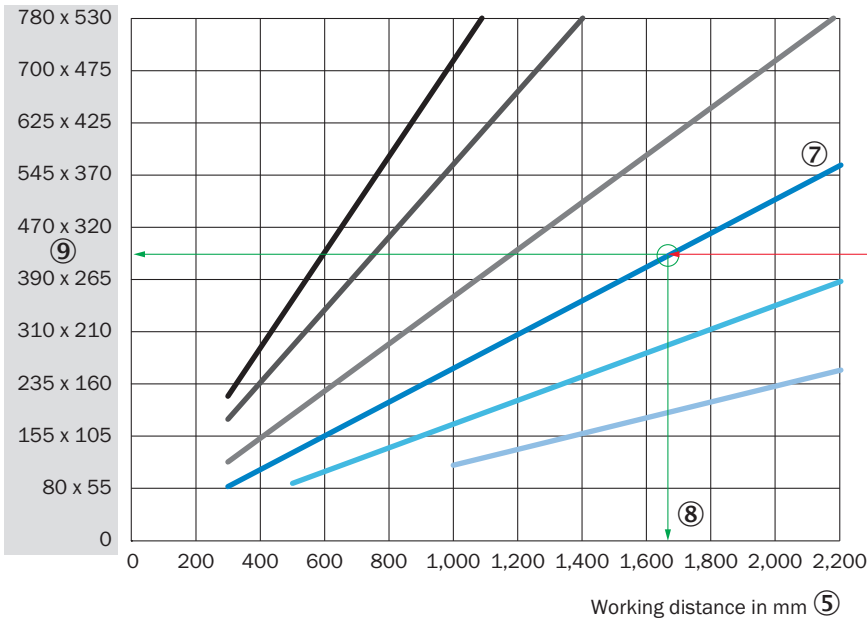

Min. resolution in mm ②

1D code ③

2D code ④

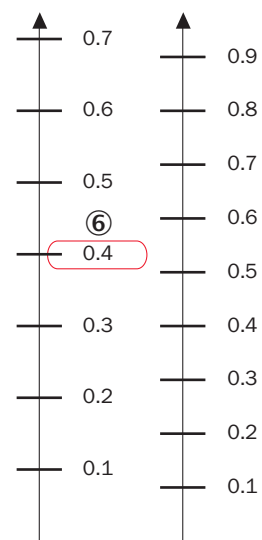

- f = 12 mm — f = 25 mm — f = 50 mm
- f = 16 mm — f = 35 mm — f = 75 mm



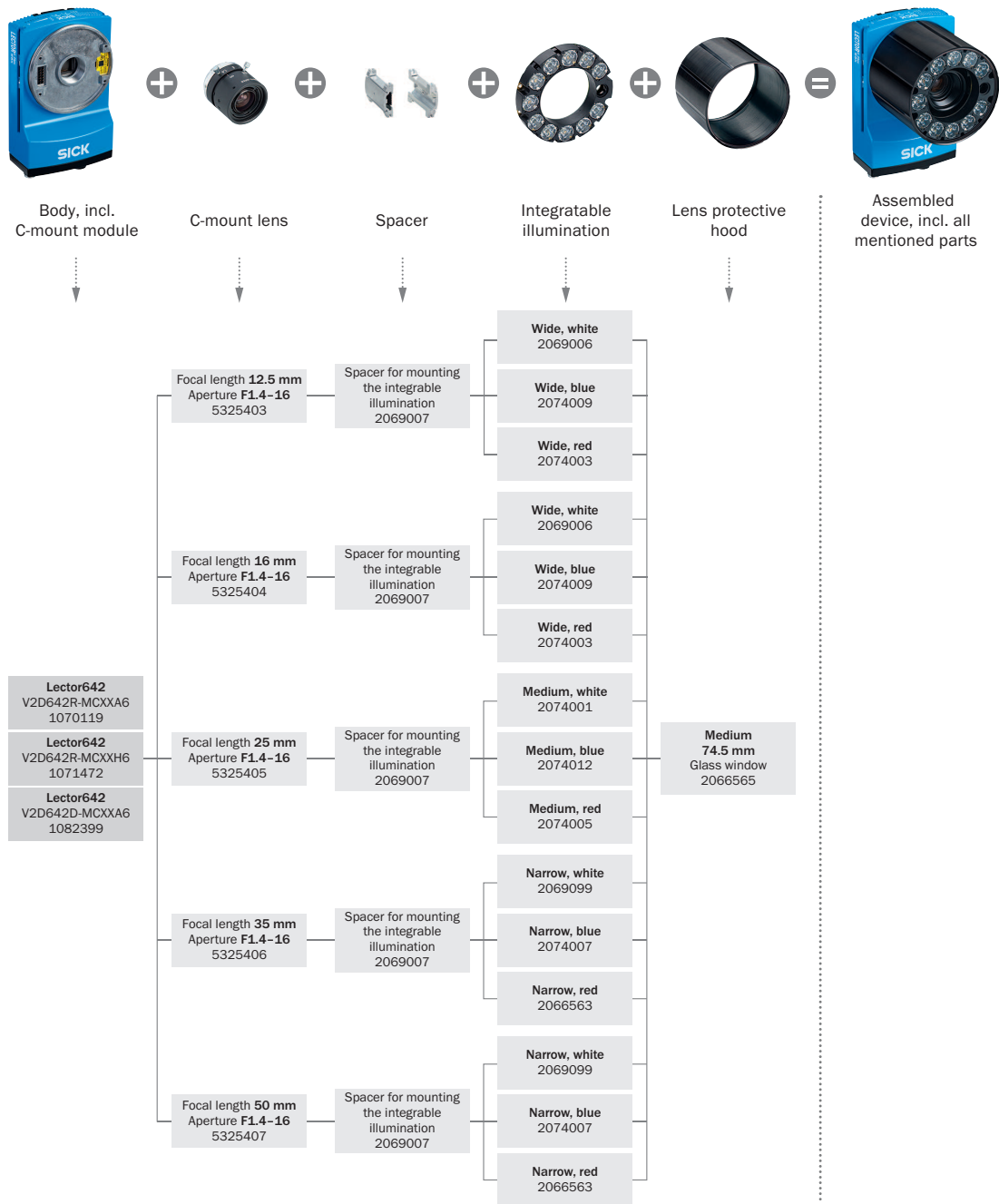

- ① perceived field of view area: horizontal x vertical (mm)
- ② Minimum resolution in mm
- ③ 1D code
- ④ 2D code
- ⑤ Working distance in mm
- ⑥ Selected code resolution
- ⑦ Focal length of lens, here example for f = 35.0 mm
- ⑧ Reading off: resultant maximum working distance
- ⑨ Reading off: Resulting perceived area of the field of view (mm x mm)

Selection Guide



Recommended accessories

Other models and accessories → www.sick.com/Lector64x_Lector65x

	Brief description	Type	part no.
connectors and cables			
	<ul style="list-style-type: none"> • Connection type head A: Male connector, M12, 8-pin, straight, X-coded • Connection type head B: Male connector, RJ45, 8-pin, straight • Signal type: Ethernet, Gigabit Ethernet • Cable: 2 m, 8-wire, PUR, halogen-free • Description: Ethernet, shielded, Gigabit Ethernet • Application: Zones with oils and lubricants 	YM2X18-020EG1M-RJA8	2106258
	<ul style="list-style-type: none"> • Connection type head A: Male connector, M12, 8-pin, straight, X-coded • Connection type head B: Male connector, RJ45, 8-pin, straight • Signal type: Ethernet, Gigabit Ethernet • Cable: 3 m, 8-wire, PUR, halogen-free • Description: Ethernet, shielded, Gigabit Ethernet • Application: Zones with oils and lubricants 	YM2X18-030EG1M-RJA8	2145693
	<ul style="list-style-type: none"> • Description: USB 2.0, shielded • Connection type head A: Male connector, M8, 4-pin, straight • Connection type head B: Male connector, USB-A, 4-pin, straight • Signal type: USB 2.0 • Cable: 2 m, PVC 	YM8U24-020VG3MUSA	6051164
Junction boxes			
		CDB650-204	1064114

	Brief description	Type	part no.
reflectors and optics			
	<ul style="list-style-type: none"> Description: Optics protection hood, enclosure rating IP 65, length: 74.5 mm, glass window 	Protective cover for optics	2066565
	<ul style="list-style-type: none"> Description: Spacer for mounting the integrable illumination, length: 51.3 mm 	Spacer	2069007
	<ul style="list-style-type: none"> Description: Integrable lighting, lighting color white, narrow, suitable for lenses with a focal length of 35 mm, 50 mm and 75 mm 	VI83I-WH2023M0	2069099
	<ul style="list-style-type: none"> Description: Integrable lighting, lighting color white, medium, suitable for lenses with a focal length of 25 mm 	VI83I-WH1441M0	2074001
	<ul style="list-style-type: none"> Description: Integrable lighting, lighting color white, wide, suitable for lenses with a focal length of 12.5 mm and 16 mm 	VI83I-WH0766M0	2069006
	<ul style="list-style-type: none"> Description: Integrable lighting, lighting color blue, wide, suitable for lenses with a focal length of 12.5 mm and 16 mm 	VI83I-BU0766M0	2074009
	<ul style="list-style-type: none"> Description: Integrable lighting, lighting color blue, medium, suitable for lenses with a focal length of 25 mm 	VI83I-BU1441M0	2074012
	<ul style="list-style-type: none"> Description: Integrable lighting, lighting color blue, narrow, suitable for lenses with a focal length of 35 mm, 50 mm and 75 mm 	VI83I-BU2023M0	2074007
	<ul style="list-style-type: none"> Description: C-mount 2/3", focal length 12 mm, aperture 1.4 - 16 Dimensions: 37 mm Without C-mount thread 	C-mount lens	5325403
	<ul style="list-style-type: none"> Description: C-mount lens 1/1.8", focal length 16 mm, aperture 1.4 - 16 Dimensions: 24.1 mm Without C-mount thread 	C-mount lens	5325404
	<ul style="list-style-type: none"> Description: C-mount 1/1.8", focal length 25 mm, aperture 1.4 - 16 Dimensions: 35 mm Without C-mount thread 	C-mount lens	5325405
	<ul style="list-style-type: none"> Description: C-mount 2/3", focal length 35 mm, aperture 1.4 - 16 Dimensions: 36.5 mm Without C-mount thread 	C-mount lens	5325406
	<ul style="list-style-type: none"> Description: C-mount 1/1.8", focal length 50 mm, aperture 1.4 - 16 Dimensions: 62.6 mm Without C-mount thread 	C-mount lens	5325407

SICK AT A GLANCE

SICK is one of the leading manufacturers of intelligent sensors and sensor solutions for industrial applications. A unique range of products and services creates the perfect basis for controlling processes securely and efficiently, protecting individuals from accidents and preventing damage to the environment.

We have extensive experience in a wide range of industries and understand their processes and requirements. With intelligent sensors, we can deliver exactly what our customers need. In application centers in Europe, Asia and North America, system solutions are tested and optimized in accordance with customer specifications. All this makes us a reliable supplier and development partner.

Comprehensive services complete our offering: SICK LifeTime Services provide support throughout the machine life cycle and ensure safety and productivity.

For us, that is “Sensor Intelligence.”

WORLDWIDE PRESENCE:

Contacts and other locations –www.sick.com