



# MZT8-2V8-N-KWA

MZT8 ATEX

CYLINDER SENSORS

**SICK**  
Sensor Intelligence.



### Ordering information

| Type           | part no. |
|----------------|----------|
| MZT8-2V8-N-KWA | 1070456  |

Other models and accessories → [www.sick.com/MZT8\\_ATEX](http://www.sick.com/MZT8_ATEX)



### Detailed technical data

#### Features

|                                    |  |
|------------------------------------|--|
| <b>Cylinder type</b>               | T-slot   |
| <b>Cylinder types with adapter</b> | Profile cylinder<br>Tie rod cylinder<br>Round body cylinder<br>Dovetail groove cylinder<br>SMC rail CDQ2<br>SMC rail ECDQ2 |
| <b>Housing length</b>              | 24 mm  |
| <b>Switching output</b>            | NAMUR  |
| <b>Output characteristic</b>       | Control current depending on switching state according to NAMUR EN 60947-5-6   |
| <b>Switching frequency</b>         | 1,000 Hz   |
| <b>Electrical wiring</b>           | DC 2-wire  |
| <b>Enclosure rating</b>            | IP67 <sup>1)</sup>   |

<sup>1)</sup> According to EN 60529 (IP 67 / IP 68).

#### Mechanics/electronics

|                                   |  |
|-----------------------------------|--|
| <b>Ex area category</b>           | 1G, 1D   |
| <b>Device labeling</b>            | II 1G Ex ia IIC T4 Ga, II 1D Ex ia IIIC T <sub>200</sub> 135 °C Da |
| <b>Response sensitivity, typ.</b> | 2.8 mT   |
| <b>Overrun distance, typ.</b>     | 9 mm   |
| <b>Hysteresis, typ.</b>           | ≤ 0.5 mT   |
| <b>Reproducibility</b>            | ≤ 0.1 mT <sup>1)</sup>   |

<sup>1)</sup> Supply voltage  $U_B$  and constant ambient temperature  $T_a$ .

<sup>2)</sup> PVC-cable without UL-Certificate.

<sup>3)</sup> For connection to a separately certified intrinsically safe circuit only.

|  |   |
|--|---|
| <b>Reverse polarity protection</b>             | Yes   |
| <b>Short-circuit protection</b>                | Yes   |
| <b>Status indicator LED</b>                    | Yes   |
| <b>Teach-in</b>                                | No  |
| <b>Power-up pulse protection</b>               | Yes   |
| <b>Ambient operating temperature</b>           | -25 °C ... +80 °C   |
| <b>Shock and vibration resistance</b>          | 30 g, 11 ms / 10 ... 55 Hz, 1 mm  |
| <b>EMC</b>                                     | According to EN 60947-5-2   |
| <b>Connection type</b>                         | Cable, 2-wire, ferrules, 3 m  |
| <b>Connection type Detail</b>                  |   |
| Conductor cross section                        | 0.12 mm <sup>2</sup>  |
| Cable diameter                                 | Ø 2.9 mm  |
| Bending radius                                 | With fixed installation > 3 x cable diameter<br>For flexible use > 5 x cable diameter |
| Cable outlet                                   | Axial   |
| <b>Material</b>                                |   |
| Housing  | Plastic, PA12   |
| Cable  | PVC <sup>2)</sup>   |
| <b>EC-Type examination certificate</b>         | TÜV 14 ATEX 143125  |
| <b>UK type examination certificate</b>         | UL22UKEX2384  |
| <b>Certificate (IECEX)</b>                     | IECEX TUN 14.0038   |
| <b>Input voltage U<sub>i</sub> max.</b>        | 20 V <sup>3)</sup>  |
| <b>Input power P<sub>i</sub> max.</b>          | 100 mW <sup>3)</sup>  |
| <b>Input current I<sub>i</sub> max.</b>        | 60 mA <sup>3)</sup>   |
| <b>Internal capacitance C<sub>i</sub> max.</b> | 130 nF <sup>3)</sup>  |
| <b>Internal inductance L<sub>i</sub> max.</b>  | 30 µH <sup>3)</sup>   |
| <b>Nominal voltage</b>                         | 8.2 V DC  |

<sup>1)</sup> Supply voltage U<sub>B</sub> and constant ambient temperature T<sub>a</sub>.

<sup>2)</sup> PVC-cable without UL-Certificate.

<sup>3)</sup> For connection to a separately certified intrinsically safe circuit only.

### Safety-related parameters

|                                     |             |
|-------------------------------------|-------------|
| <b>MTTF<sub>D</sub></b>             | 2,874 years |
| <b>DC<sub>avg</sub></b>             | 0 %         |
| <b>T<sub>M</sub> (mission time)</b> | 20 years    |

### Certificates

|   |   |
|---|---|
| <b>EU declaration of conformity</b>       | ✓ |
| <b>UK declaration of conformity</b>       | ✓ |
| <b>ACMA declaration of conformity</b>     | ✓ |
| <b>Moroccan declaration of conformity</b> | ✓ |
| <b>China RoHS</b>                         | ✓ |

|                          |   |
|--------------------------|---|
| <b>ATEX certificate</b>  | ✓ |
| <b>IECEX certificate</b> | ✓ |

### Classifications

|                       |          |
|-----------------------|----------|
| <b>ECLASS 5.0</b>     | 27270104 |
| <b>ECLASS 5.1.4</b>   | 27270104 |
| <b>ECLASS 6.0</b>     | 27270104 |
| <b>ECLASS 6.2</b>     | 27270104 |
| <b>ECLASS 7.0</b>     | 27270104 |
| <b>ECLASS 8.0</b>     | 27270104 |
| <b>ECLASS 8.1</b>     | 27270104 |
| <b>ECLASS 9.0</b>     | 27270104 |
| <b>ECLASS 10.0</b>    | 27270104 |
| <b>ECLASS 11.0</b>    | 27270104 |
| <b>ECLASS 12.0</b>    | 27274301 |
| <b>ETIM 5.0</b>       | EC002544 |
| <b>ETIM 6.0</b>       | EC002544 |
| <b>ETIM 7.0</b>       | EC002544 |
| <b>ETIM 8.0</b>       | EC002544 |
| <b>UNSPSC 16.0901</b> | 39122230 |

### Installation note

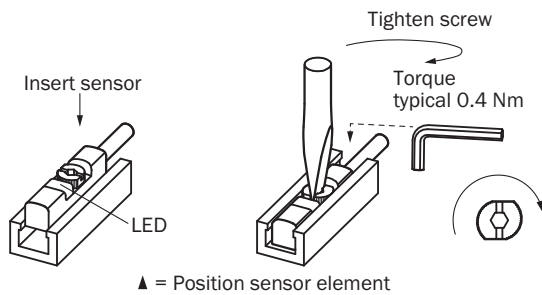

### Connection diagram Cd-304

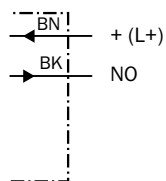

Connection diagram Cd-305

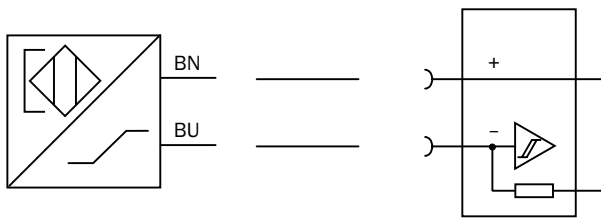

Dimensional drawing Cable

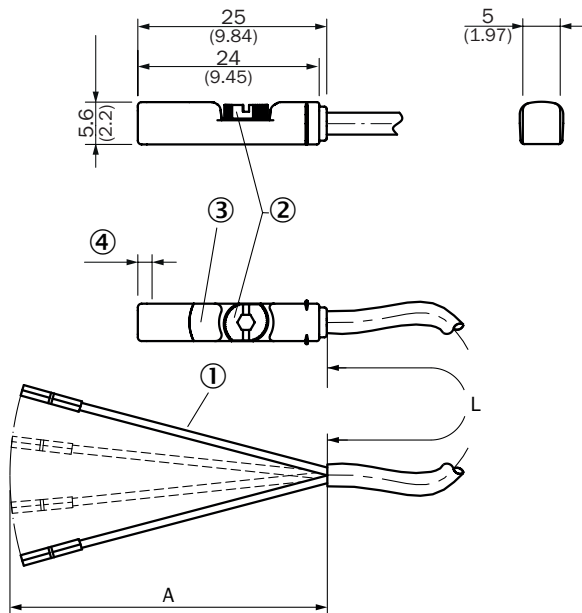

Dimensions in mm (inch)









- ① Connection
- ② Fixing screw SW 2.0
- ③ Display LED
- ④ sensor element position = long overrun distance (9 mm): 1.6 mm

| Part no. | Type              | L   | A     | Number of cores |
|----------|-------------------|-----|-------|-----------------|
| 1069424  | MZT8-2V8-N-KW0    | 2 m | 42 mm | 2               |
| 1070456  | MZT8-2V8-N-KWA    | 3 m | 42 mm | 2               |
| 1070461  | MZT8-2V8-N-KWB    | 5 m | 42 mm | 2               |
| 1070462  | MZT8-2V8-N-KWDS01 | 6 m | 42 mm | 2               |
| 1070463  | MZT8-2V8-N-KWDS02 | 7 m | 42 mm | 2               |
| 1070464  | MZT8-2V8-N-KWDS03 | 7 m | 42 mm | 2               |

Recommended accessories

Other models and accessories → [www.sick.com/MZT8\\_ATEX](http://www.sick.com/MZT8_ATEX)

|   | Brief description  | Type            | part no. |
|---|--|-----------------|----------|
| Mounting systems  |  |                 |          |
|    | <ul style="list-style-type: none"> <li>• <b>Description:</b> Mounting bracket for integrated profile cylinder/tie-rod cylinder</li> <li>• <b>Material:</b> Zinc diecast</li> <li>• <b>Details:</b> Zinc diecast</li> <li>• <b>Items supplied:</b> Mounting hardware included</li> </ul>  | BEF-KHZ-PT1     | 2022702  |
|    | <ul style="list-style-type: none"> <li>• <b>Description:</b> Mounting bracket for cylinder with dovetail slot</li> <li>• <b>Material:</b> Aluminum</li> <li>• <b>Details:</b> Aluminum</li> <li>• <b>Items supplied:</b> Without mounting hardware</li> </ul>  | BEF-KHZ-ST1     | 2022703  |
|    | <ul style="list-style-type: none"> <li>• <b>Description:</b> Mounting bracket for mounting on SMC rails ECDQ2 (T-slot)</li> <li>• <b>Material:</b> Aluminum</li> <li>• <b>Details:</b> Aluminum</li> <li>• <b>Items supplied:</b> Without mounting hardware</li> </ul>   | BEF-KHZ-TT1     | 2046439  |
|    | <ul style="list-style-type: none"> <li>• <b>Description:</b> Mounting bracket for mounting on SMC rails CDQ2 (T-slot)</li> <li>• <b>Material:</b> Aluminum</li> <li>• <b>Details:</b> Aluminum</li> <li>• <b>Items supplied:</b> Without mounting hardware</li> </ul>  | BEF-KHZ-TT2     | 2046440  |
|    | <ul style="list-style-type: none"> <li>• <b>Description:</b> Mounting bracket on round body cylinder with piston diameter of 8 mm ... 130 mm, ambient temperature min -30 °C max 80 °C</li> <li>• <b>Material:</b> Stainless steel, Zinc cast</li> <li>• <b>Details:</b> Stainless steel, Zinc cast</li> <li>• <b>Packing unit:</b> 1 piece</li> <li>• <b>Suitable for:</b> T-slot</li> </ul>                    | BEF-KHZ-RT1-130 | 2077684  |
|  | <ul style="list-style-type: none"> <li>• <b>Description:</b> Mounting bracket on round body cylinder with piston diameter of 12 mm, ambient temperature min 0 °C max 50 °C</li> <li>• <b>Dimensions (W x H x L):</b> 22.4 m</li> <li>• <b>Material:</b> Plastic, Aluminum</li> <li>• <b>Details:</b> Plastic, Aluminum</li> <li>• <b>Packing unit:</b> 1 piece</li> <li>• <b>Suitable for:</b> T-slot</li> </ul> | BEF-KHZ-RT-12   | 2077681  |
|  | <ul style="list-style-type: none"> <li>• <b>Description:</b> Mounting bracket on round body cylinder with piston diameter of 8 mm ... 25 mm, ambient temperature min -30 °C max 80 °C</li> <li>• <b>Material:</b> Stainless steel, Zinc cast</li> <li>• <b>Details:</b> Stainless steel, Zinc cast</li> <li>• <b>Packing unit:</b> 1 piece</li> <li>• <b>Suitable for:</b> T-slot</li> </ul>                     | BEF-KHZ-RT1-25  | 2077682  |
|  | <ul style="list-style-type: none"> <li>• <b>Description:</b> Mounting bracket on round body cylinder with piston diameter of 16 mm, ambient temperature min 0 °C max 50 °C</li> <li>• <b>Dimensions (W x H x L):</b> 26.6 m</li> <li>• <b>Material:</b> Plastic, Aluminum</li> <li>• <b>Details:</b> Plastic, Aluminum</li> <li>• <b>Packing unit:</b> 1 piece</li> <li>• <b>Suitable for:</b> T-slot</li> </ul> | BEF-KHZ-RT-16   | 2077680  |
|  | <ul style="list-style-type: none"> <li>• <b>Description:</b> Mounting bracket on round body cylinder with piston diameter of 8 mm ... 63 mm, ambient temperature min -30 °C max 80 °C</li> <li>• <b>Material:</b> Stainless steel, Zinc cast</li> <li>• <b>Details:</b> Stainless steel, Zinc cast</li> <li>• <b>Packing unit:</b> 1 piece</li> <li>• <b>Suitable for:</b> T-slot</li> </ul>                     | BEF-KHZ-RT1-63  | 2077683  |
|  | <ul style="list-style-type: none"> <li>• <b>Description:</b> Mounting bracket on round body cylinder with piston diameter of 20 mm, ambient temperature min 0 °C max 50 °C</li> <li>• <b>Dimensions (W x H x L):</b> 30.6 m</li> <li>• <b>Material:</b> Plastic, Aluminum</li> <li>• <b>Details:</b> Plastic, Aluminum</li> <li>• <b>Packing unit:</b> 1 piece</li> </ul>  | BEF-KHZ-RT-20   | 2077679  |

|   | Brief description   | Type          | part no. |
|---|---|---------------|----------|
|    | <ul style="list-style-type: none"> <li>• <b>Suitable for:</b> T-slot</li> <li>• <b>Description:</b> Mounting bracket on round body cylinder with piston diameter of 25 mm, ambient temperature min 0 °C max 50 °C</li> <li>• <b>Dimensions (W x H x L):</b> 35.7 m</li> <li>• <b>Material:</b> Plastic, Aluminum</li> <li>• <b>Details:</b> Plastic, Aluminum</li> <li>• <b>Packing unit:</b> 1 piece</li> <li>• <b>Suitable for:</b> T-slot</li> </ul> | BEF-KHZ-RT-25 | 2077678  |
|    | <ul style="list-style-type: none"> <li>• <b>Description:</b> Mounting bracket on round body cylinder with piston diameter of 32 mm, ambient temperature min 0 °C max 50 °C</li> <li>• <b>Dimensions (W x H x L):</b> 42.9 m</li> <li>• <b>Material:</b> Plastic, Aluminum</li> <li>• <b>Details:</b> Plastic, Aluminum</li> <li>• <b>Packing unit:</b> 1 piece</li> <li>• <b>Suitable for:</b> T-slot</li> </ul>  | BEF-KHZ-RT-32 | 2077677  |
|    | <ul style="list-style-type: none"> <li>• <b>Description:</b> Mounting bracket on round body cylinder with piston diameter of 40 mm, ambient temperature min 0 °C max 50 °C</li> <li>• <b>Dimensions (W x H x L):</b> 50.9 m</li> <li>• <b>Material:</b> Plastic, Aluminum</li> <li>• <b>Details:</b> Plastic, Aluminum</li> <li>• <b>Packing unit:</b> 1 piece</li> <li>• <b>Suitable for:</b> T-slot</li> </ul>  | BEF-KHZ-RT-40 | 2077676  |
|    | <ul style="list-style-type: none"> <li>• <b>Description:</b> Mounting bracket on round body cylinder with piston diameter of 50 mm, ambient temperature min 0 °C max 50 °C</li> <li>• <b>Dimensions (W x H x L):</b> 61.8 m</li> <li>• <b>Material:</b> Plastic, Aluminum</li> <li>• <b>Details:</b> Plastic, Aluminum</li> <li>• <b>Packing unit:</b> 1 piece</li> <li>• <b>Suitable for:</b> T-slot</li> </ul>  | BEF-KHZ-RT-50 | 2077675  |
|   | <ul style="list-style-type: none"> <li>• <b>Description:</b> Mounting bracket on round body cylinder with piston diameter of 63 mm, ambient temperature min 0 °C max 50 °C</li> <li>• <b>Dimensions (W x H x L):</b> 73.9 m</li> <li>• <b>Material:</b> Plastic, Aluminum</li> <li>• <b>Details:</b> Plastic, Aluminum</li> <li>• <b>Packing unit:</b> 1 piece</li> <li>• <b>Suitable for:</b> T-slot</li> </ul>  | BEF-KHZ-RT-63 | 2077674  |
| device protection and care  |   |               |          |
|  | <ul style="list-style-type: none"> <li>• <b>Description:</b> Protective adapter</li> <li>• <b>Material:</b> Zinc diecast</li> <li>• <b>Items supplied:</b> Mounting hardware included</li> <li>• <b>Suitable for:</b> MZT7, RZT7, MZT8</li> </ul>   | BEF-SG-MRZT   | 2077201  |
| integration modules and adapters  |   |               |          |
|  | <ul style="list-style-type: none"> <li>• <b>Description:</b> NAMUR isolating amplifier, Cable fault detection, Switching outputs: 2 NO relay (1 per channel), Supply voltage: 24 V ... 230 V, Voltage type: AC/DC</li> </ul>  | EN2-2EX1      | 6041096  |
|  | <ul style="list-style-type: none"> <li>• <b>Description:</b> NAMUR isolating amplifier, Cable fault detection, Switching outputs: 2 NO relay (1 per channel), Supply voltage: 19,2 V ... 30 V, Voltage type: DC</li> </ul>  | EN2-2EX3      | 6041095  |

## SICK AT A GLANCE

SICK is one of the leading manufacturers of intelligent sensors and sensor solutions for industrial applications. A unique range of products and services creates the perfect basis for controlling processes securely and efficiently, protecting individuals from accidents and preventing damage to the environment.

We have extensive experience in a wide range of industries and understand their processes and requirements. With intelligent sensors, we can deliver exactly what our customers need. In application centers in Europe, Asia and North America, system solutions are tested and optimized in accordance with customer specifications. All this makes us a reliable supplier and development partner.

Comprehensive services complete our offering: SICK LifeTime Services provide support throughout the machine life cycle and ensure safety and productivity.

For us, that is “Sensor Intelligence.”

## WORLDWIDE PRESENCE:

Contacts and other locations –[www.sick.com](http://www.sick.com)