



LMS111-10100S09

LMS1xx

2D LIDAR SENSORS

SICK
Sensor Intelligence.



Ordering information

Type	part no.
LMS111-10100S09	1068858

Other models and accessories → www.sick.com/LMS1xx



Detailed technical data

Features

Application	Outdoor, Indoor
Light source	Infrared (905 nm)
Laser class	1 (IEC 60825-1:2014, EN 60825-1:2014+A11:2021)
Aperture angle	Horizontal 270°
Scanning frequency	25 Hz 50 Hz
Angular resolution	Horizontal 0.25° 0.5°
Heating	Yes
Working range	0.5 m ... 20 m
Scanning range	At 10% remission factor 18 m At 90% remission factor 20 m
Amount of evaluated echoes	2
Fog correction	Yes

Mechanics/electronics

Connection type	1 x M12 round connector
Supply voltage	10.8 V DC ... 30 V DC
Power consumption	Typ. 8 W, heating typ. 35 W
Housing color	Gray (RAL 7032)
Enclosure rating	IP67 (EN 60529, Section 14.2.7)
Protection class	III (EN 61010-1:2010-10)
Weight	1.1 kg
Dimensions (L x W x H)	105 mm x 102 mm x 162 mm

MTBF	> 100 years
MTTFd	> 100 years

Safety-related parameters

MTTF_D	> 100 years
-------------------------	-------------

Performance

Response time	≥ 20 ms
Detectable object shape	Almost any
Systematic error	± 30 mm ¹⁾
Statistical error	12 mm ¹⁾
Integrated application	Field evaluation Easy teach option
Number of field sets	10 fields
Simultaneous evaluation cases	10

¹⁾ Typical value; actual value depends on environmental conditions.

Interfaces

Ethernet		✓, TCP/IP
	Function	Data interface (read result output)
	Data transmission rate	10/100 MBit/s
Serial		✓, RS-232
	Function	Data interface (read result output), Service interface
	Data transmission rate	9.6 kBaud ... 115.2 kBaud
CAN		✓
	Function	Extension of outputs
Digital inputs/outputs		
	Inputs	2 digital and 2 encoder inputs
	Outputs	3
Optical indicators		7-segment display (plus 5 LEDs showing device status, contamination warning and initial condition)

Ambient data

Remission factor	3 % ... > 1,000 % (reflectors)
Electromagnetic compatibility (EMC)	EN 61000-6-2:2005 / EN 61000-6-3:2007+A1:2011
Vibration resistance	EN 60068-2-6 (1995-04)
Shock resistance	EN 60068-2-27 (1993-03)
Ambient operating temperature	-30 °C ... +50 °C
Storage temperature	-30 °C ... +70 °C
Ambient light immunity	80,000 lx

General notes

Note on use	The sensor does not constitute a safety component as defined by relevant legislation on machine safety.
--------------------	---

Certificates

EU declaration of conformity	✓
-------------------------------------	---

UK declaration of conformity	✓
ACMA declaration of conformity	✓
China RoHS	✓
cTUVus certificate	✓
Information according to Art. 3 of Data Act (Regulation EU 2023/2854)	✓

Classifications

ECLASS 5.0	27270990
ECLASS 5.1.4	27270990
ECLASS 6.0	27270913
ECLASS 6.2	27270913
ECLASS 7.0	27270913
ECLASS 8.0	27270913
ECLASS 8.1	27270913
ECLASS 9.0	27270913
ECLASS 10.0	27270913
ECLASS 11.0	27270913
ECLASS 12.0	27270913
ETIM 5.0	EC002550
ETIM 6.0	EC002550
ETIM 7.0	EC002550
ETIM 8.0	EC002550
UNSPSC 16.0901	41111615

Dimensional drawing

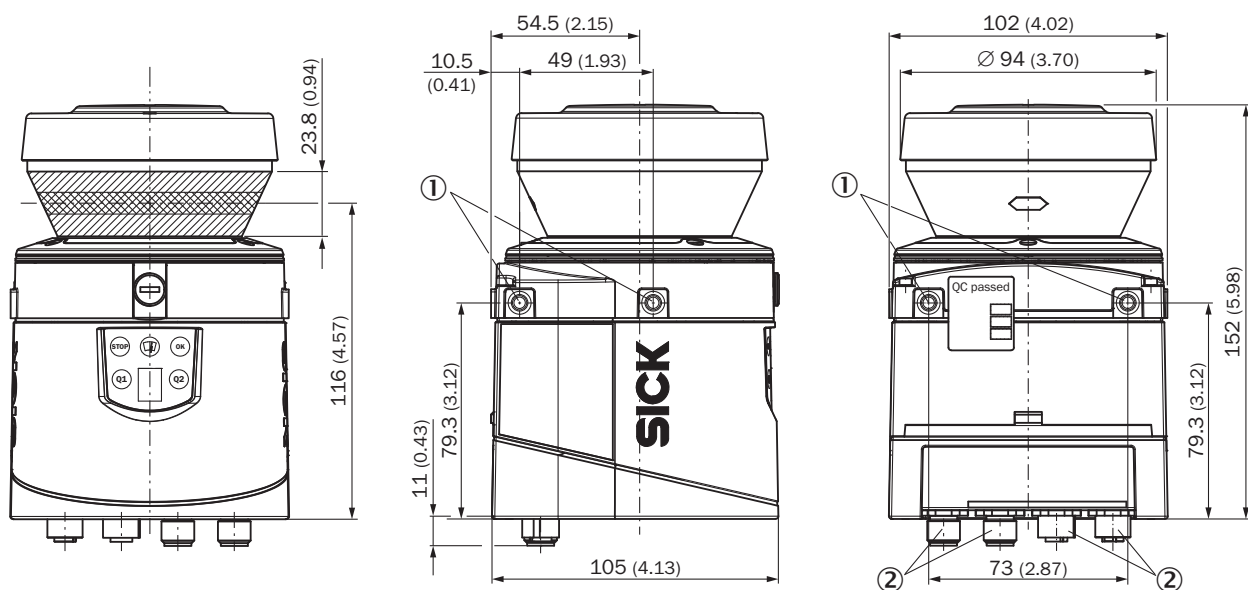

Dimensions in mm (inch)

- ① Mounting hole M5 x 7.5
- ② Connector M12

Working range diagram

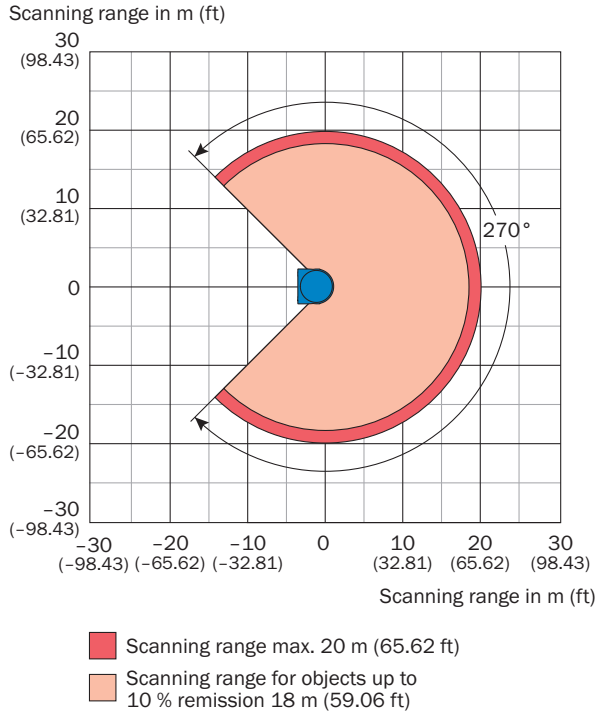

Connection type Ethernet

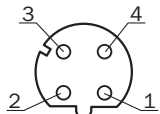

M12 female connector, 4-pin, D-coded

- ① TX+
- ② RX+
- ③ TX-
- ④ RX-

PIN assignment “data” connection

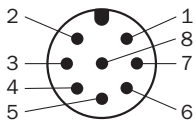

M12 male connector, 8-pin, A-coded

- ① RxD (HOST)
- ② TxD (HOST)
- ③ CAN_HI

- ④ CAN_LO
- ⑤ GND RS/CAN
- ⑥ In₁
- ⑦ In₂
- ⑧ GND IN1/2

PIN assignment I/O connection

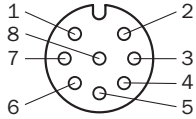

female connector M12, 8-pin, A-coded

- ① LMS11x: INC1 A / LMS15x/LMS16x: INC1 A or IN4 (switchable, pins 1 and 2 must be switched together)
- ② LMS11x: INC1 B / LMS15x/LMS16x: INC1 B or IN3 (switchable, pins 1 and 2 must be switched together)
- ③ GND INC1
- ④ OUT1 A
- ⑤ OUT2 A
- ⑥ OUT3 A
- ⑦ OUT1 ... 3 B
- ⑧ OUT1 ... 3 R

PIN assignment Power

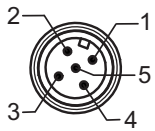

Connector M12, 5-pin, A-coded

- ① V_s
- ② V_s heat.
- ③ GND
- ④ Reserved
- ⑤ GND heat.

PIN assignment Service interface

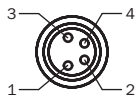







female connector M8, 4-pin

- ① Reserved
- ② RxD AUX
- ③ GND RS
- ④ TxD AUX

Recommended accessories

Other models and accessories → www.sick.com/LMS1xx

	Brief description	Type	part no.
Mounting systems			
	<ul style="list-style-type: none"> Description: Mounting bracket for rear mounting on wall or machine Material: Anodized aluminum Details: AlMg3, black anodized Packing unit: 1 piece Items supplied: Mounting bracket, 4 x M5 x 10 countersunk screws 	Mounting kit 1a	2034324
	<ul style="list-style-type: none"> Description: Mounting bracket for rear mounting on wall or machine with protection of optics hood Material: Anodized aluminum Details: AlMg3, black anodized Packing unit: 1 piece Items supplied: Mounting bracket, 4 x M5 x 10 countersunk screws 	Mounting kit 1b	2034325
	<ul style="list-style-type: none"> Description: Mounting bracket, adjustable lateral axis, only in conjunction with mounting kit 1a (2034324) or 1b (2034325) Material: Anodized aluminum Details: AlMg3, black anodized Packing unit: 1 piece Items supplied: Mounting bracket, 4 x countersunk screws with washers M4 x 10, 4 x spring washer 	Mounting kit 2	2039302
	<ul style="list-style-type: none"> Description: Mounting plate, adjustable longitudinal axis, only in conjunction with mounting kit 2 (2039302) Material: Anodized aluminum Details: AlMg3, black anodized Packing unit: 1 piece Items supplied: Mounting plate, 2 x countersunk screws with washers M4 x 10, 2 x spring washer 	Mounting kit 3	2039303
	<ul style="list-style-type: none"> Description: Standard mounting set for weather hood Material: Stainless steel 1.4301 (V2A) Details: Stainless steel 1.4301 (V2A) Items supplied: Mounting bracket, incl. 7 x screws with M6 x 12 washers Suitable for: 2085937, 2085938, 2085939, 2046459, 2046458, 2082563, 2082560 	Mounting bracket	2046025
	<ul style="list-style-type: none"> Description: Quick-action lock system for weather hood Material: Steel, Aluminum Details: Clamping piece: steel (X5CRNI1810), Clamping profile: aluminum (ALMGSI0) Suitable for: 2085937, 2085938, 2085939, 2046459, 2046458, 2082563, 2082560 	Quick release	2046989

	Brief description	Type	part no.
connectors and cables			
	<ul style="list-style-type: none"> • Connection type head A: Male connector, M12, 4-pin, straight, D-coded • Connection type head B: Male connector, RJ45, 4-pin, straight • Signal type: Ethernet, PROFINET • Cable: 5 m, 4-wire, PUR, halogen-free • Description: Ethernet, shielded, PROFINET • Application: Drag chain operation, Zones with oils and lubricants 	YM2D24-050P-N1MRJA4	2106184
	<ul style="list-style-type: none"> • Connection type head A: Female connector, M12, 5-pin, straight, A-coded • Connection type head B: Flying leads • Signal type: Power • Cable: 5 m, 4-wire, PUR, halogen-free • Description: Power, shielded • Connection systems: Flying leads 	YF2A64-050XXXXLEAX	6036159
	<ul style="list-style-type: none"> • Description: Sensor/actuator cable, shielded • Connection type head A: Female connector, M12, 8-pin, straight, A-coded • Connection type head B: Flying leads • Signal type: Sensor/actuator cable • Cable: 5 m, 8-wire, PUR, halogen-free • Application: Drag chain operation, Zones with oils and lubricants, Robot, Drag chain operation 	YF2A28-050UA6XLEAX	2095835
	<ul style="list-style-type: none"> • Description: Sensor/actuator cable, shielded • Connection type head A: Female connector, M12, 8-pin, straight, A-coded • Connection type head B: Flying leads • Signal type: Sensor/actuator cable • Cable: 0.6 m, 8-wire, PUR, halogen-free • Application: Drag chain operation, Zones with oils and lubricants, Robot, Drag chain operation 	YF2A28-C60UA6XLEAX	2145470
	<ul style="list-style-type: none"> • Description: Sensor/actuator cable, shielded • Connection type head A: Female connector, M12, 8-pin, straight, A-coded • Connection type head B: Flying leads • Signal type: Sensor/actuator cable • Cable: 1 m, 8-wire, PUR, halogen-free • Application: Drag chain operation, Zones with oils and lubricants, Robot, Drag chain operation 	YF2A28-010UA6XLEAX	2145471
	<ul style="list-style-type: none"> • Description: Sensor/actuator cable, shielded • Connection type head A: Female connector, M12, 8-pin, straight, A-coded • Connection type head B: Flying leads • Signal type: Sensor/actuator cable • Cable: 2 m, 8-wire, PUR, halogen-free • Application: Drag chain operation, Zones with oils and lubricants, Robot, Drag chain operation 	YF2A28-020UA6XLEAX	2145472
	<ul style="list-style-type: none"> • Description: Sensor/actuator cable, shielded • Connection type head A: Female connector, M12, 8-pin, straight, A-coded • Connection type head B: Flying leads • Signal type: Sensor/actuator cable • Cable: 3 m, 8-wire, PUR, halogen-free • Application: Drag chain operation, Zones with oils and lubricants, Robot, Drag chain operation 	YF2A28-030UA6XLEAX	2145473
device protection and care			
	<ul style="list-style-type: none"> • Description: Weather hood, 190° • Material: Aluminum • Items supplied: Weather hood, 190°, 3 x M5 x 12 screws • Suitable for: LMS10x, LMS11x, LMS12x, LMS13x, LMS14x, LMS15x, S100 	Weather protection cover 190°	2046459
	<ul style="list-style-type: none"> • Description: Weather protection hood 270° • Material: Aluminum • Items supplied: Weather hood, 270°, 3 x M5 x 12 screws • Suitable for: LMS10x, LMS11x, LMS12x, LMS13x, LMS14x, LMS15x, S100 	Weather protection cover 270°	2046458

SICK AT A GLANCE

SICK is one of the leading manufacturers of intelligent sensors and sensor solutions for industrial applications. A unique range of products and services creates the perfect basis for controlling processes securely and efficiently, protecting individuals from accidents and preventing damage to the environment.

We have extensive experience in a wide range of industries and understand their processes and requirements. With intelligent sensors, we can deliver exactly what our customers need. In application centers in Europe, Asia and North America, system solutions are tested and optimized in accordance with customer specifications. All this makes us a reliable supplier and development partner.

Comprehensive services complete our offering: SICK LifeTime Services provide support throughout the machine life cycle and ensure safety and productivity.

For us, that is “Sensor Intelligence.”

WORLDWIDE PRESENCE:

Contacts and other locations –www.sick.com