



OPR20G-RB417537

Glare

GLARE SENSORS

SICK
Sensor Intelligence.



Ordering information

Type	part no.
OPR20G-RB417537	1068823

Other models and accessories → www.sick.com/Glare

Illustration may differ



Detailed technical data

Features

Sensor principle	Delta-S-Technology®
Housing design	Middle
Dimensions (W x H x D)	42.5 mm x 44 mm x 43.4 mm
Light source	LED, visible red light ¹⁾
Light spot size	10 mm x 12 mm
Wave length	640 nm
Sensing distance	≤ 50 mm
Sensing distance tolerance	± 5 mm
Tilt angle tolerance	± 5°
Minimum detectable object (MDO)	12 x 14 mm
Sensitivity	Fine, middle, coarse
Object speed max.	2 m/s ²⁾
Adjustment	Potentiometer, cable, IO-Link, Single teach-in button (Sensitivity (Q, Q/, teach-in), Teach-in / Keylock, Teach-in) ^{3) 4)}
Teach-in mode	Static 1-point teach-in Static 2-point teach-in Dynamic 2-point teach-in Static 3-point teach-in

¹⁾ Average service life: 100,000 h at T_U = +25 °C.

²⁾ Minimum object size.

³⁾ HIGH = > V_S - 2 V / LOW = open or < 2 V.

⁴⁾ Default: keylock.

Interfaces

IO-Link	✓
VendorID	26
DeviceID HEX	800058
DeviceID DEC	8388696
Cycle time	2.3 ms
Process data structure	Bit 0 = switching signal Q _{L1} Bit 1 = switching signal Q _{L2} Bit 2 = Quality of Run Alarm Bit 3 = Teach successful Bit 4 = Teach busy Bit 5 ... 15 = empty

Electronics

Supply voltage	10 V DC ... 30 V DC ¹⁾
Ripple	≤ 5 V _{pp} ²⁾
Current consumption	< 150 mA ³⁾
Switching frequency	500 Hz ⁴⁾
Response time	1 ms
Jitter	500 μs
Number of switching outputs	2 (Q ₁ , Q ₂)
Switching output	Push-pull: PNP/NPN
Switching output (voltage)	Push-pull: PNP/NPN (High: V _S - 3 V, Low: < 3 V)
Output current I_{max}	< 100 mA ⁵⁾
Initialization time	< 2.5 s
Switch-on delay	0 s ... 30 s
Off delay	0 s ... 30 s
Pulse duration	≤ 30 s
Protection class	III
Circuit protection	A ⁶⁾ C ⁷⁾ D ⁸⁾
Connection type	Plug, M12, 5-pin

¹⁾ Limit values when operated in short-circuit protected network: max. 8 A.

²⁾ May not fall below or exceed U_y tolerances.

³⁾ Without load.

⁴⁾ With light/dark ratio 1:1.

⁵⁾ Consumption count Q₁ / Q₂.

⁶⁾ A = V_S connections reverse-polarity protected.

⁷⁾ C = interference suppression.

⁸⁾ D = outputs overcurrent and short-circuit protected.

Mechanics

Housing material	ABS
Weight	130 g

Ambient data

Ambient operating temperature	-10 °C ... +55 °C
Ambient temperature, storage	-25 °C ... +75 °C
Ambient light immunity	> 50 klx
Shock load	According to EN 60068-2-27, single shock (30 g/11 MS), continuous shock (25 g/11 MS)
Enclosure rating	IP67
UL File No.	NRKH.E181493

Certificates

EU declaration of conformity	✓
UK declaration of conformity	✓
ACMA declaration of conformity	✓
Moroccan declaration of conformity	✓
China RoHS	✓
cULus certificate	✓
IO-Link certificate	✓
Photobiological safety (IEC EN 62471)	✓
Information according to Art. 3 of Data Act (Regulation EU 2023/2854)	✓

Classifications

ECLASS 5.0	27270906
ECLASS 5.1.4	27270906
ECLASS 6.0	27270906
ECLASS 6.2	27270906
ECLASS 7.0	27270906
ECLASS 8.0	27270906
ECLASS 8.1	27270906
ECLASS 9.0	27270906
ECLASS 10.0	27270906
ECLASS 11.0	27270906
ECLASS 12.0	27270906
ETIM 5.0	EC001820
ETIM 6.0	EC001820
ETIM 7.0	EC001820
ETIM 8.0	EC001820
UNSPSC 16.0901	39121528

Dimensional drawing

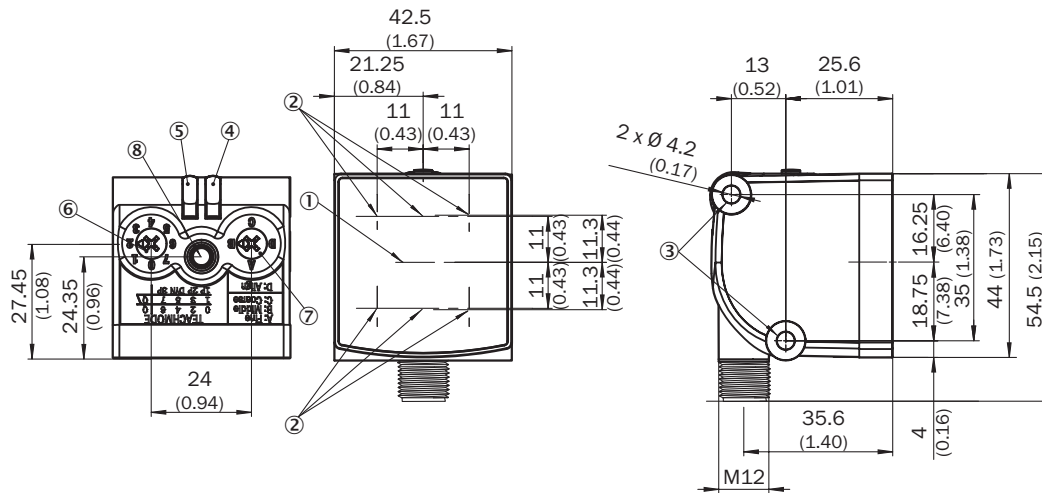

Dimensions in mm (inch)

- ① Center of optical axis, sender
- ② Center of optical axis, receiver
- ③ fixing hole
- ④ LED indicator green: Supply voltage active
- ⑤ Status indicator LED, yellow: Detection of gloss level 1
- ⑥ Teach-in mode, inverting switching output
- ⑦ Sensitivity adjustment (A, B, C) / Operating mode (D)
- ⑧ Teach-in button

Connection diagram Cd-281

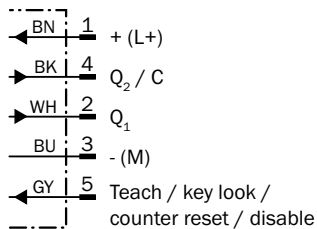







Recommended accessories

Other models and accessories → www.sick.com/Glare

	Brief description	Type	part no.
Mounting systems			
	<ul style="list-style-type: none"> • Description: Plate N11N for universal clamp bracket • Material: Stainless steel • Details: Stainless steel 1.4571 (sheet), Stainless steel 1.4408 (clamp) • Items supplied: Universal clamp (5322627), mounting hardware • Usable for: DeltaPac, Glare, WTD20E 	BEF-KHS-N11N	2071081

	Brief description	Type	part no.
network devices			
		IOLA2US-01101 (SiLink2 Master)	1061790
		SIG200-0A0412200	1089794
		SIG200-0A0G12200	1102605

	Brief description	Type	part no.
connectors and cables			
	<ul style="list-style-type: none"> Description: Sensor/actuator cable, unshielded Connection type head A: Female connector, M12, 5-pin, angled, A-coded Connection type head B: Flying leads Signal type: Sensor/actuator cable Cable: 2 m, 5-wire, PVC Application: Uncontaminated zones, Zones with chemicals 	YG2A15-020VB5XLEAX	2096215
	<ul style="list-style-type: none"> Description: Sensor/actuator cable, unshielded Connection type head A: Female connector, M12, 5-pin, angled, A-coded Connection type head B: Flying leads Signal type: Sensor/actuator cable Cable: 5 m, 5-wire, PVC Application: Uncontaminated zones, Zones with chemicals 	YG2A15-050VB5XLEAX	2096216
	<ul style="list-style-type: none"> Description: Sensor/actuator cable, unshielded Connection type head A: Female connector, M12, 5-pin, straight, A-coded Connection type head B: Flying leads Signal type: Sensor/actuator cable Cable: 2 m, 5-wire, PVC Application: Uncontaminated zones, Zones with chemicals 	YF2A15-020VB5XLEAX	2096239
	<ul style="list-style-type: none"> Description: Sensor/actuator cable, unshielded Connection type head A: Female connector, M12, 5-pin, straight, A-coded Connection type head B: Flying leads Signal type: Sensor/actuator cable Cable: 5 m, 5-wire, PVC Application: Uncontaminated zones, Zones with chemicals 	YF2A15-050VB5XLEAX	2096240
	<ul style="list-style-type: none"> Description: Sensor/actuator cable, unshielded Connection type head A: Female connector, M12, 5-pin, angled, A-coded Connection type head B: Flying leads Signal type: Sensor/actuator cable Cable: 0.6 m, 5-wire, PVC Application: Uncontaminated zones, Zones with chemicals 	YG2A15-C60VB5XLEAX	2145573
	<ul style="list-style-type: none"> Description: Sensor/actuator cable, unshielded Connection type head A: Female connector, M12, 5-pin, angled, A-coded Connection type head B: Flying leads Signal type: Sensor/actuator cable Cable: 1 m, 5-wire, PVC Application: Uncontaminated zones, Zones with chemicals 	YG2A15-010VB5XLEAX	2145574
	<ul style="list-style-type: none"> Description: Sensor/actuator cable, unshielded Connection type head A: Female connector, M12, 5-pin, angled, A-coded Connection type head B: Flying leads Signal type: Sensor/actuator cable Cable: 3 m, 5-wire, PVC Application: Uncontaminated zones, Zones with chemicals 	YG2A15-030VB5XLEAX	2145575
	<ul style="list-style-type: none"> Description: Sensor/actuator cable, unshielded Connection type head A: Female connector, M12, 5-pin, straight, A-coded Connection type head B: Flying leads Signal type: Sensor/actuator cable Cable: 0.6 m, 5-wire, PVC Application: Uncontaminated zones, Zones with chemicals 	YF2A15-C60VB5XLEAX	2145570
	<ul style="list-style-type: none"> Description: Sensor/actuator cable, unshielded Connection type head A: Female connector, M12, 5-pin, straight, A-coded Connection type head B: Flying leads Signal type: Sensor/actuator cable Cable: 3 m, 5-wire, PVC Application: Uncontaminated zones, Zones with chemicals 	YF2A15-030VB5XLEAX	2145572
	<ul style="list-style-type: none"> Description: Unshielded Connection type head A: Male connector, M12, 5-pin, straight, A-coded Connection systems: Screw-type terminals Permitted cross-section: ≤ 0.75 mm² Note: For field bus technology 	STE-1205-G	6022083

SICK AT A GLANCE

SICK is one of the leading manufacturers of intelligent sensors and sensor solutions for industrial applications. A unique range of products and services creates the perfect basis for controlling processes securely and efficiently, protecting individuals from accidents and preventing damage to the environment.

We have extensive experience in a wide range of industries and understand their processes and requirements. With intelligent sensors, we can deliver exactly what our customers need. In application centers in Europe, Asia and North America, system solutions are tested and optimized in accordance with customer specifications. All this makes us a reliable supplier and development partner.

Comprehensive services complete our offering: SICK LifeTime Services provide support throughout the machine life cycle and ensure safety and productivity.

For us, that is “Sensor Intelligence.”

WORLDWIDE PRESENCE:

Contacts and other locations –www.sick.com