



IME30-15BD0ZY2S

IME

INDUCTIVE PROXIMITY SENSORS

SICK
Sensor Intelligence.



Ordering information

Type	part no.
IME30-15BDOZY2S	1068263

Included in delivery: BEF-MU-M30 (1)

Other models and accessories → www.sick.com/IME

Illustration may differ



Detailed technical data

Features

Housing	Metric
Housing	Standard design
Thread size	M30 x 1.5
Diameter	Ø 30 mm
Sensing range S_n	15 mm
Safe sensing range S_a	12.15 mm
Installation type	Flush
Switching frequency	500 Hz
Connection type	Cable, 2-wire, 2 m, Oil-resistant
Output function	NC
Electrical wiring	DC 2-wire
Enclosure rating	IP67 ¹⁾
Items supplied	Mounting nut, brass, nickel-plated (2x)

¹⁾ According to EN 60529.

Mechanics/electronics

Supply voltage	10 V DC ... 30 V DC
Ripple	≤ 10 %
Voltage drop	≤ 4 V ¹⁾ ≤ 4.5 V ²⁾

¹⁾ At $I_a = 30$ mA.

²⁾ At I_a max.

³⁾ Supply voltage U_B and constant ambient temperature T_a .

⁴⁾ Of S_r .

Time delay before availability	≤ 100 ms
Hysteresis	3 % ... 15 %
Reproducibility	≤ 2 % ³⁾ 4)
Temperature drift (of S_r)	± 10 %
EMC	According to EN 60947-5-2
Continuous current I_a	≤ 100 mA
Off-state current	≤ 0.8 mA
Minimum load current	≥ 3 mA
Cable material	PVC
Conductor size	0.25 mm ²
Cable diameter	Ø 3.9 mm
Short-circuit protection	✓
Power-up pulse	≤ 5 ms
Shock and vibration resistance	30 g, 11 ms/10 Hz ... 55 Hz, 1 mm
Ambient operating temperature	-25 °C ... +75 °C
Housing material	Brass, nickel-plated
Sensing face material	Plastic, PA 66
Housing length	70 mm
Thread length	54 mm
Tightening torque, max.	≤ 100 Nm
UL File No.	NRKH.E181493

¹⁾ At I_a = 30 mA.

²⁾ At I_a max.

³⁾ Supply voltage U_B and constant ambient temperature T_a.

⁴⁾ Of S_r.

Safety-related parameters

MTTF_D	1,103 years
DC_{avg}	0 %
T_M (mission time)	20 years

Reduction factors

Note	The values are reference values which may vary
St37 steel (Fe)	1
Stainless steel (V2A, 304)	Approx. 0.8
Aluminum (Al)	Approx. 0.45
Copper (Cu)	Approx. 0.4
Brass (Br)	Approx. 0.4

Installation note

Remark	Associated graphic see "Installation"
B	60 mm
C	30 mm

D	45 mm
F	120 mm

Certificates

EU declaration of conformity	✓
UK declaration of conformity	✓
ACMA declaration of conformity	✓
Moroccan declaration of conformity	✓
China RoHS	✓
cULus certificate	✓

Classifications

ECLASS 5.0	27270101
ECLASS 5.1.4	27270101
ECLASS 6.0	27270101
ECLASS 6.2	27270101
ECLASS 7.0	27270101
ECLASS 8.0	27270101
ECLASS 8.1	27270101
ECLASS 9.0	27270101
ECLASS 10.0	27270101
ECLASS 11.0	27270101
ECLASS 12.0	27274001
ETIM 5.0	EC002714
ETIM 6.0	EC002714
ETIM 7.0	EC002714
ETIM 8.0	EC002714
UNSPSC 16.0901	39122230

Installation note Flush installation

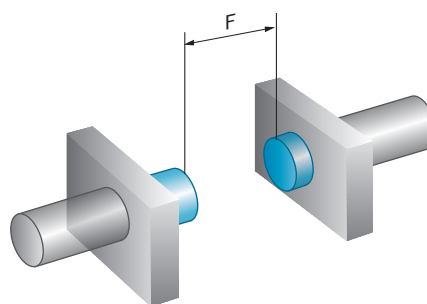

Connection diagram Cd-012



Dimensional drawing IME30 Standard, cable, flush

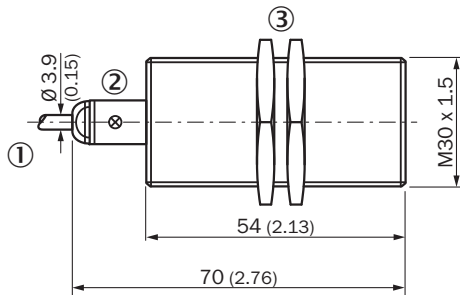











Dimensions in mm (inch)

- ① Connection
- ② Display LED
- ③ Fastening nuts (2x); width across 36, metal

Recommended accessories

Other models and accessories → www.sick.com/IME

	Brief description	Type	part no.
Mounting systems			
	<ul style="list-style-type: none"> • Description: Mounting bracket for M30 sensors • Material: Steel • Details: Steel, zinc coated • Items supplied: Without mounting hardware 	BEF-WN-M30	5308445
	<ul style="list-style-type: none"> • Description: Mounting plate for M30 sensors • Material: Steel • Details: Steel, zinc coated • Items supplied: Without mounting hardware 	BEF-WG-M30	5321871

	Brief description	Type	part no.
connectors and cables			
	<ul style="list-style-type: none"> • Description: Unshielded • Connection type head A: Female connector, M8, 3-pin, straight, A-coded • Connection systems: Screw-type terminals • Permitted cross-section: 0.14 mm² ... 0.5 mm² 	DOS-0803-G	7902077
	<ul style="list-style-type: none"> • Description: Unshielded • Connection type head A: Female connector, M8, 3-pin, angled, A-coded • Connection systems: Solder connection • Permitted cross-section: ≤ 0.25 mm² 	DOS-0803-W	7902078
	<ul style="list-style-type: none"> • Description: Unshielded • Connection type head A: Female connector, M8, 4-pin, straight, A-coded • Connection systems: Screw-type terminals • Permitted cross-section: 0.14 mm² ... 0.5 mm² 	DOS-0804-G	6009974
	<ul style="list-style-type: none"> • Description: Unshielded • Connection type head A: Female connector, M8, 4-pin, angled, A-coded • Connection systems: Solder connection • Permitted cross-section: ≤ 0.25 mm² 	DOS-0804-W	6009975
	<ul style="list-style-type: none"> • Description: Unshielded • Connection type head A: Female connector, M12, 4-pin, straight, A-coded • Connection systems: Screw-type terminals • Permitted cross-section: ≤ 0.75 mm² 	DOS-1204-G	6007302
	<ul style="list-style-type: none"> • Description: Unshielded • Connection type head A: Female connector, M12, 4-pin, angled, A-coded • Connection systems: Screw-type terminals • Permitted cross-section: ≤ 0.75 mm² 	DOS-1204-W	6007303
	<ul style="list-style-type: none"> • Description: Unshielded • Connection type head A: Male connector, M8, 3-pin, straight, A-coded • Connection systems: Screw-type terminals • Permitted cross-section: 0.14 mm² ... 0.5 mm² 	STE-0803-G	6037322
	<ul style="list-style-type: none"> • Description: Unshielded • Connection type head A: Male connector, M8, 4-pin, straight, A-coded • Connection systems: Screw-type terminals • Permitted cross-section: 0.14 mm² ... 0.5 mm² 	STE-0804-G	6037323
	<ul style="list-style-type: none"> • Description: Unshielded • Connection type head A: Male connector, M12, 4-pin, straight, A-coded • Connection systems: Screw-type terminals • Permitted cross-section: ≤ 0.75 mm² 	STE-1204-G	6009932

SICK AT A GLANCE

SICK is one of the leading manufacturers of intelligent sensors and sensor solutions for industrial applications. A unique range of products and services creates the perfect basis for controlling processes securely and efficiently, protecting individuals from accidents and preventing damage to the environment.

We have extensive experience in a wide range of industries and understand their processes and requirements. With intelligent sensors, we can deliver exactly what our customers need. In application centers in Europe, Asia and North America, system solutions are tested and optimized in accordance with customer specifications. All this makes us a reliable supplier and development partner.

Comprehensive services complete our offering: SICK LifeTime Services provide support throughout the machine life cycle and ensure safety and productivity.

For us, that is “Sensor Intelligence.”

WORLDWIDE PRESENCE:

Contacts and other locations –www.sick.com