



GSE6-P3211

G6

PHOTOELECTRIC SENSORS

SICK
Sensor Intelligence.



Ordering information

| Type | part no. |
|------------|----------|
| GSE6-P3211 | 1067659 |

Other models and accessories → www.sick.com/G6

Illustration may differ



Detailed technical data

Features

| | |
|---|-------------------------------------|
| Functional principle | Through-beam photoelectric sensor |
| Sensing range max. | 0 m ... 15 m |
| Sensing range | 0 m ... 10 m |
| Polarisation filter | No |
| Emitted beam | |
| Light source | PinPoint LED ¹⁾ |
| Type of light | Visible red light |
| Light spot size (distance) | Ø 375 mm (12 m) |
| Key LED figures | |
| Wave length | 650 nm |
| Adjustment | Potentiometer, 270° |
| Part number of individual components | 2073534 GS6-D3311 2073535 GE6-P3211 |

¹⁾ Average service life: 100,000 h at T_J = +25 °C.

Safety-related parameters

| | |
|-------------------------------------|-----------|
| MTTF_D | 683 years |
| DC_{avg} | 0% |
| T_M (mission time) | 20 years |

Electronics

| | |
|--|--|
| Supply voltage U_B | 10 V DC ... 30 V DC ¹⁾ |
| Ripple | $\pm 10\%$ ²⁾ |
| Current consumption | 30 mA ³⁾ |
| Protection class | III |
| Digital output | |
| Type | PNP |
| Switching mode | Light/dark switching |
| Switching mode selector | Selectable via light/dark selector |
| Signal voltage PNP HIGH/LOW | $V_S - (\leq 3\text{ V}) / \text{approx. } 0\text{ V}$ |
| Output current I_{max} | $\leq 100\text{ mA}$ ⁴⁾ |
| Response time | $< 500\ \mu\text{s}$ ⁵⁾ |
| Switching frequency | 1,000 Hz ⁶⁾ |
| Circuit protection | A ⁷⁾ B ⁸⁾ D ⁹⁾ |

¹⁾ Limit values when operated in short-circuit protected network: max. 8 A.

²⁾ May not fall below or exceed U_V tolerances.

³⁾ Without load.

⁴⁾ At $U_V > 24\text{ V}$, $I_A \text{ max.} = 50\text{ mA}$.

⁵⁾ Signal transit time with resistive load.

⁶⁾ With light/dark ratio 1:1.

⁷⁾ A = V_S connections reverse-polarity protected.

⁸⁾ B = inputs and output reverse-polarity protected.

⁹⁾ D = outputs overcurrent and short-circuit protected.

Mechanics

| | |
|-------------------------------|-------------------------|
| Housing | Rectangular |
| Dimensions (W x H x D) | 12 mm x 31.5 mm x 21 mm |
| Connection | Connector M8, 3-pin |
| Material | |
| Housing | Plastic, ABS/PC |
| Front screen | Plastic, PMMA |
| Weight | 40 g |

Ambient data

| | |
|--------------------------------------|---|
| Enclosure rating | IP67 |
| Ambient operating temperature | $-25\text{ }^\circ\text{C} \dots +55\text{ }^\circ\text{C}$ ¹⁾ |
| Ambient temperature, storage | $-40\text{ }^\circ\text{C} \dots +70\text{ }^\circ\text{C}$ |
| UL File No. | NRKH.E348498 & NRKH7.E348498 |

¹⁾ Temperature stability following adjustment $\pm 10\text{ }^\circ\text{C}$.

Certificates

| | |
|-------------------------------------|---|
| EU declaration of conformity | ✓ |
| UK declaration of conformity | ✓ |

| | |
|---|---|
| ACMA declaration of conformity | ✓ |
| Moroccan declaration of conformity | ✓ |
| China RoHS | ✓ |
| cULus certificate | ✓ |
| Photobiological safety (DIN EN 62471) certificate | ✓ |

Classifications

| | |
|----------------|----------|
| ECLASS 5.0 | 27270901 |
| ECLASS 5.1.4 | 27270901 |
| ECLASS 6.0 | 27270901 |
| ECLASS 6.2 | 27270901 |
| ECLASS 7.0 | 27270901 |
| ECLASS 8.0 | 27270901 |
| ECLASS 8.1 | 27270901 |
| ECLASS 9.0 | 27270901 |
| ECLASS 10.0 | 27270901 |
| ECLASS 11.0 | 27270901 |
| ECLASS 12.0 | 27270901 |
| ETIM 5.0 | EC002716 |
| ETIM 6.0 | EC002716 |
| ETIM 7.0 | EC002716 |
| ETIM 8.0 | EC002716 |
| UNSPSC 16.0901 | 39121528 |

Dimensional drawing

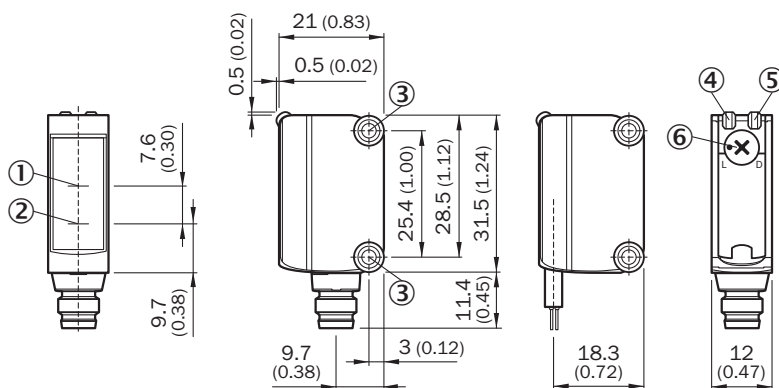

Dimensions in mm (inch)

- ① Optical axis, receiver
- ② Optical axis, sender
- ③ Mounting holes M3
- ④ LED indicator green: Supply voltage active
- ⑤ LED indicator yellow: Status of received light beam
- ⑥ Light/ dark rotary switch: L = light switching, D = dark switching

Adjustments Adjustment possibility

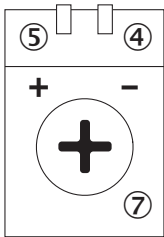

- ④ LED indicator green: Supply voltage active
- ⑤ LED indicator yellow: Status of received light beam
- ⑦ Sensitivity control: potentiometer

Connection type

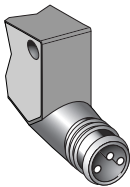

Connection diagram Cd-051

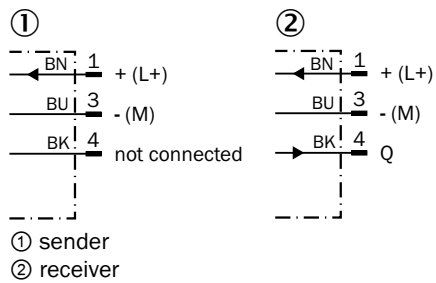

Characteristic curve With GE6-P11111, GE6-N11111, GE6-P1111S63

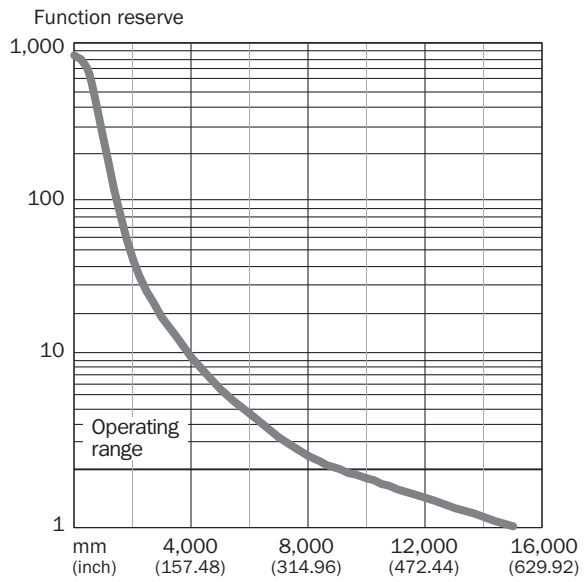

Light spot size

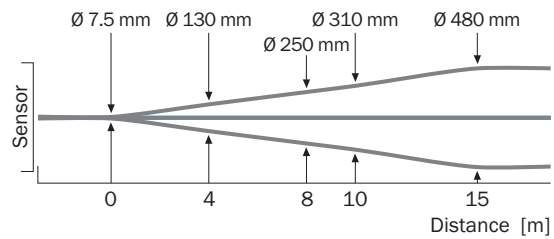



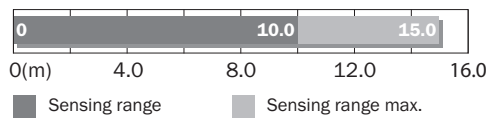



Sensing range diagram



Recommended accessories

Other models and accessories → www.sick.com/G6

| | Brief description | Type | part no. |
|---|---|--------------------|----------|
| Mounting systems | | | |
|  | <ul style="list-style-type: none"> Description: Clamp bar to fix G6 sensors on rods of 12 mm, clamp-on design up to 4 mm wall thickness Material: Steel Details: Aluminum (clamp bar), stainless steel (bracket) Items supplied: Clamp bar mounting and clamp function, mounting bracket, mounting hardware | BEF-KHS-IS12G6 | 2086865 |
|  | <ul style="list-style-type: none"> Material: Stainless steel Details: Stainless steel (1.4301) Suitable for: W4S, W4S | BEF-WN-G6 | 2062909 |
|  | <ul style="list-style-type: none"> Description: Mounting bracket for wall mounting Material: Stainless steel Details: Stainless steel Items supplied: Mounting hardware included Suitable for: W8, W8G, W8 Laser, W8 Inox, G6, G6 Inox, W100 Laser, W100-2, KTM Core, KTM Prime, CSM, LUTM, W4S | BEF-W100-A | 5311520 |
| connectors and cables | | | |
|  | <ul style="list-style-type: none"> Description: Unshielded Connection type head A: Male connector, M8, 3-pin, straight, A-coded Connection systems: Screw-type terminals Permitted cross-section: 0.14 mm² ... 0.5 mm² | STE-0803-G | 6037322 |
|  | <ul style="list-style-type: none"> Description: Sensor/actuator cable, unshielded Connection type head A: Female connector, M8, 3-pin, straight, A-coded Connection type head B: Flying leads Signal type: Sensor/actuator cable Cable: 5 m, 3-wire, PVC Application: Uncontaminated zones, Zones with chemicals | YF8U13-050VA1XLEAX | 2095884 |
|  | <ul style="list-style-type: none"> Description: Sensor/actuator cable, unshielded Connection type head A: Female connector, M8, 3-pin, straight, A-coded Connection type head B: Flying leads Signal type: Sensor/actuator cable Cable: 5 m, 3-wire, PUR, halogen-free Application: Drag chain operation, Zones with oils and lubricants, Robot, Drag chain operation | YF8U13-050UA1XLEAX | 2094788 |

SICK AT A GLANCE

SICK is one of the leading manufacturers of intelligent sensors and sensor solutions for industrial applications. A unique range of products and services creates the perfect basis for controlling processes securely and efficiently, protecting individuals from accidents and preventing damage to the environment.

We have extensive experience in a wide range of industries and understand their processes and requirements. With intelligent sensors, we can deliver exactly what our customers need. In application centers in Europe, Asia and North America, system solutions are tested and optimized in accordance with customer specifications. All this makes us a reliable supplier and development partner.

Comprehensive services complete our offering: SICK LifeTime Services provide support throughout the machine life cycle and ensure safety and productivity.

For us, that is “Sensor Intelligence.”

WORLDWIDE PRESENCE:

Contacts and other locations –www.sick.com