



# WL2SG-2E3235

W2

PHOTOELECTRIC SENSORS

**SICK**  
Sensor Intelligence.



Illustration may differ



### Ordering information

Type	part no.
WL2SG-2E3235	1065936

**Included in delivery:** SCREW SET W2S/G2S (1)

Other models and accessories → [www.sick.com/W2](http://www.sick.com/W2)

### Detailed technical data

#### Features

<b>Functional principle</b>	Photoelectric retro-reflective sensor
<b>Functional principle detail</b>	Without reflector minimum distance (autocollimation/coaxial optics)
<b>Dimensions (W x H x D)</b>	7.7 mm x 21.8 mm x 13.5 mm
<b>Housing design (light emission)</b>	Rectangular
<b>Sensing range max.</b>	0 m ... 1.2 m <sup>1)</sup>
<b>Sensing range</b>	0 m ... 0.55 m <sup>1)</sup>
<b>Type of light</b>	Visible red light
<b>Light source</b>	PinPoint LED <sup>2)</sup>
<b>Light spot size (distance)</b>	Ø 12 mm (250 mm)
<b>Wave length</b>	640 nm
<b>Adjustment</b>	Cable
<b>AutoAdapt</b>	✓
<b>Special applications</b>	Detecting transparent objects

<sup>1)</sup> Reflector P250F.

<sup>2)</sup> Average service life: 100,000 h at T<sub>J</sub> = +25 °C.

## Mechanics/electronics

<b>Supply voltage <math>U_B</math></b>	10 V DC ... 30 V DC <sup>1)</sup>
<b>Ripple</b>	< 5 V <sub>pp</sub> <sup>2)</sup>
<b>Current consumption</b>	20 mA <sup>3)</sup>
<b>Switching output</b>	NPN
<b>Switching mode</b>	Dark switching
<b>Output current <math>I_{max}</math></b>	≤ 50 mA
<b>Response time</b>	< 0.5 ms <sup>4)</sup>
<b>Switching frequency</b>	1,000 Hz <sup>5)</sup>
<b>Connection type</b>	Cable with M8 male connector, 4-pin, 200 mm <sup>6)</sup>
<b>Cable material</b>	Plastic, PVC
<b>Conductor cross section</b>	0.09 mm <sup>2</sup>
<b>Cable diameter</b>	Ø 3 mm
<b>Circuit protection</b>	A <sup>7)</sup> B <sup>8)</sup> D <sup>9)</sup>
<b>Polarizing filter</b>	✓
<b>Housing material</b>	Plastic, ABS/PC
<b>Optics material</b>	Plastic, PMMA
<b>Enclosure rating</b>	IP67
<b>Ambient operating temperature</b>	-20 °C ... +50 °C
<b>Ambient temperature, storage</b>	-40 °C ... +75 °C
<b>UL File No.</b>	NRKH.E181493

<sup>1)</sup> Limit values.

<sup>2)</sup> May not fall below or exceed  $U_V$  tolerances.

<sup>3)</sup> Without load.

<sup>4)</sup> Signal transit time with resistive load.

<sup>5)</sup> With light/dark ratio 1:1.

<sup>6)</sup> Do not bend below 0 °C.

<sup>7)</sup> A =  $V_S$  connections reverse-polarity protected.

<sup>8)</sup> B = output reverse-polarity protected.

<sup>9)</sup> D = outputs overcurrent and short-circuit protected.

## Safety-related parameters

<b>MTTF<sub>D</sub></b>	2,001 years
<b>DC<sub>avg</sub></b>	0 %

## Certificates

<b>EU declaration of conformity</b>	✓
<b>UK declaration of conformity</b>	✓
<b>ACMA declaration of conformity</b>	✓
<b>Moroccan declaration of conformity</b>	✓
<b>China RoHS</b>	✓
<b>cULus certificate</b>	✓

<b>Photobiological safety (DIN EN 62471) certificate</b>	✓
--	---

Classifications

<b>ECLASS 5.0</b>	27270902
<b>ECLASS 5.1.4</b>	27270902
<b>ECLASS 6.0</b>	27270902
<b>ECLASS 6.2</b>	27270902
<b>ECLASS 7.0</b>	27270902
<b>ECLASS 8.0</b>	27270902
<b>ECLASS 8.1</b>	27270902
<b>ECLASS 9.0</b>	27270902
<b>ECLASS 10.0</b>	27270902
<b>ECLASS 11.0</b>	27270902
<b>ECLASS 12.0</b>	27270902
<b>ETIM 5.0</b>	EC002717
<b>ETIM 6.0</b>	EC002717
<b>ETIM 7.0</b>	EC002717
<b>ETIM 8.0</b>	EC002717
<b>UNSPSC 16.0901</b>	39121528

Connection diagram Cd-092

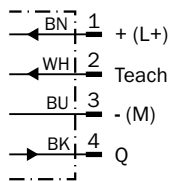

### Characteristic curve WL2S-2

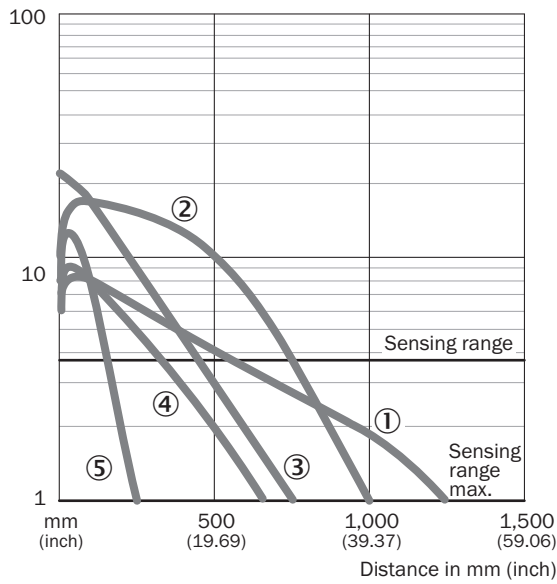

- ① Reflector P250F
- ② Reflector PL20F
- ③ Reflective tape REF-AC1000
- ④ PL10F reflector
- ⑤ Reflector PL8FH

### Light spot size WL2S-2



#### Dimensions in mm (inch)

Sensing range	Spot diameter
<b>20</b> (0.79)	3.4 (0.13)
<b>100</b> (3.94)	6.5 (0.26)
<b>250</b> (9.84)	12.0 (0.47)
<b>500</b> (19.69)	34.0 (1.34)
<b>1,000</b> (39.37)	48.0 (1.89)
<b>1,200</b> (47.24)	60.0 (2.36)

### Sensing range diagram WL2S-2

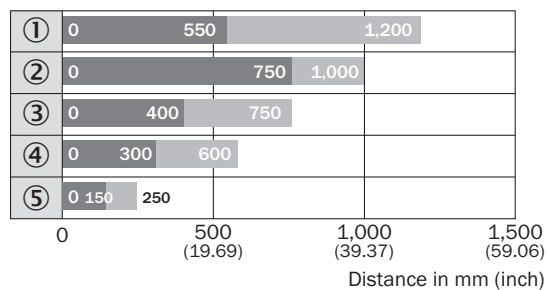

■ Sensing range      ■ Sensing range max.

- ① Reflector P250F
- ② Reflector PL20F
- ③ Reflective tape REF-AC1000
- ④ PL10F reflector
- ⑤ Reflector PL8FH

### Dimensional drawing WL2S-2

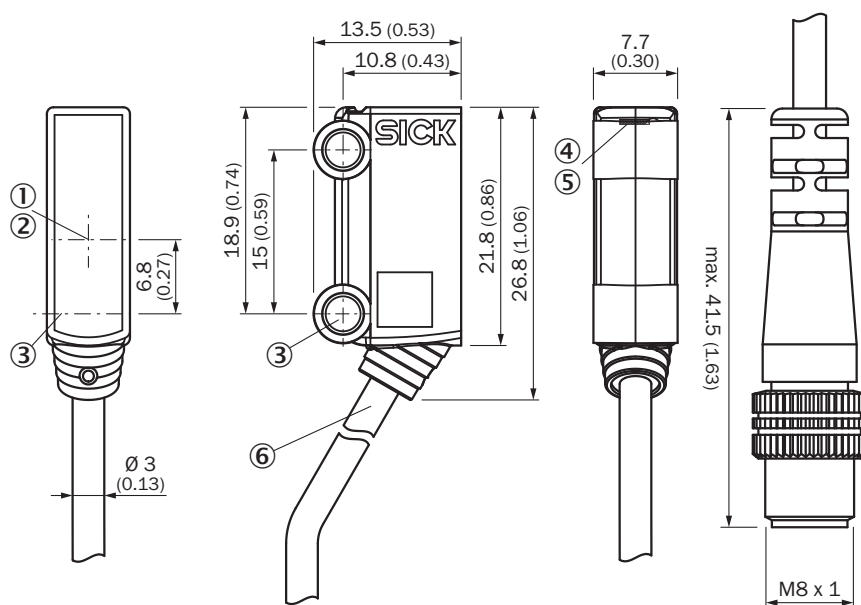





Dimensions in mm (inch)

- ① Optical axis, receiver
- ② Optical axis, sender
- ③ Middle axis fixing hole  $\varnothing 3.2$  mm
- ④ LED indicator green: Supply voltage active
- ⑤ LED indicator yellow: Status of received light beam
- ⑥ Connection

## Recommended accessories

Other models and accessories → [www.sick.com/W2](http://www.sick.com/W2)

	Brief description	Type	part no.
Mounting systems			
	<ul style="list-style-type: none"> <li><b>Description:</b> Mounting bracket for floor mounting</li> <li><b>Material:</b> Steel</li> <li><b>Details:</b> Steel, zinc coated</li> <li><b>Items supplied:</b> Without mounting hardware</li> <li><b>Suitable for:</b> W2S-2</li> </ul>	BEF-W2S-A	4034748
reflectors and optics			
	<ul style="list-style-type: none"> <li><b>Description:</b> Fine triple reflector, screw connection, suitable for laser sensors</li> <li><b>Dimensions:</b> 20 mm 32 mm</li> <li><b>Ambient operating temperature:</b> -30 °C ... +65 °C</li> </ul>	PL10F	5311210
connectors and cables			
	<ul style="list-style-type: none"> <li><b>Description:</b> Sensor/actuator cable, unshielded</li> <li><b>Connection type head A:</b> Female connector, M8, 4-pin, straight, A-coded</li> <li><b>Connection type head B:</b> Flying leads</li> <li><b>Signal type:</b> Sensor/actuator cable</li> <li><b>Cable:</b> 5 m, 4-wire, PVC</li> <li><b>Application:</b> Uncontaminated zones, Zones with chemicals</li> </ul>	YF8U14-050VA3XLEAX	2095889
	<ul style="list-style-type: none"> <li><b>Description:</b> Sensor/actuator cable, unshielded</li> <li><b>Connection type head A:</b> Female connector, M8, 4-pin, straight, A-coded</li> <li><b>Connection type head B:</b> Flying leads</li> <li><b>Signal type:</b> Sensor/actuator cable</li> <li><b>Cable:</b> 5 m, 4-wire, PUR, halogen-free</li> <li><b>Application:</b> Drag chain operation, Zones with oils and lubricants, Robot, Drag chain operation</li> </ul>	YF8U14-050UA3XLEAX	2094792
	<ul style="list-style-type: none"> <li><b>Description:</b> Unshielded</li> <li><b>Connection type head A:</b> Male connector, M8, 4-pin, straight, A-coded</li> <li><b>Connection systems:</b> Screw-type terminals</li> <li><b>Permitted cross-section:</b> 0.14 mm<sup>2</sup> ... 0.5 mm<sup>2</sup></li> </ul>	STE-0804-G	6037323

## SICK AT A GLANCE

SICK is one of the leading manufacturers of intelligent sensors and sensor solutions for industrial applications. A unique range of products and services creates the perfect basis for controlling processes securely and efficiently, protecting individuals from accidents and preventing damage to the environment.

We have extensive experience in a wide range of industries and understand their processes and requirements. With intelligent sensors, we can deliver exactly what our customers need. In application centers in Europe, Asia and North America, system solutions are tested and optimized in accordance with customer specifications. All this makes us a reliable supplier and development partner.

Comprehensive services complete our offering: SICK LifeTime Services provide support throughout the machine life cycle and ensure safety and productivity.

For us, that is “Sensor Intelligence.”

## WORLDWIDE PRESENCE:

Contacts and other locations –[www.sick.com](http://www.sick.com)