



# GL10-N1111

G10

PHOTOELECTRIC SENSORS

**SICK**  
Sensor Intelligence.



Illustration may differ



## Ordering information

Type	part no.
GL10-N1111	1065880

Other models and accessories → [www.sick.com/G10](http://www.sick.com/G10)

## Detailed technical data

### Features

<b>Functional principle</b>	Photoelectric retro-reflective sensor
<b>Functional principle detail</b>	With minimum distance to reflector (dual lens system)
<b>Dimensions (W x H x D)</b>	20 mm x 50 mm x 39 mm
<b>Housing design (light emission)</b>	Rectangular
<b>Sensing range max.</b>	0.08 m ... 15 m <sup>1)</sup> 0.08 m ... 12 m <sup>2)</sup>
<b>Sensing range</b>	0.15 m ... 12 m <sup>1)</sup> 0.15 m ... 10 m <sup>2)</sup>
<b>Type of light</b>	Visible red light
<b>Light source</b>	PinPoint LED <sup>3)</sup>
<b>Light spot size (distance)</b>	Ø 58 mm (5 m)
<b>Wave length</b>	625 nm
<b>Adjustment</b>	None

<sup>1)</sup> Reflector PL80A.

<sup>2)</sup> Reflector P250.

<sup>3)</sup> Average service life: 100,000 h at T<sub>U</sub> = +25 °C.

## Mechanics/electronics

<b>Supply voltage <math>U_B</math></b>	10 V DC ... 30 V DC <sup>1)</sup>
<b>Ripple</b>	< 5 V <sub>pp</sub> <sup>2)</sup>
<b>Current consumption</b>	20 mA
<b>Switching output</b>	NPN
<b>Switching mode</b>	Light/dark switching
<b>Switching mode selector</b>	Selectable via light/dark selector
<b>Output current <math>I_{max}</math></b>	≤ 100 mA
<b>Response time</b>	≤ 500 μs <sup>3)</sup>
<b>Switching frequency</b>	1,000 Hz <sup>4)</sup>
<b>Connection type</b>	Cable, 3-wire, 2 m <sup>5)</sup>
<b>Cable material</b>	Plastic, PVC
<b>Conductor cross section</b>	0.14 mm <sup>2</sup>
<b>Circuit protection</b>	A <sup>6)</sup> B <sup>7)</sup> C <sup>8)</sup> D <sup>9)</sup>
<b>Protection class</b>	III
<b>Weight</b>	90 g
<b>Polarizing filter</b>	✓
<b>Housing material</b>	Plastic, ABS/PMMA
<b>Enclosure rating</b>	IP67
<b>Electromagnetic compatibility (EMC)</b>	EN 60947-5-2
<b>Ambient operating temperature</b>	-30 °C ... +60 °C
<b>Ambient temperature, storage</b>	-40 °C ... +70 °C
<b>UL File No.</b>	NRKH.E348498 & NRKH7.E348498
<b>More standards</b>	UL325 <sup>10)</sup>

<sup>1)</sup> Limit values when operated in short-circuit protected network: max. 8 A.

<sup>2)</sup> May not fall below or exceed  $U_V$  tolerances.

<sup>3)</sup> Signal transit time with resistive load.

<sup>4)</sup> With light/dark ratio 1:1.

<sup>5)</sup> Do not bend below 0 °C.

<sup>6)</sup> A =  $V_S$  connections reverse-polarity protected.

<sup>7)</sup> B = inputs and output reverse-polarity protected.

<sup>8)</sup> C = interference suppression.

<sup>9)</sup> D = outputs overcurrent and short-circuit protected.

<sup>10)</sup> Complies with the UL325 standard when used with sturdy protection hood (e.g. BEF-G10WSG, 2071960).

## Certificates

<b>EU declaration of conformity</b>	✓
<b>UK declaration of conformity</b>	✓
<b>ACMA declaration of conformity</b>	✓
<b>Moroccan declaration of conformity</b>	✓
<b>China RoHS</b>	✓

<b>cULus certificate</b>	✓
<b>Photobiological safety (DIN EN 62471) certificate</b>	✓

Classifications

<b>ECLASS 5.0</b>	27270902
<b>ECLASS 5.1.4</b>	27270902
<b>ECLASS 6.0</b>	27270902
<b>ECLASS 6.2</b>	27270902
<b>ECLASS 7.0</b>	27270902
<b>ECLASS 8.0</b>	27270902
<b>ECLASS 8.1</b>	27270902
<b>ECLASS 9.0</b>	27270902
<b>ECLASS 10.0</b>	27270902
<b>ECLASS 11.0</b>	27270902
<b>ECLASS 12.0</b>	27270902
<b>ETIM 5.0</b>	EC002717
<b>ETIM 6.0</b>	EC002717
<b>ETIM 7.0</b>	EC002717
<b>ETIM 8.0</b>	EC002717
<b>UNSPSC 16.0901</b>	39121528

Adjustments

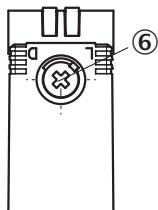

⑥ Light/dark selector

Connection diagram Cd-044

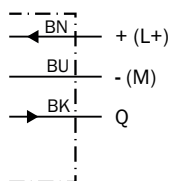

### Characteristic curve GL10

Operating reserve

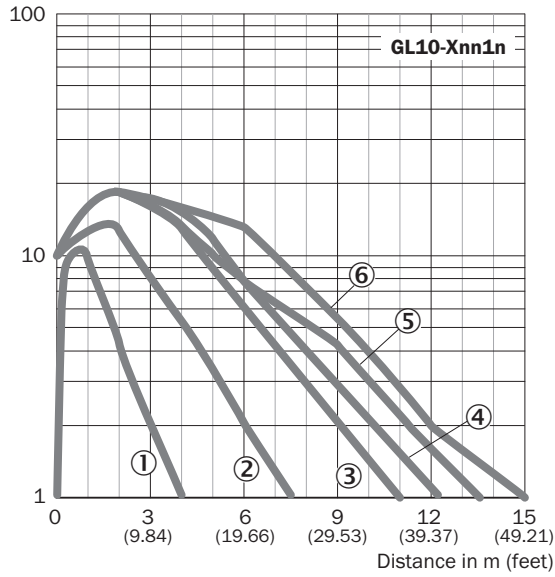

### Light spot size

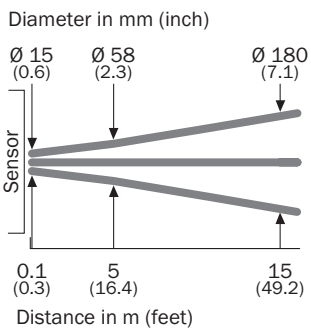

### Sensing range diagram GL10



- Sensing range      ■ Sensing range max.
- ① Reflective tape REF-IRF-56
- ② Reflector PL20A

- ③ Reflector PL30A
- ④ Reflector P250
- ⑤ Reflector PL40A
- ⑥ Reflector PL80A

Dimensional drawing CableGTE10, GL10, GL10G, DC, connector

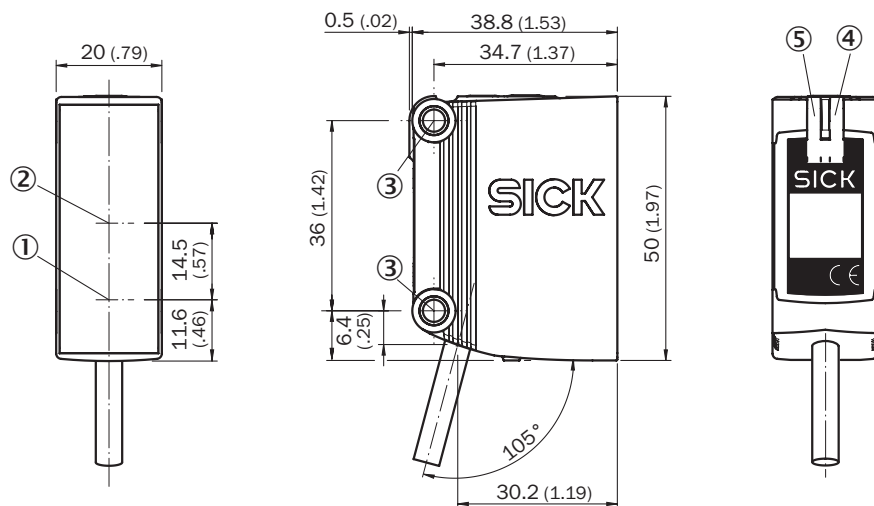





Dimensions in mm (inch)

- ① Center of optical axis, sender
- ② Center of optical axis, receiver
- ③ Mounting hole,  $\varnothing$  4.2 mm
- ④ LED indicator yellow: Status of received light beam
- ⑤ LED indicator green: power on

## Recommended accessories

Other models and accessories → [www.sick.com/G10](http://www.sick.com/G10)

	Brief description	Type	part no.
Mounting systems			
	<ul style="list-style-type: none"> <li><b>Description:</b> Q-Lock, bar clamp system for G10 and reflector P250</li> <li><b>Material:</b> Zinc diecast, steel</li> <li><b>Details:</b> Die-cast zinc, steel, zinc coated</li> <li><b>Suitable for:</b> G10 and reflector P250</li> </ul>	BEF-KHSQ12R01	2071260
	<ul style="list-style-type: none"> <li><b>Description:</b> Mounting bracket with articulated arm</li> <li><b>Material:</b> Steel</li> <li><b>Details:</b> Steel, zinc coated</li> <li><b>Items supplied:</b> Mounting hardware included</li> <li><b>Suitable for:</b> W16, W26, W11, W12, W23, W27, Dx50, W280, G10</li> </ul>	BEF-WN-MULTI2	2093945
	<ul style="list-style-type: none"> <li><b>Description:</b> Universal mounting bracket for reflectors</li> <li><b>Dimensions (W x H x L):</b> 85 mm x 90 mm x 35 mm</li> <li><b>Material:</b> Steel</li> <li><b>Details:</b> Steel, zinc coated</li> <li><b>Suitable for:</b> C110A, P250, PL20, PL30A, PL40A, PL80A</li> </ul>	BEF-WN-REFX	2064574
reflectors and optics			
	<ul style="list-style-type: none"> <li><b>Description:</b> Rectangular, screw connection</li> <li><b>Dimensions:</b> 51 mm 61 mm</li> <li><b>Ambient operating temperature:</b> -30 °C ... +65 °C</li> </ul>	P250	5304812
connectors and cables			
	<ul style="list-style-type: none"> <li><b>Description:</b> Unshielded</li> <li><b>Connection type head A:</b> Male connector, M8, 3-pin, straight, A-coded</li> <li><b>Connection systems:</b> Screw-type terminals</li> <li><b>Permitted cross-section:</b> 0.14 mm<sup>2</sup> ... 0.5 mm<sup>2</sup></li> </ul>	STE-0803-G	6037322

## SICK AT A GLANCE

SICK is one of the leading manufacturers of intelligent sensors and sensor solutions for industrial applications. A unique range of products and services creates the perfect basis for controlling processes securely and efficiently, protecting individuals from accidents and preventing damage to the environment.

We have extensive experience in a wide range of industries and understand their processes and requirements. With intelligent sensors, we can deliver exactly what our customers need. In application centers in Europe, Asia and North America, system solutions are tested and optimized in accordance with customer specifications. All this makes us a reliable supplier and development partner.

Comprehensive services complete our offering: SICK LifeTime Services provide support throughout the machine life cycle and ensure safety and productivity.

For us, that is “Sensor Intelligence.”

## WORLDWIDE PRESENCE:

Contacts and other locations –[www.sick.com](http://www.sick.com)