



CLV640-0831S01

CLV64x

FIXED MOUNT BARCODE SCANNERS

SICK
Sensor Intelligence.

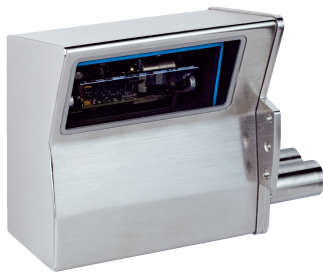

Ordering information

Type	part no.
CLV640-0831S01	1064718

Other models and accessories → www.sick.com/CLV64x



Detailed technical data

Features

Version	Standard Density
Connection type	Ethernet
Reading field	Oscillating mirror
Sensor type	Oscillating mirror
Optical focus	Dynamic focus control
Light source	Light spot, laser, Visible, Red, 655 nm
Light spot	Circular
Laser class	2, complies with 21 CFR 1040.10 except for the conformance according to "Laser Notice No. 56" from May 8, 2019 (EN 60825-1:2014+A11:2021, IEC 60825-1:2014)
Aperture angle	≤ 50°
Reading distance	47 mm ... 798 mm ¹⁾
Scanning frequency	400 Hz ... 1,200 Hz
Code resolution	0.2 mm ... 1 mm
Oscillating mirror functions	Fixed (adjustable position), oscillating (variable or fixed amplitude), one shot
Oscillation frequency	0.5 Hz ... 6.25 Hz
Angle of deflection	-20° ... 20°

¹⁾ For details see reading field diagram.

Mechanics/electronics

Connection type	2 x M12 cylindrical connectors (1 x 17-pin male connector, 4-pin female connector)
Supply voltage	18 V DC ... 30 V DC

¹⁾ At 25 °C.

Power consumption	6.5 W
Housing material	Stainless steel
Housing color	Stainless steel (unpainted)
Window material	Plastic
Enclosure rating	IP69K (DIN 40 050, part 9)
Protection class	III (EN 61140)
Weight	1,230 g, without connecting cable
Dimensions (L x W x H)	121 mm x 164 mm x 84 mm
MTBF	100,000 h
MTTF	40,000 h (Laser diode) ¹⁾

¹⁾ At 25 °C.

Performance

Readable code structures	1D codes
Bar code types	All current code types, Code 39, Code 128, Code 93, Codabar, GS1-128 / EAN 128, UPC / GTIN / EAN, Interleaved 2 of 5, Pharmacode, GS1 DataBar, Telepen, MSI/Plessey
Code printing process	Label (printed codes)
Print ratio	2:1 ... 3:1
No. of codes per scan	1 ... 20 (Standard decoder) 1 ... 6 (SMART decoder)
No. of codes per reading interval	1 ... 50 (auto-discriminating)
No. of characters per reading interval	5,000 500 (for multiplexer function in CAN operation)
No. of multiple readings	1 ... 99

Interfaces

Ethernet	✓ , TCP/IP
Function	Data interface (read result output), Service interface
Data transmission rate	10/100 MBit/s
PROFINET	✓
Function	PROFINET Single Port, PROFINET Dual Port (optional via external connection module CDF600-2)
Data transmission rate	10/100 MBit/s
EtherNet/IP™	✓
Data transmission rate	10/100 MBit/s
EtherCAT®	✓
Type of fieldbus integration	Optional over external fieldbus module CDF600
Serial	✓ , RS-232, RS-422, RS-485
Function	Data interface (read result output), Service interface
Data transmission rate	2,400 Baud ... 115.2 kBaud, AUX: 57.6 kBaud (RS-232)
CAN	✓
Function	SICK CAN sensor network CSN (CAN controller/CAN device, multiplexer/server)
Data transmission rate	20 kbit/s ... 1 Mbit/s
CANopen	✓
Data transmission rate	20 kbit/s ... 1 Mbit/s

PROFIBUS DP	✓
Type of fieldbus integration	Optional over external fieldbus module CDF600-2
Digital inputs	4 ("Sensor 1", "Sensor 2", 2 inputs via optional CMC600 in CDB650)
Digital outputs	4 ("Result 1", "Result 2", 2 via optional CMC600 parameter memory in CDB650)
Reading pulse	Digital inputs, serial interface, auto pulse, CAN
Configuration software	SOPAS ET

Ambient data

Electromagnetic compatibility (EMC)	EN 61000-6-3 (2001-10) / EN 61000-6-2:2005
Vibration resistance	EN 60068-2-6 (1995)
Shock resistance	EN 60068-2-27 (1993)
Ambient operating temperature	0 °C ... +40 °C
Storage temperature	-20 °C ... +70 °C
Relative humidity	90 %, Non-condensing
Ambient light immunity	2,000 lx, on barcode
Bar code print contrast (PCS)	≥ 60 %

Certificates

EU declaration of conformity	✓
UK declaration of conformity	✓
ACMA declaration of conformity	✓
China RoHS	✓
Ethercat certificate	✓
Profinet certificate	✓
Laser safety (IEC 60825-1) declaration of manufacturer	✓
Information according to Art. 3 of Data Act (Regulation EU 2023/2854)	✓
4Dpro	✓

Classifications

ECLASS 5.0	27280102
ECLASS 5.1.4	27280102
ECLASS 6.0	27280102
ECLASS 6.2	27280102
ECLASS 7.0	27280102
ECLASS 8.0	27280102
ECLASS 8.1	27280102
ECLASS 9.0	27280102
ECLASS 10.0	27280102
ECLASS 11.0	27280102
ECLASS 12.0	27280102
ETIM 5.0	EC002550
ETIM 6.0	EC002550

ETIM 7.0	EC002550
ETIM 8.0	EC002550
UNSPSC 16.0901	43211701

Dimensional drawing

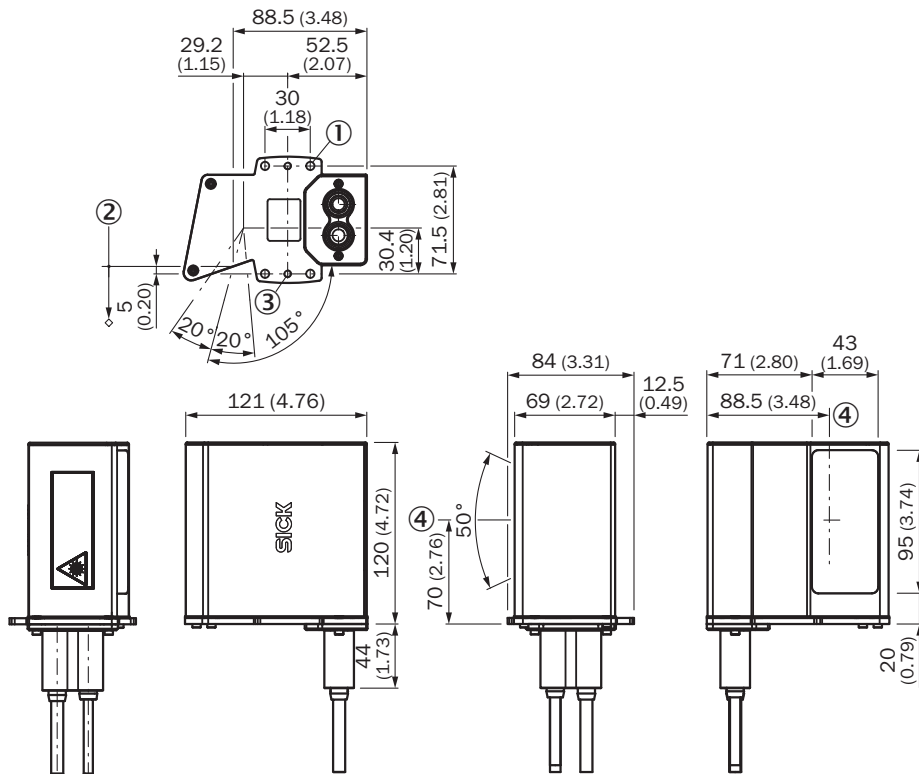

Dimensions in mm (inch)

- ① mounting holes, \varnothing 5.5 mm (4 x)
- ② reference point for reading distance (from housing edge to object)
- ③ threaded holes, M5 (2 x)
- ④ position light emission (oscillating mirror in central position)

Reading field diagram

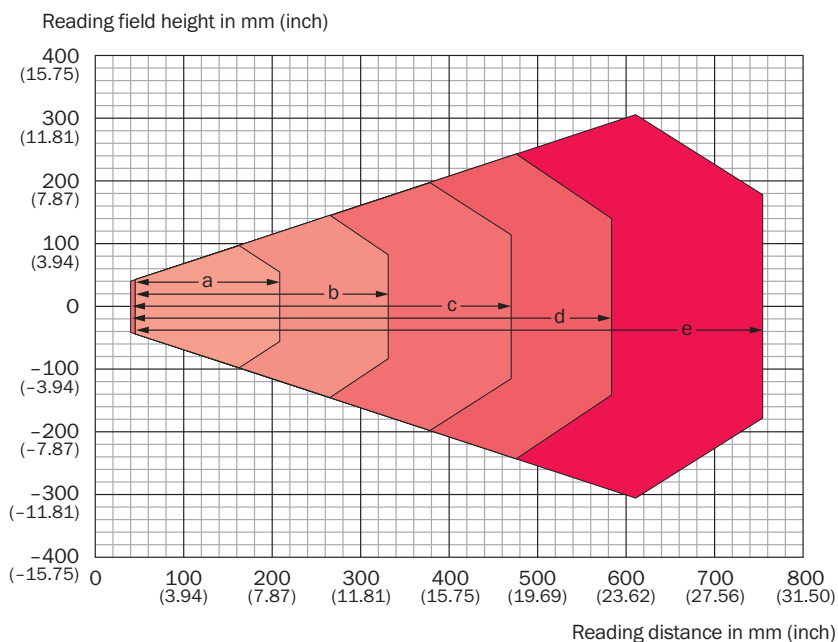

Resolution

- a: 0.20 mm (7.9 mil)
- b: 0.25 mm (9.8 mil)
- c: 0.35 mm (13.8 mil)
- d: 0.50 mm (19.7 mil)
- e: 1.00 mm (39.4 mil)

The depth of field is reduced by approx. 10% for devices with plastic lenses.

Deflection width

Deflection range in mm (inch)

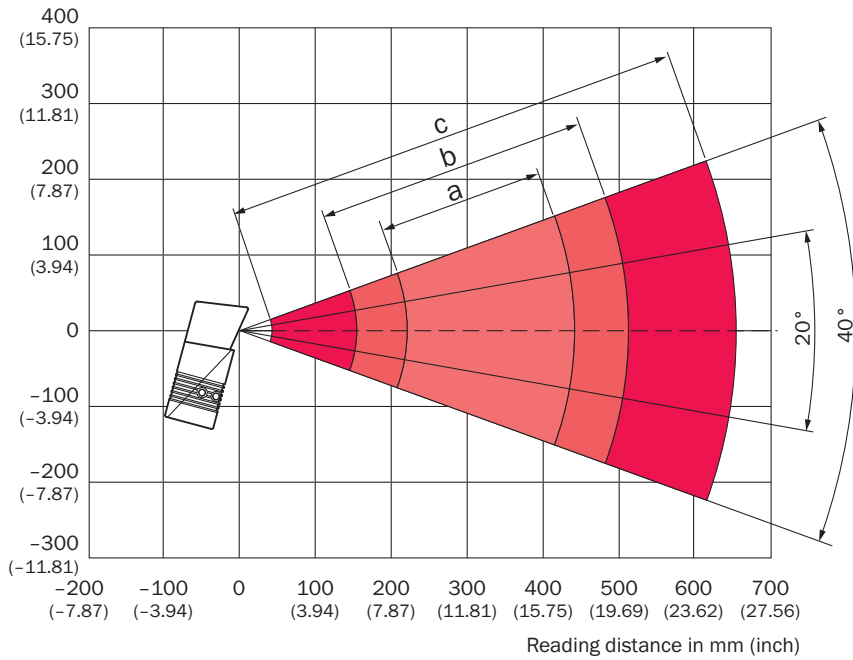

① diagram applies to focus position of 280 mm

Deflection width

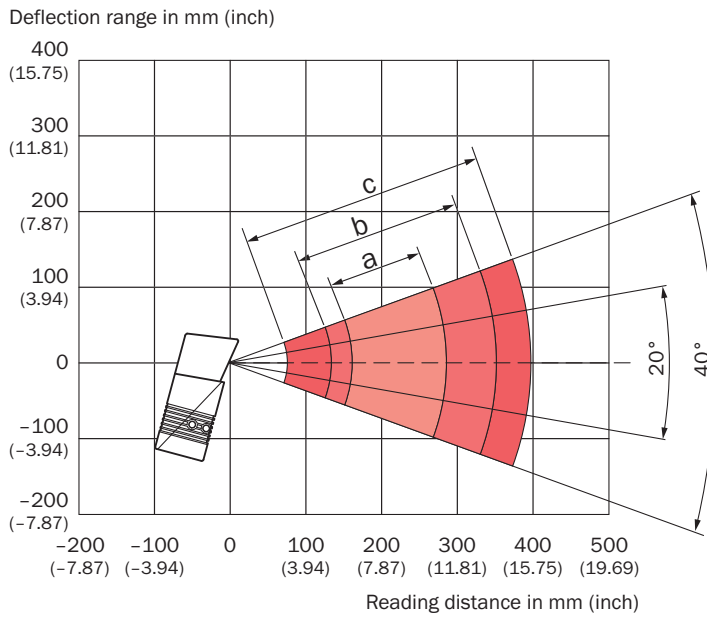

Resolution

- a: 0.25 mm (9.8 mil)
- b: 0.35 mm (13.8 mil)
- c: 0.50 mm (19.7 mil)

① diagram applies to focus position of 215 mm

Deflection width

Deflection range in mm (inch)

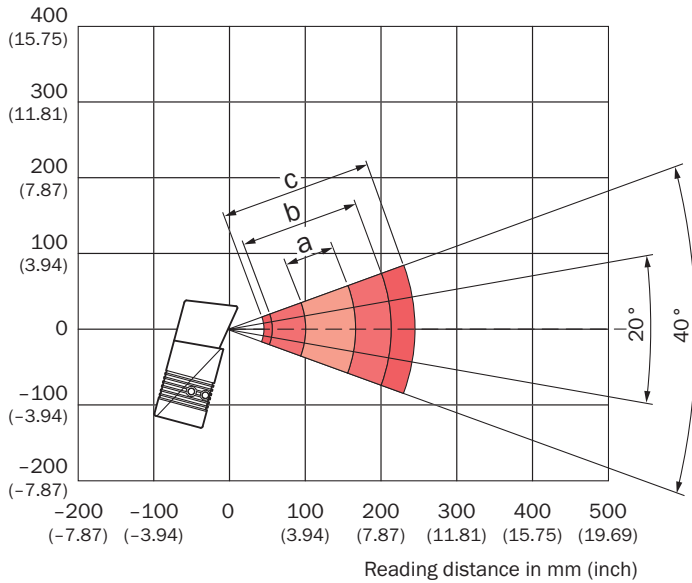



Resolution



- a: 0.20 mm (7.9 mil)
- b: 0.35 mm (13.8 mil)
- c: 0.50 mm (19.7 mil)

① diagram applies to focus position of 140 mm

Recommended accessories

Other models and accessories → www.sick.com/CLV64x

	Brief description	Type	part no.
integration modules and adapters			
	<ul style="list-style-type: none"> Description: External parameter memory for integration in CDB620/CDB650/CDM42x 	CMC600-101	1042259
Mounting systems			
	<ul style="list-style-type: none"> Description: Bracket 	Mounting bracket	2068600

	Brief description	Type	part no.
connectors and cables			
	<ul style="list-style-type: none"> • Connection type head A: Female connector, M12, 17-pin, straight, A-coded • Connection type head B: Male connector, M12, 17-pin, straight, A-coded • Signal type: Power, serial, CAN, digital I/Os • Cable: 3 m, 17-wire • Description: Power, suitable for 2 A, shielded, Serial, CAN, Digital I/Os • Application: Drag chain operation 	YM2A8D-030XXXF2A8D	6051194
	<ul style="list-style-type: none"> • Connection type head A: Male connector, M12, 4-pin, straight, D-coded • Connection type head B: Male connector, RJ45, 8-pin, straight • Signal type: Ethernet, PROFINET • Cable: 2 m, 4-wire, AWG26, PVC • Description: Ethernet, shielded, PROFINET 	YM2D24-020E-B2MRJA4	6050198
Junction boxes			
		CDB650-204	1064114

SICK AT A GLANCE

SICK is one of the leading manufacturers of intelligent sensors and sensor solutions for industrial applications. A unique range of products and services creates the perfect basis for controlling processes securely and efficiently, protecting individuals from accidents and preventing damage to the environment.

We have extensive experience in a wide range of industries and understand their processes and requirements. With intelligent sensors, we can deliver exactly what our customers need. In application centers in Europe, Asia and North America, system solutions are tested and optimized in accordance with customer specifications. All this makes us a reliable supplier and development partner.

Comprehensive services complete our offering: SICK LifeTime Services provide support throughout the machine life cycle and ensure safety and productivity.

For us, that is “Sensor Intelligence.”

WORLDWIDE PRESENCE:

Contacts and other locations –www.sick.com