



VSPM-6B2113

Inspector

2D MACHINE VISION

SICK
Sensor Intelligence.



Illustration may differ



Ordering information

Type	part no.
VSPM-6B2113	1064565

Other models and accessories → www.sick.com/Inspector

Detailed technical data

Features

Technology	2D snapshot
Configurable	✓
Toolkit	Object Locator Pixel Counter Edge Pixel Counter Pattern Blob Finder Polygon Edge Circle Distance Angle Edge counter Find maximum
Image sensor	CMOS monochrome
Optical focus	Adjustable focus (manual)
Calibration	Perspective and lens distortion correction, mm results
Robot coordinate alignment	✓
Working range	≥ 50 mm
Operating distance with internal illumination	50 mm ... 200 mm
Field of view of internal illumination	Free of choice by lens selection
Illumination	Integrated
Illumination color	White
LED class	Risk group 1 (low risk, IEC62471 : 2006)
Spectral range	Approx. 400 nm ... 750 nm
Offline support	Emulator
Lens	S-mount

	Optical format	1/3"
	Note	To be ordered separately as accessories
Task		Detecting - Standard objects Measuring - Dimension, contour and volume Measuring - Number Identifying - OCR Identifying - Pattern Determining position - 2D position determination

Mechanics/electronics

Supply voltage	24 V DC, $\pm 20\%$
Ripple	$< 5 V_{pp}$
Current consumption	$\leq < 450\text{ mA}$ Without output load
Enclosure rating	IP67 ¹⁾
Housing material	Aluminum
Window material	No front window included
Weight	350 g
Dimensions (L x W x H)	100 mm x 53 mm x 38 mm

¹⁾ With front window mounted.

Performance

Sensor properties	
	Sensor resolution
	640 px x 480 px (0.3 MP)
Scan/frame rate	40 fps ¹⁾
Number of inspections	64
Reference images	32 objects

¹⁾ Max. 200 fps.

Interfaces

Ethernet	✓ , TCP/IP
	Data transmission rate
	100 Mbit/s
EtherNet/IP™	✓
	Data transmission rate
	100 Mbit/s
Operator interfaces	Web server
Configuration software	SOPAS ET
Data storage and retrieval	Log for 30 images, record images on PC, store images to FTP
Ethernet communication	Web API
Digital input	4 inputs (24 V)
Configurable inputs	External trigger, encoder input, External teach, reference object selection
Digital output	3 digital outputs, 24 V (B-type)
Configurable outputs	Output by logical expressions, Additional image storage possibility via FTP
Output current	$\leq 100\text{ mA}$
Standard outputs	No object detected, Everything OK, Detail error
Maximum encoder frequency	Max. 40 kHz
External illumination	5 V TTL

I/O box extension	5 x inputs for object selection, 16 outputs
--------------------------	---------------------------------------------

Ambient data

Shock load	EN 60068-2-27
Vibration load	IEC 60068-2-6
Ambient operating temperature	0 °C ... +45 °C ¹⁾
Storage temperature	-20 °C ... +70 °C ¹⁾

¹⁾ Relative humidity: 35% ... 85%, 95% in storage.

Certificates

EU declaration of conformity	✓
ACMA declaration of conformity	✓
China RoHS	✓
cULus certificate	✓
Information according to Art. 3 of Data Act (Regulation EU 2023/2854)	✓

Classifications

ECLASS 5.0	27310205
ECLASS 5.1.4	27310205
ECLASS 6.0	27310205
ECLASS 6.2	27310205
ECLASS 7.0	27310205
ECLASS 8.0	27310205
ECLASS 8.1	27310205
ECLASS 9.0	27310205
ECLASS 10.0	27310205
ECLASS 11.0	27310205
ECLASS 12.0	27310205
ETIM 5.0	EC001820
ETIM 6.0	EC001820
ETIM 7.0	EC001820
ETIM 8.0	EC001820
UNSPSC 16.0901	43211731

Dimensional drawing Standard

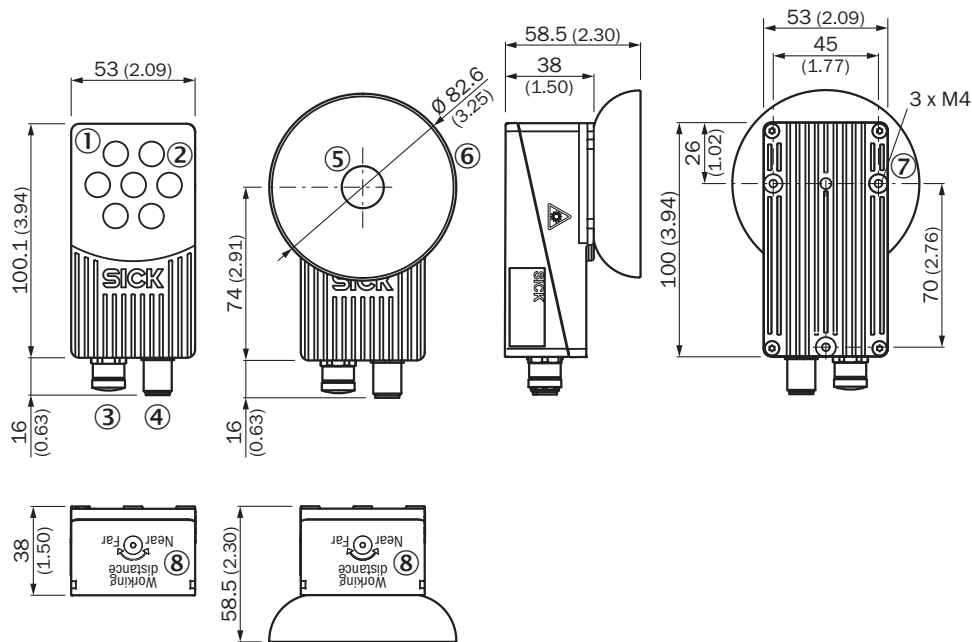

Dimensions in mm (inch)

- ① Front screen: standard, flex
- ② ring lighting
- ③ Ethernet connection M12, 4-pin, female
- ④ Power connection M12, 12-pin, male
- ⑤ Front screen: dome
- ⑥ dome light
- ⑦ Mounting hole M4
- ⑧ focus

Field of view

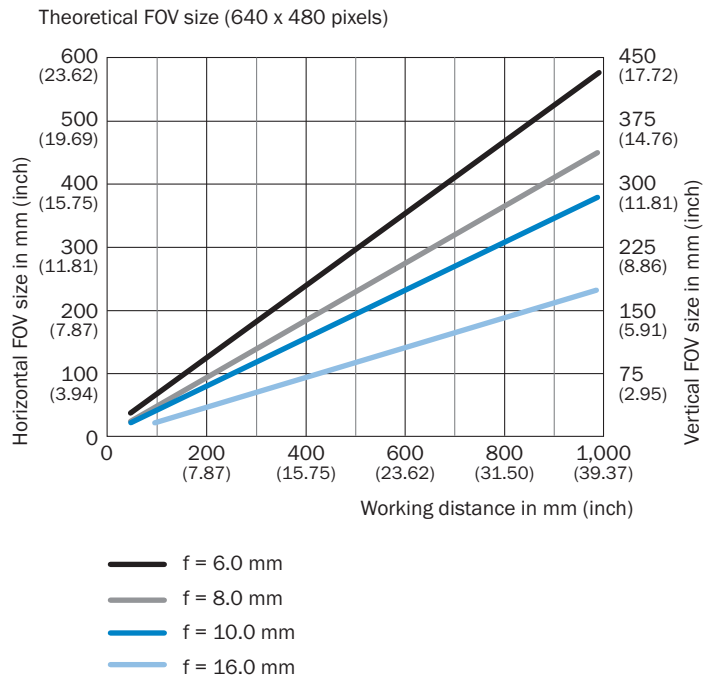

Connection type

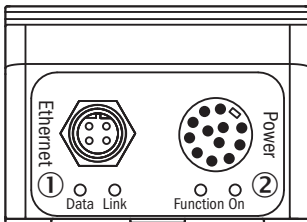

- ① Ethernet connection M12, 4-pin, female
- ② Power connection M12, 12-pin, male

Ethernet connection diagram

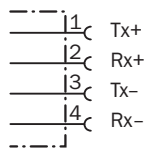



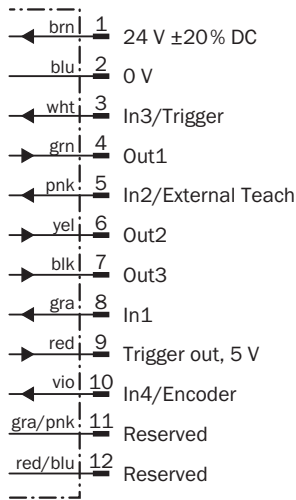

M12 connection diagram, 12-pin



Recommended accessories

Other models and accessories → www.sick.com/Inspector

	Brief description	Type	part no.
reflectors and optics			
	<ul style="list-style-type: none"> Description: Exchangeable lens, focal length 16 mm, including spacer ring 	OBJ-B16018BA	2049418
	<ul style="list-style-type: none"> Description: Exchangeable lens, focal length 6 mm 	OBJ-B06025BA	2049668
	<ul style="list-style-type: none"> Description: Exchangeable lens, focal distance 10 mm, with spacer ring 	OBJ-B10028BA	2049415
connectors and cables			
	<ul style="list-style-type: none"> Connection type head A: Male connector, M12, 4-pin, straight, D-coded Connection type head B: Male connector, RJ45, 4-pin, straight Signal type: Ethernet, PROFINET Cable: 2 m, 4-wire, PUR, halogen-free Description: Ethernet, shielded, PROFINET Application: Drag chain operation, Zones with oils and lubricants 	YM2D24-020P-N1MRJA4	2106182
	<ul style="list-style-type: none"> Description: Sensor/actuator cable, shielded Connection type head A: Female connector, M12, 12-pin, straight, A-coded Connection type head B: Flying leads Signal type: Sensor/actuator cable Cable: 5 m, 12-wire, PUR, halogen-free Application: Drag chain operation, Zones with oils and lubricants, Robot, Drag chain operation 	YF2A2B-050UD2XLEAX	2130999

SICK AT A GLANCE

SICK is one of the leading manufacturers of intelligent sensors and sensor solutions for industrial applications. A unique range of products and services creates the perfect basis for controlling processes securely and efficiently, protecting individuals from accidents and preventing damage to the environment.

We have extensive experience in a wide range of industries and understand their processes and requirements. With intelligent sensors, we can deliver exactly what our customers need. In application centers in Europe, Asia and North America, system solutions are tested and optimized in accordance with customer specifications. All this makes us a reliable supplier and development partner.

Comprehensive services complete our offering: SICK LifeTime Services provide support throughout the machine life cycle and ensure safety and productivity.

For us, that is “Sensor Intelligence.”

WORLDWIDE PRESENCE:

Contacts and other locations –www.sick.com