



# i110-RP224

i110RP

SAFETY COMMAND DEVICES

**SICK**  
Sensor Intelligence.



### Ordering information

Type	part no.
i110-RP224	1064510

Other models and accessories → [www.sick.com/i110RP](http://www.sick.com/i110RP)



### Detailed technical data

#### Features

<b>Positive action N/C contacts</b>	2
<b>N/O contacts</b>	0
<b>Actuation force (deflection)</b>	125 N (300 mm)
<b>Actuation frequency</b>	≤ 3,600 /h
<b>Actuation directions</b>	1
<b>Cord length</b>	≤ 30 m

#### Safety-related parameters

<b>B<sub>10d</sub> parameter</b>	2 x 10 <sup>6</sup> switching cycles (with small load)
<b>Safe state in the event of a fault</b>	The switch has no internal fault detection and is unable to assume a safe state in the event of a fault. Fault detection is performed by the connected safety-related logic unit.

#### Functions

<b>Safe series connection</b>	With Flexi Loop (with diagnostics)
-------------------------------	------------------------------------

#### Interfaces

<b>Connection type</b>	Plug connector, M12, 4-pin
Coupling nut material	Nickel-plated brass

#### Electronics

<b>Switching principle</b>	Slow action switching element
<b>Positive action N/C contacts</b>	2
<b>N/O contacts</b>	0
<b>Usage category</b>	DC-13 (IEC 60947-5-1)
<b>Rated operating current (voltage)</b>	2 A (24 V DC)
<b>Rated insulation voltage U<sub>i</sub></b>	32 V
<b>Rated impulse withstand voltage U<sub>imp</sub></b>	1,500 V
<b>Short-circuit protection</b>	2 A
<b>Switching voltage</b>	≥ 5 V DC

<b>Switching current (switching voltage)</b>	5 mA (5 V DC)
--	---------------

### Mechanics

<b>Dimensions</b>	40 mm x 204 mm x 56 mm
<b>Weight</b>	+ 0.84 kg
<b>Housing material</b>	Zinc diecast
<b>Surface treatment</b>	Varnished
<b>Mechanical life</b>	1 x 10 <sup>6</sup> switching cycles

### Ambient data

<b>Enclosure rating</b>	IP66 (IEC 60529)
<b>Ambient operating temperature</b>	-25 °C ... +80 °C
<b>Storage temperature</b>	-25 °C ... +80 °C

### Certificates

<b>EU declaration of conformity</b>	✓
<b>UK declaration of conformity</b>	✓
<b>China RoHS</b>	✓
<b>cULus certificate</b>	✓

### Classifications

<b>ECLASS 5.0</b>	27270601
<b>ECLASS 5.1.4</b>	27270690
<b>ECLASS 6.0</b>	27270607
<b>ECLASS 6.2</b>	27270607
<b>ECLASS 7.0</b>	27270607
<b>ECLASS 8.0</b>	27270607
<b>ECLASS 8.1</b>	27270607
<b>ECLASS 9.0</b>	27270607
<b>ECLASS 10.0</b>	27270607
<b>ECLASS 11.0</b>	27270607
<b>ECLASS 12.0</b>	27270607
<b>ETIM 5.0</b>	EC002033
<b>ETIM 6.0</b>	EC002033
<b>ETIM 7.0</b>	EC002033
<b>ETIM 8.0</b>	EC002033
<b>UNSPSC 16.0901</b>	39121545

Dimensional drawing

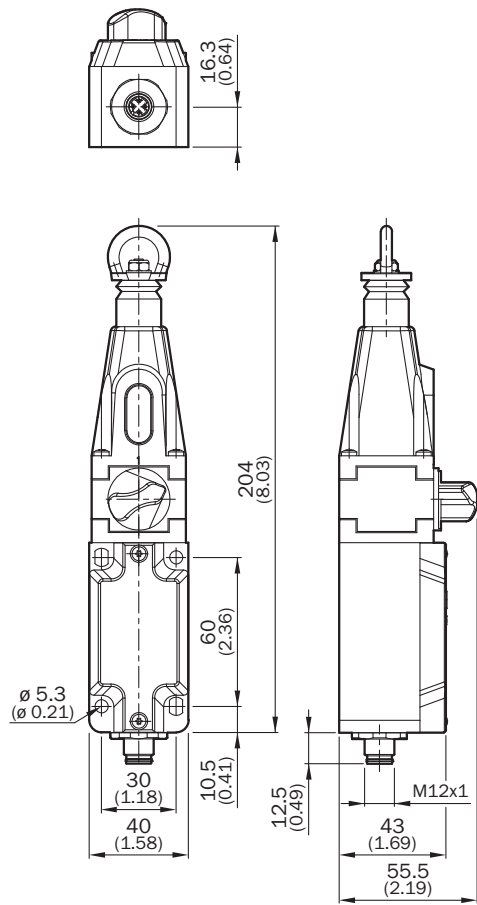

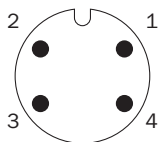

Dimensions in mm (inch)

Pinouts



1	positive action N/C contacts 11/12
2	positive action N/C contacts 21/22
3	positive action N/C contacts 11/12
4	positive action N/C contacts 21/22

## Switching elements

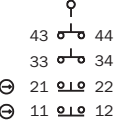
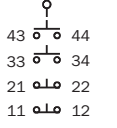
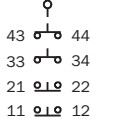
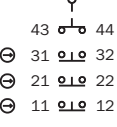
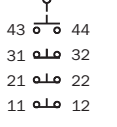
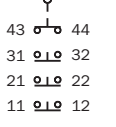
	Rope stack	Rope tensioned	Rope pulled
			
Switching element 22			
Switching element 31			

### Switching element 22:

2 positive action N/C contacts + 2 N/O contact

### Switching element 31:

3 positive action N/C contacts + 1 N/O contact

## SICK AT A GLANCE

SICK is one of the leading manufacturers of intelligent sensors and sensor solutions for industrial applications. A unique range of products and services creates the perfect basis for controlling processes securely and efficiently, protecting individuals from accidents and preventing damage to the environment.

We have extensive experience in a wide range of industries and understand their processes and requirements. With intelligent sensors, we can deliver exactly what our customers need. In application centers in Europe, Asia and North America, system solutions are tested and optimized in accordance with customer specifications. All this makes us a reliable supplier and development partner.

Comprehensive services complete our offering: SICK LifeTime Services provide support throughout the machine life cycle and ensure safety and productivity.

For us, that is “Sensor Intelligence.”

## WORLDWIDE PRESENCE:

Contacts and other locations –[www.sick.com](http://www.sick.com)