



GRL18S-N1356

GR18

PHOTOELECTRIC SENSORS

SICK
Sensor Intelligence.



Illustration may differ



Ordering information

Type	part no.
GRL18S-N1356	1064144

Included in delivery: P250 (1)

Other models and accessories → www.sick.com/GR18

Detailed technical data

Features

Functional principle	Photoelectric retro-reflective sensor
Functional principle detail	With minimum distance to reflector (dual lens system)
Dimensions (W x H x D)	18 mm x 18 mm x 38.1 mm
Housing design (light emission)	Cylindrical
Thread diameter (housing)	M18 x 1
Optical axis	Axial
Sensing range max.	0.03 m ... 7.2 m ¹⁾
Sensing range	0.06 m ... 6 m ¹⁾
Type of light	Visible red light
Light source	PinPoint LED ²⁾
Light spot size (distance)	Ø 175 mm (7 m)
Wave length	650 nm
Adjustment	None
Display	
	LED green Operating indicator Static on: power on
	LED yellow Status of received light beam Static on: object not present Static off: object present

¹⁾ Reflector PL80A.

²⁾ Average service life: 100,000 h at T_U = +25 °C.

Mechanics/electronics

Supply voltage U_B	10 V DC ... 30 V DC ¹⁾
Ripple	< 5 V _{pp} ²⁾
Current consumption	30 mA
Switching output	NPN
Switching mode	Light switching
Signal voltage NPN HIGH/LOW	Approx. $V_S / \leq 3$ V
Output current I_{max}	≤ 100 mA ³⁾
Response time	< 500 μ s ⁴⁾
Switching frequency	1,000 Hz ⁵⁾
Connection type	Cable, 3-wire, 2 m ⁶⁾
Cable material	Plastic, PVC
Circuit protection	A ⁷⁾ B ⁸⁾ D ⁹⁾
Protection class	III
Polarisation filter	✓
Housing material	Plastic, ABS
Optics material	Plastic, PMMA
Enclosure rating	IP67
Items supplied	Fastening nuts (2 x), Reflector P250
Electromagnetic compatibility (EMC)	EN 60947-5-2
Ambient operating temperature	-25 °C ... +55 °C ¹⁰⁾
Ambient temperature, storage	-40 °C ... +70 °C
UL File No.	NRKH.E348498 & NRKH7.E348498

¹⁾ Limit values. Operated in short-circuit protected network: max. 8 A.

²⁾ May not fall below or exceed U_V tolerances.

³⁾ At $U_V > 24$ V or ambient temperature > 49 °C, I_A max. = 50 mA.

⁴⁾ Signal transit time with resistive load.

⁵⁾ With light/dark ratio 1:1.

⁶⁾ Do not bend below 0 °C.

⁷⁾ A = V_S connections reverse-polarity protected.

⁸⁾ B = inputs and output reverse-polarity protected.

⁹⁾ D = outputs overcurrent and short-circuit protected.

¹⁰⁾ At $U_V \leq 24$ V and $I_A < 50$ mA.

Certificates

EU declaration of conformity	✓
UK declaration of conformity	✓
ACMA declaration of conformity	✓
Moroccan declaration of conformity	✓
China RoHS	✓
ECOLAB certificate	✓
cULus certificate	✓

Photobiological safety (DIN EN 62471) certificate

✓

Classifications

ECLASS 5.0	27270902
ECLASS 5.1.4	27270902
ECLASS 6.0	27270902
ECLASS 6.2	27270902
ECLASS 7.0	27270902
ECLASS 8.0	27270902
ECLASS 8.1	27270902
ECLASS 9.0	27270902
ECLASS 10.0	27270902
ECLASS 11.0	27270902
ECLASS 12.0	27270902
ETIM 5.0	EC002717
ETIM 6.0	EC002717
ETIM 7.0	EC002717
ETIM 8.0	EC002717
UNSPSC 16.0901	39121528

Connection type

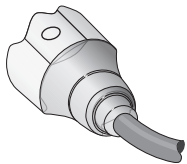

Connection diagram Cd-044

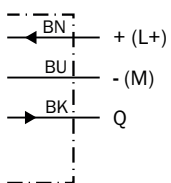

Characteristic curve GRL18S



- ① Reflector PL80A
- ② Reflector PL40A
- ③ Reflector PL20A
- ④ Reflector P250
- ⑤ Reflector PL22
- ⑥ Reflective tape REF-Plus 3436

Light spot size GRL18S

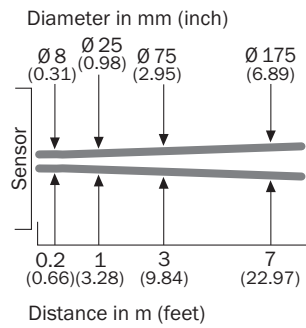

Sensing range diagram GRL18S

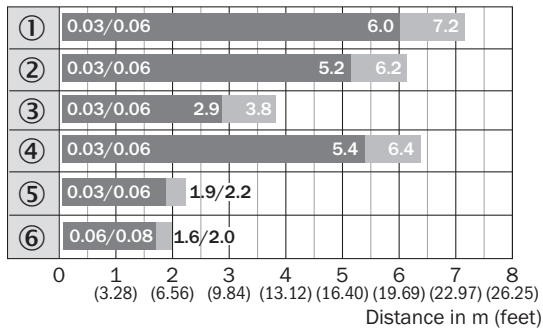

- ① Reflector PL80A
- ② Reflector PL40A
- ③ Reflector PL20A
- ④ Reflector P250
- ⑤ Reflector PL22
- ⑥ Reflective tape REF-Plus 3436

Response range GRL18S

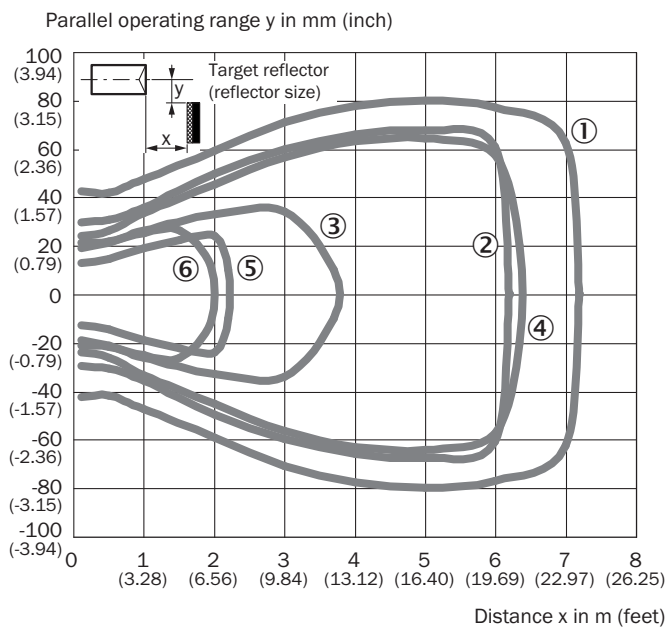

Dimensional drawing GR18S, plastic, cable, straight

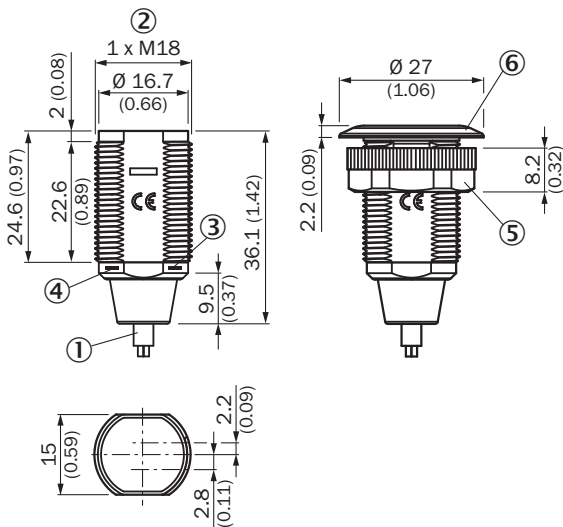



Dimensions in mm (inch)

- ① Connection cable 2 m
- ② Threaded mounting hole M18 x 1
- ③ LED indicator yellow
- ④ LED indicator green
- ⑤ fastening nut; 22 mm hex, plastic
- ⑥ Mounting ring

Recommended accessories

Other models and accessories → www.sick.com/GR18

	Brief description	Type	part no.
Mounting systems			
	<ul style="list-style-type: none"> • Description: Mounting bracket for M18 sensors • Material: Steel • Details: Steel, zinc coated • Items supplied: Without mounting hardware • Suitable for: GR18, V180-2, V18, W15, Z1, Z2 	BEF-WN-M18	5308446
	<ul style="list-style-type: none"> • Description: Universal mounting bracket for reflectors • Dimensions (W x H x L): 85 mm x 90 mm x 35 mm • Material: Steel • Details: Steel, zinc coated • Suitable for: C110A, P250, PL20, PL30A, PL40A, PL80A 	BEF-WN-REFX	2064574
reflectors and optics			
	<ul style="list-style-type: none"> • Description: Rectangular, screw connection • Dimensions: 51 mm 61 mm • Ambient operating temperature: -30 °C ... +65 °C 	P250	5304812

	Brief description	Type	part no.
connectors and cables			
	<ul style="list-style-type: none">• Description: Unshielded• Connection type head A: Male connector, M8, 3-pin, straight, A-coded• Connection systems: Screw-type terminals• Permitted cross-section: 0.14 mm² ... 0.5 mm²	STE-0803-G	6037322

SICK AT A GLANCE

SICK is one of the leading manufacturers of intelligent sensors and sensor solutions for industrial applications. A unique range of products and services creates the perfect basis for controlling processes securely and efficiently, protecting individuals from accidents and preventing damage to the environment.

We have extensive experience in a wide range of industries and understand their processes and requirements. With intelligent sensors, we can deliver exactly what our customers need. In application centers in Europe, Asia and North America, system solutions are tested and optimized in accordance with customer specifications. All this makes us a reliable supplier and development partner.

Comprehensive services complete our offering: SICK LifeTime Services provide support throughout the machine life cycle and ensure safety and productivity.

For us, that is “Sensor Intelligence.”

WORLDWIDE PRESENCE:

Contacts and other locations –www.sick.com