

CLV630-0120F0

CLV63x

FIXED MOUNT BARCODE SCANNERS

SICK
Sensor Intelligence.



Ordering information

Type	part no.
CLV630-0120F0	1063470

Other models and accessories → www.sick.com/CLV63x



Detailed technical data

Features

Version	Long Range
Connection type	Ethernet
Reading field	Front
Sensor type	Line scanner
Optical focus	Fixed focus
Light source	Light spot, laser, Visible, Red, 655 nm
Light spot	Circular
Laser class	2, complies with 21 CFR 1040.10 except for the conformance according to "Laser Notice No. 56" from May 8, 2019 (EN 60825-1:2014+A11:2021, IEC 60825-1:2014)
Aperture angle	≤ 50°
Reading distance	60 mm ... 735 mm ¹⁾
Scanning frequency	400 Hz ... 1,200 Hz
Code resolution	0.35 mm ... 1 mm
Heating	✓
Cold storage applications	✓

¹⁾ For details see reading field diagram.

Mechanics/electronics

Connection type	2 x M12 cylindrical connectors (12-pin male connector, 4-pin female connector) on swivel connector 1 x cable, open-ended, 3-wire (2 m)
Supply voltage	≤ 24 V DC, ± 10 %
Power consumption	40 W
Housing material	Aluminum die cast
Housing color	Light blue (RAL 5012)
Window material	Glass
Enclosure rating	IP65 (EN 60529)
Protection class	III (EN 61140)
Weight	450 g, without connecting cable
Dimensions (L x W x H)	61 mm x 96 mm x 50 mm ¹⁾
MTBF	100,000 h
MTTF	40,000 h (Laser diode) ²⁾

¹⁾ Swivel connector is 15 mm longer.

²⁾ At 25 °C.

Performance

Readable code structures	1D codes
Bar code types	All current code types, Code 39, Code 128, Code 93, Codabar, GS1-128 / EAN 128, UPC / GTIN / EAN, Interleaved 2 of 5, Pharmacode, GS1 DataBar, Telepen, MSI/Plessey
Code printing process	Label (printed codes)
Print ratio	2:1 ... 3:1
No. of codes per scan	1 ... 20 (Standard decoder) 1 ... 6 (SMART decoder)
No. of codes per reading interval	1 ... 50 (auto-discriminating)
No. of characters per reading interval	5,000 500 (for multiplexer function in CAN operation)
No. of multiple readings	1 ... 99

Interfaces

Ethernet	Function	✓, TCP/IP
	Data transmission rate	Data interface (read result output), Service interface 10/100 MBit/s
PROFINET	Function	✓ PROFINET Single Port, PROFINET Dual Port (optional via external connection module CDF600-2)
	Data transmission rate	10/100 MBit/s
EtherNet/IP™	Function	✓
	Data transmission rate	10/100 MBit/s
EtherCAT®	Function	✓
	Type of fieldbus integration	Optional over external fieldbus module CDF600
Serial	Function	✓, RS-232, RS-422, RS-485
	Data transmission rate	Data interface (read result output), Service interface 2,400 Baud ... 115.2 kBaud, AUX: 57.6 kBaud (RS-232)

CAN	✓
Function	SICK CAN sensor network CSN (CAN controller/CAN device, multiplexer/server)
Data transmission rate	20 kbit/s ... 1 Mbit/s
CANopen	✓
Data transmission rate	20 kbit/s ... 1 Mbit/s
PROFIBUS DP	✓
Type of fieldbus integration	Optional over external fieldbus module CDF600-2
Digital inputs	3 ("Sensor 1", 2 inputs via optional parameter storage CMC600 in CDB620/CDM420)
Digital outputs	2 (Via optional CMC600 parameter memory in CDB620/CDM420)
Reading pulse	Digital inputs, non-powered, serial interface, auto pulse, CAN
Optical indicators	6 LEDs (Ready, Result, laser, Data, CAN, LNK TX, Bar graph for displaying the reading rate percentage (10 LEDs))
Acoustic indicators	Beeper/buzzer (can be switched off, can be allocated as a result indication function)
Control elements	2 buttons (choose and start/stop functions)
Configuration software	SOPAS ET
Memory card	MicroSD memory card (flash card), optional

Ambient data

Electromagnetic compatibility (EMC)	EN 61000-6-3 (2001-10) / EN 61000-6-2:2005
Vibration resistance	EN 60068-2-6 (1995)
Shock resistance	EN 60068-2-27 (1993)
Ambient operating temperature	-35 °C ... +35 °C
Storage temperature	-20 °C ... +70 °C
Relative humidity	90 %, Non-condensing
Ambient light immunity	2,000 lx, on barcode
Bar code print contrast (PCS)	≥ 60 %

Certificates

EU declaration of conformity	✓
UK declaration of conformity	✓
ACMA declaration of conformity	✓
China RoHS	✓
cULus certificate	✓
Ethercat certificate	✓
Profinet certificate	✓
Laser safety (IEC 60825-1) declaration of manufacturer	✓
Information according to Art. 3 of Data Act (Regulation EU 2023/2854)	✓
4Dpro	✓

Classifications

ECLASS 5.0	27280102
ECLASS 5.1.4	27280102
ECLASS 6.0	27280102

ECLASS 6.2	27280102
ECLASS 7.0	27280102
ECLASS 8.0	27280102
ECLASS 8.1	27280102
ECLASS 9.0	27280102
ECLASS 10.0	27280102
ECLASS 11.0	27280102
ECLASS 12.0	27280102
ETIM 5.0	EC002550
ETIM 6.0	EC002550
ETIM 7.0	EC002550
ETIM 8.0	EC002550
UNSPSC 16.0901	43211701

Dimensional drawing

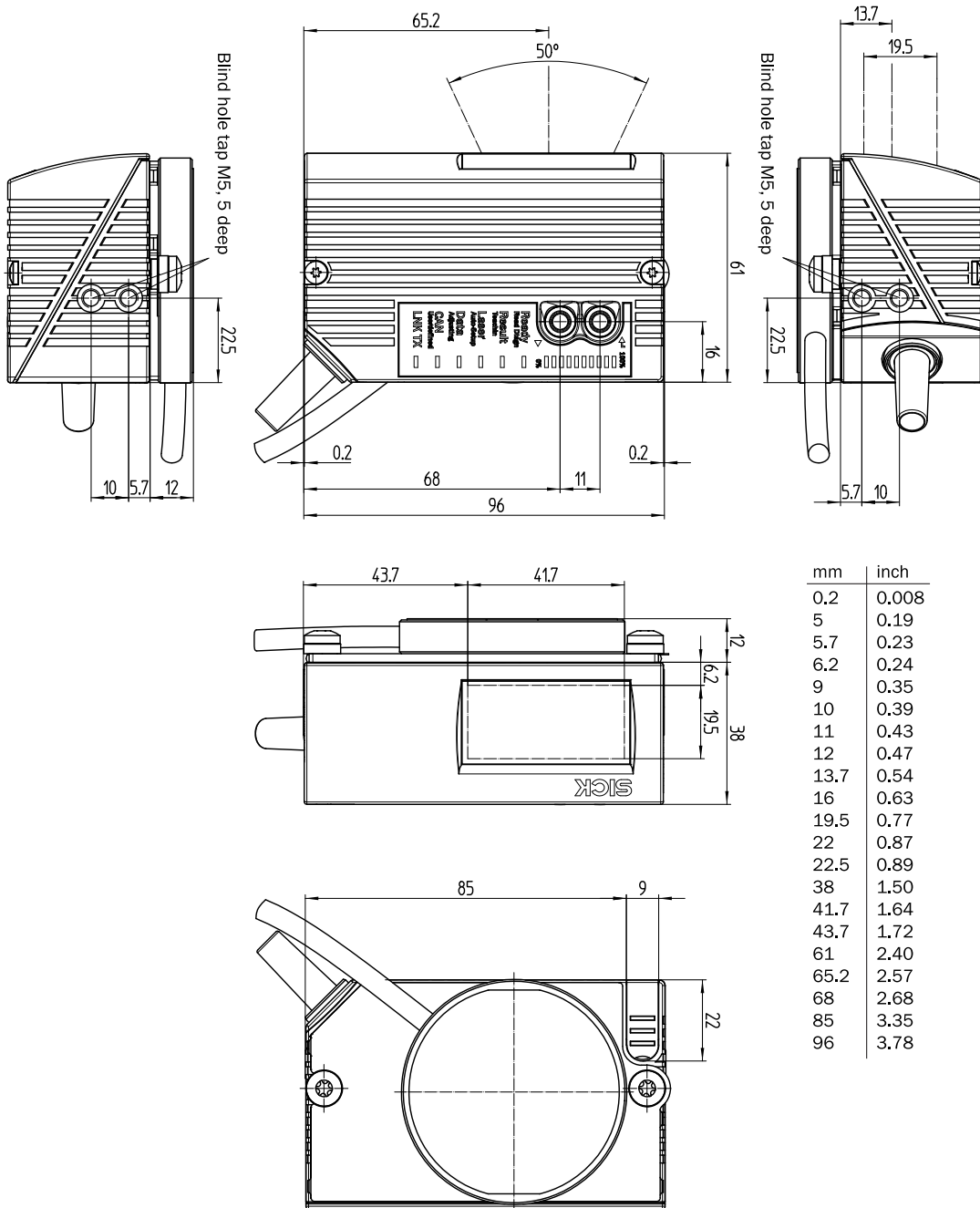

Dimensions in mm (inch)

Reading field diagram

Reading field height in mm (inch)

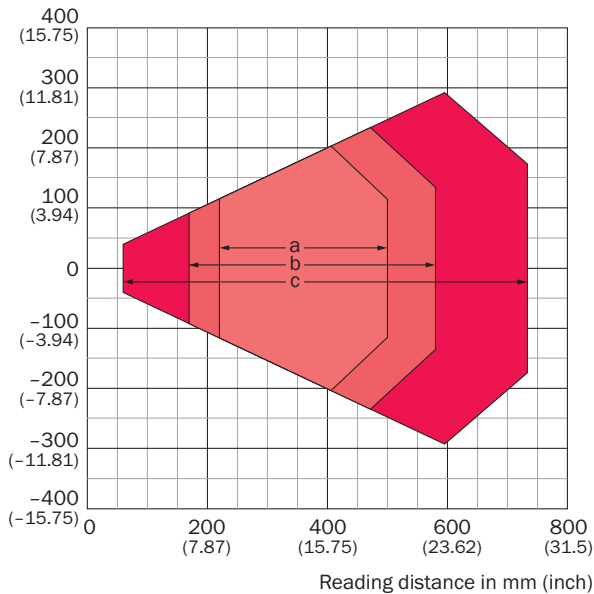





For devices with plastic reading window, the depth of field is reduced by approx. 10 %.



Resolution

- a: 0.35 mm (13.8 mil)
- b: 0.50 mm (19.7 mil)
- c: 1.0 mm (39.4 mil)

Recommended accessories

Other models and accessories → www.sick.com/CLV63x

	Brief description	Type	part no.
Junction boxes			
		CDB620-001	1042256
		CDM420-0001	1025362
Mounting systems			
	<ul style="list-style-type: none"> Description: Hanger-shaped mounting bracket, thermally isolated for use with heating devices Items supplied: Mounting hardware included 	Mounting bracket	2050705
connectors and cables			
	<ul style="list-style-type: none"> Connection type head A: Male connector, M12, 4-pin, straight, D-coded Connection type head B: Male connector, RJ45, 8-pin, straight Signal type: Ethernet, PROFINET Cable: 2 m, 4-wire, AWG26, PVC Description: Ethernet, shielded, PROFINET 	YM2D24-020E-B2MRJA4	6050198

	Brief description	Type	part no.
device protection and care			
	<ul style="list-style-type: none"> • Product family: Heating devices • Description: Additional board for connecting a bar code scanner with heater in combination with CDM-420 	Additional board	2055071
integration modules and adapters			
	<ul style="list-style-type: none"> • Description: External parameter memory for integration in CDB620/CDB650/CDM42x 	CMC600-101	1042259
Storage media			
	<ul style="list-style-type: none"> • Description: microSD memory card with 1 GB for industrial use 	microSD memory card	4051366

SICK AT A GLANCE

SICK is one of the leading manufacturers of intelligent sensors and sensor solutions for industrial applications. A unique range of products and services creates the perfect basis for controlling processes securely and efficiently, protecting individuals from accidents and preventing damage to the environment.

We have extensive experience in a wide range of industries and understand their processes and requirements. With intelligent sensors, we can deliver exactly what our customers need. In application centers in Europe, Asia and North America, system solutions are tested and optimized in accordance with customer specifications. All this makes us a reliable supplier and development partner.

Comprehensive services complete our offering: SICK LifeTime Services provide support throughout the machine life cycle and ensure safety and productivity.

For us, that is “Sensor Intelligence.”

WORLDWIDE PRESENCE:

Contacts and other locations –www.sick.com