



# RTQ-B1221

ZoneControl

PHOTOELECTRIC SENSORS

**SICK**  
Sensor Intelligence.



Illustration may differ



### Ordering information

Type	part no.
RTQ-B1221	1063177

Other models and accessories → [www.sick.com/ZoneControl](http://www.sick.com/ZoneControl)

### Detailed technical data

#### Features

<b>Functional principle</b>	Photoelectric proximity sensor
<b>Functional principle detail</b>	Background suppression
<b>Dimensions (W x H x D)</b>	20.6 mm x 99.2 mm x 48.9 mm
<b>Sensing range max.</b>	60 mm ... 900 mm
<b>Sensing range</b>	60 mm ... 900 mm
<b>Focus</b>	7°
<b>Type of light</b>	Infrared light
<b>Light source</b>	LED <sup>1)</sup>
<b>Light spot size (distance)</b>	Ø 20 mm (500 mm)
<b>Angle of dispersion</b>	7°
<b>Adjustment</b>	Potentiometer, 9 turns
<b>Special applications</b>	ZoneControl

<sup>1)</sup> Average service life: 100,000 h at T<sub>U</sub> = +25 °C.

#### Mechanics/electronics

<b>Supply voltage U<sub>B</sub></b>	10 V DC ... 30 V DC <sup>1)</sup>
<b>Ripple</b>	< 5 V <sub>pp</sub> <sup>2)</sup>
<b>Current consumption</b>	20 mA <sup>3)</sup>
<b>Switching output</b>	PNP <sup>4)</sup> NPN

<sup>1)</sup> Limit values.

<sup>2)</sup> May not fall below or exceed U<sub>V</sub> tolerances.

<sup>3)</sup> Without load and valve deenergized.

<sup>4)</sup> Selectable via light/dark rotary switch.

<sup>5)</sup> A = V<sub>S</sub> connections reverse-polarity protected.

<sup>6)</sup> C = interference suppression.

<sup>7)</sup> D = outputs overcurrent and short-circuit protected.

<b>Switching mode</b>	Light/dark switching <sup>4)</sup>
<b>Signal voltage PNP HIGH/LOW</b>	Approx. $V_S - 0.5 \text{ V} / 0 \text{ V}$
<b>Signal voltage NPN HIGH/LOW</b>	Approx. $V_S / < 2.0 \text{ V}$
<b>Output current <math>I_{\text{max}}</math></b>	$\leq 100 \text{ mA}$
<b>Response time</b>	2 ms
<b>Switching frequency</b>	250 Hz
<b>Connection type</b>	Male connector M12, 4-pin
<b>Circuit protection</b>	A <sup>5)</sup> C <sup>6)</sup> D <sup>7)</sup>
<b>Protection class</b>	III
<b>Weight</b>	175 g
<b>Housing material</b>	Plastic, ABS
<b>Enclosure rating</b>	IP67
<b>Shock and vibration resistance</b>	According to IEC 68
<b>Ambient operating temperature</b>	-40 °C ... +60 °C
<b>Ambient temperature, storage</b>	-40 °C ... +75 °C
<b>UL File No.</b>	NRKH.E189383 & NRKH7.E189383

<sup>1)</sup> Limit values.

<sup>2)</sup> May not fall below or exceed  $U_V$  tolerances.

<sup>3)</sup> Without load and valve deenergized.

<sup>4)</sup> Selectable via light/dark rotary switch.

<sup>5)</sup> A =  $V_S$  connections reverse-polarity protected.

<sup>6)</sup> C = interference suppression.

<sup>7)</sup> D = outputs overcurrent and short-circuit protected.

### Safety-related parameters

<b>MTTF<sub>D</sub></b>	1,009 years
<b>DC<sub>avg</sub></b>	0 %

### Certificates

<b>EU declaration of conformity</b>	✓
<b>China RoHS</b>	✓

### Classifications

<b>ECLASS 5.0</b>	27270904
<b>ECLASS 5.1.4</b>	27270904
<b>ECLASS 6.0</b>	27270904
<b>ECLASS 6.2</b>	27270904
<b>ECLASS 7.0</b>	27270904
<b>ECLASS 8.0</b>	27270904
<b>ECLASS 8.1</b>	27270904
<b>ECLASS 9.0</b>	27270904
<b>ECLASS 10.0</b>	27270904
<b>ECLASS 11.0</b>	27270904

<b>ECLASS 12.0</b>	27270903
<b>ETIM 5.0</b>	EC002719
<b>ETIM 6.0</b>	EC002719
<b>ETIM 7.0</b>	EC002719
<b>ETIM 8.0</b>	EC002719
<b>UNSPSC 16.0901</b>	39121528

### Connection diagram Cd-256

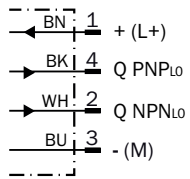

### Characteristic curve

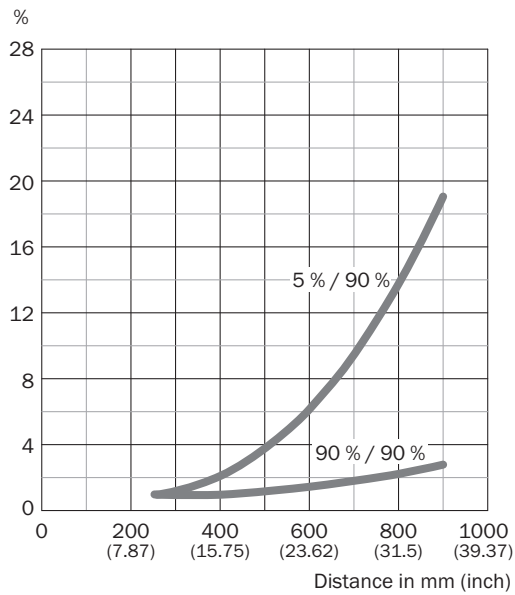

### Light spot size

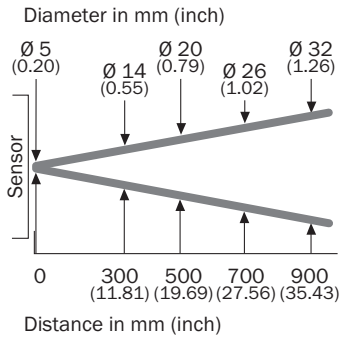



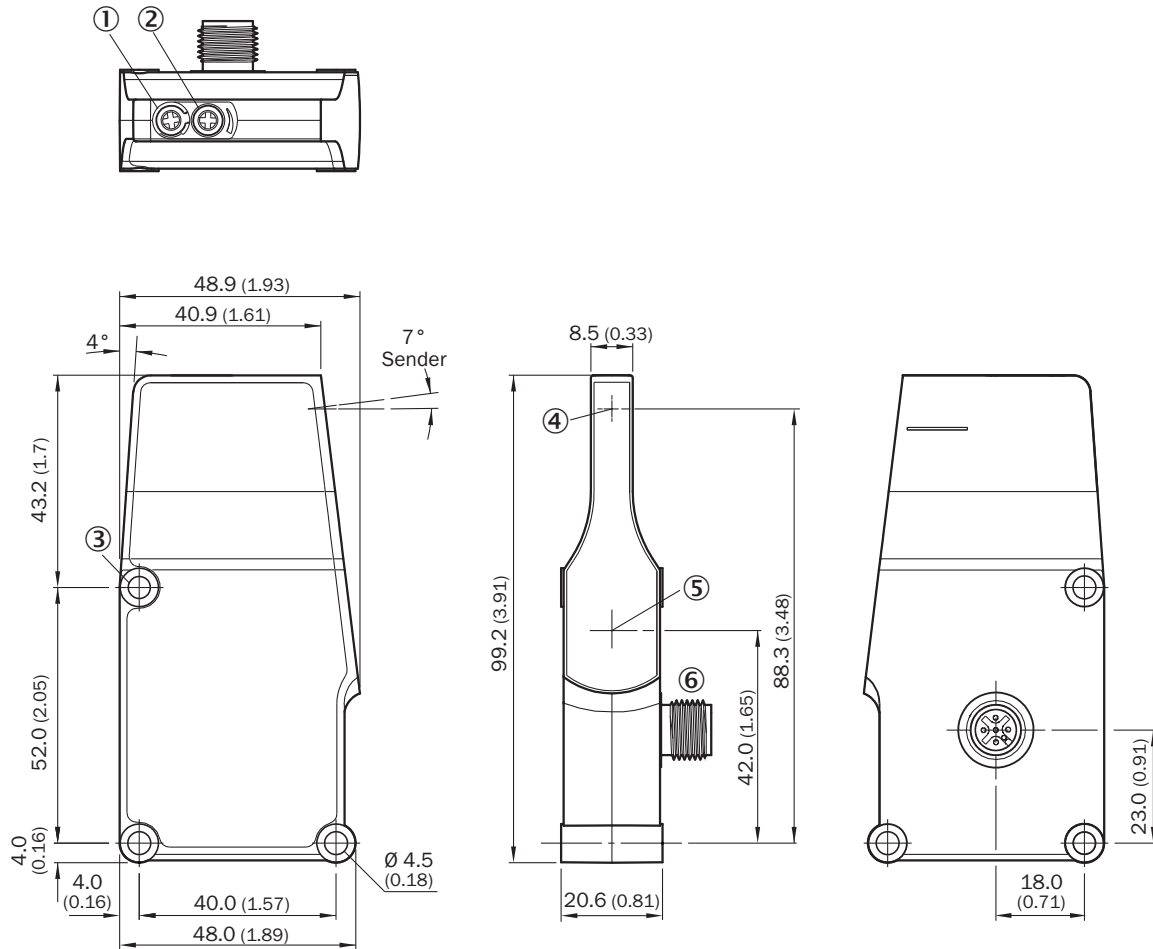

### Dimensional drawing R / IR without valve



- Dimensions in mm (inch)
- ① LED
  - ② Potentiometer
  - ③ fixing hole
  - ④ Center of optical axis, sender
  - ⑤ Center of optical axis, receiver
  - ⑥ male connector M12, 4-pin

### Recommended accessories

Other models and accessories → [www.sick.com/ZoneControl](http://www.sick.com/ZoneControl)

	Brief description	Type	part no.
connectors and cables			
	<ul style="list-style-type: none"> <li><b>Description:</b> Sensor/actuator cable, unshielded</li> <li><b>Connection type head A:</b> Female connector, M12, 4-pin, straight, A-coded</li> <li><b>Connection type head B:</b> Flying leads</li> <li><b>Signal type:</b> Sensor/actuator cable</li> <li><b>Cable:</b> 5 m, 4-wire, PVC</li> <li><b>Application:</b> Uncontaminated zones, Zones with chemicals</li> </ul>	YF2A14-050VB3XLEAX	2096235
	<ul style="list-style-type: none"> <li><b>Description:</b> Unshielded</li> <li><b>Connection type head A:</b> Male connector, M12, 4-pin, straight, A-coded</li> <li><b>Connection systems:</b> Screw-type terminals</li> <li><b>Permitted cross-section:</b> ≤ 0.75 mm<sup>2</sup></li> </ul>	STE-1204-G	6009932
Mounting systems			
	<ul style="list-style-type: none"> <li><b>Description:</b> Mounting bracket</li> <li><b>Material:</b> Steel</li> <li><b>Details:</b> Steel, zinc coated</li> <li><b>Items supplied:</b> Mounting hardware included</li> </ul>	BEF-WN-RT/IRT	2074621
	<ul style="list-style-type: none"> <li><b>Description:</b> Mounting bracket</li> <li><b>Material:</b> Steel</li> <li><b>Details:</b> Steel, zinc coated</li> <li><b>Items supplied:</b> Mounting hardware included</li> <li><b>Usable for:</b> WTR/WLR, IRT</li> </ul>	BEF-WK-WTR	2051786

## SICK AT A GLANCE

SICK is one of the leading manufacturers of intelligent sensors and sensor solutions for industrial applications. A unique range of products and services creates the perfect basis for controlling processes securely and efficiently, protecting individuals from accidents and preventing damage to the environment.

We have extensive experience in a wide range of industries and understand their processes and requirements. With intelligent sensors, we can deliver exactly what our customers need. In application centers in Europe, Asia and North America, system solutions are tested and optimized in accordance with customer specifications. All this makes us a reliable supplier and development partner.

Comprehensive services complete our offering: SICK LifeTime Services provide support throughout the machine life cycle and ensure safety and productivity.

For us, that is “Sensor Intelligence.”

## WORLDWIDE PRESENCE:

Contacts and other locations –[www.sick.com](http://www.sick.com)