



# VSPM-6F2413

Inspector

2D MACHINE VISION

**SICK**  
Sensor Intelligence.



### Ordering information

| Type        | part no. |
|-------------|----------|
| VSPM-6F2413 | 1062408  |

Other models and accessories → [www.sick.com/Inspector](http://www.sick.com/Inspector)



### Detailed technical data

#### Features

|                                                      |                                                                                                                                                                   |
|------------------------------------------------------|-------------------------------------------------------------------------------------------------------------------------------------------------------------------|
| <b>Technology</b>                                    | 2D snapshot                                                                                                                                                       |
| <b>Configurable</b>                                  | ✓                                                                                                                                                                 |
| <b>Toolkit</b>                                       | Object Locator<br>Pixel Counter<br>Edge Pixel Counter<br>Pattern<br>Blob Finder<br>Polygon<br>Edge<br>Circle<br>Distance<br>Angle<br>Edge counter<br>Find maximum |
| <b>Image sensor</b>                                  | CMOS monochrome                                                                                                                                                   |
| <b>Optical focus</b>                                 | Adjustable focus (manual)                                                                                                                                         |
| <b>Calibration</b>                                   | Perspective and lens distortion correction, mm results                                                                                                            |
| <b>Robot coordinate alignment</b>                    | ✓                                                                                                                                                                 |
| <b>Working range</b>                                 | ≥ 50 mm                                                                                                                                                           |
| <b>Operating distance with internal illumination</b> | 50 mm ... 200 mm                                                                                                                                                  |
| <b>Field of view of internal illumination</b>        | 22 mm x 15 mm ... 79 mm x 58 mm                                                                                                                                   |
| <b>Illumination</b>                                  | Integrated                                                                                                                                                        |
| <b>Illumination color</b>                            | Infrared                                                                                                                                                          |
| <b>LED class</b>                                     | Risk-free group (no danger, IEC62471: 2006)                                                                                                                       |
| <b>Spectral range</b>                                | Approx. 370 nm ... 900 nm                                                                                                                                         |
| <b>Offline support</b>                               | Emulator                                                                                                                                                          |
| <b>Lens</b>                                          | S-mount                                                                                                                                                           |
| <b>Optical format</b>                                | 1/3"                                                                                                                                                              |

|             |              |                                                                                                                                                                                                   |
|-------------|--------------|---------------------------------------------------------------------------------------------------------------------------------------------------------------------------------------------------|
|             | Focal length | 10 mm                                                                                                                                                                                             |
| <b>Task</b> |              | Detecting - Standard objects<br>Measuring - Dimension, contour and volume<br>Measuring - Number<br>Identifying - OCR<br>Identifying - Pattern<br>Determining position - 2D position determination |

### Mechanics/electronics

|                               |                                               |
|-------------------------------|-----------------------------------------------|
| <b>Supply voltage</b>         | 24 V DC, $\pm 20\%$                           |
| <b>Ripple</b>                 | $< 5 V_{pp}$                                  |
| <b>Current consumption</b>    | $\leq < 450\text{ mA}$<br>Without output load |
| <b>Enclosure rating</b>       | IP67 <sup>1)</sup>                            |
| <b>Housing material</b>       | Aluminum                                      |
| <b>Window material</b>        | PMMA                                          |
| <b>Weight</b>                 | 350 g                                         |
| <b>Dimensions (L x W x H)</b> | 100 mm x 53 mm x 38 mm                        |

<sup>1)</sup> With front window mounted.

### Performance

|                              |                   |                          |
|------------------------------|-------------------|--------------------------|
| <b>Sensor properties</b>     |                   |                          |
|                              | Sensor resolution | 640 px x 480 px (0.3 MP) |
| <b>Scan/frame rate</b>       |                   | 40 fps <sup>1)</sup>     |
| <b>Number of inspections</b> |                   | 64                       |
| <b>Reference images</b>      |                   | 32 objects               |

<sup>1)</sup> Max. 200 fps.

### Interfaces

|                                   |                        |                                                                             |
|-----------------------------------|------------------------|-----------------------------------------------------------------------------|
| <b>Ethernet</b>                   |                        | ✓, TCP/IP                                                                   |
|                                   | Data transmission rate | 100 Mbit/s                                                                  |
| <b>EtherNet/IP™</b>               |                        | ✓                                                                           |
|                                   | Data transmission rate | 100 Mbit/s                                                                  |
| <b>Operator interfaces</b>        |                        | Web server                                                                  |
| <b>Configuration software</b>     |                        | SOPAS ET                                                                    |
| <b>Data storage and retrieval</b> |                        | Log for 30 images, record images on PC, store images to FTP                 |
| <b>Ethernet communication</b>     |                        | Web API                                                                     |
| <b>Digital input</b>              |                        | 4 inputs (24 V)                                                             |
| <b>Configurable inputs</b>        |                        | External trigger, encoder input, External teach, reference object selection |
| <b>Digital output</b>             |                        | 3 digital outputs, 24 V (B-type)                                            |
| <b>Configurable outputs</b>       |                        | Output by logical expressions, Additional image storage possibility via FTP |
| <b>Output current</b>             |                        | $\leq 100\text{ mA}$                                                        |
| <b>Standard outputs</b>           |                        | No object detected, Everything OK, Detail error                             |
| <b>Maximum encoder frequency</b>  |                        | Max. 40 kHz                                                                 |
| <b>External illumination</b>      |                        | 5 V TTL                                                                     |
| <b>I/O box extension</b>          |                        | 5 x inputs for object selection, 16 outputs                                 |

### Ambient data

|                                      |                                 |
|--------------------------------------|---------------------------------|
| <b>Shock load</b>                    | EN 60068-2-27                   |
| <b>Vibration load</b>                | IEC 60068-2-6                   |
| <b>Ambient operating temperature</b> | 0 °C ... +45 °C <sup>1)</sup>   |
| <b>Storage temperature</b>           | -20 °C ... +70 °C <sup>1)</sup> |

<sup>1)</sup> Relative humidity: 35% ... 85%, 95% in storage.

### Certificates

|                                                                              |   |
|------------------------------------------------------------------------------|---|
| <b>EU declaration of conformity</b>                                          | ✓ |
| <b>ACMA declaration of conformity</b>                                        | ✓ |
| <b>China RoHS</b>                                                            | ✓ |
| <b>cULus certificate</b>                                                     | ✓ |
| <b>Information according to Art. 3 of Data Act (Regulation EU 2023/2854)</b> | ✓ |

### Classifications

|                       |          |
|-----------------------|----------|
| <b>ECLASS 5.0</b>     | 27310205 |
| <b>ECLASS 5.1.4</b>   | 27310205 |
| <b>ECLASS 6.0</b>     | 27310205 |
| <b>ECLASS 6.2</b>     | 27310205 |
| <b>ECLASS 7.0</b>     | 27310205 |
| <b>ECLASS 8.0</b>     | 27310205 |
| <b>ECLASS 8.1</b>     | 27310205 |
| <b>ECLASS 9.0</b>     | 27310205 |
| <b>ECLASS 10.0</b>    | 27310205 |
| <b>ECLASS 11.0</b>    | 27310205 |
| <b>ECLASS 12.0</b>    | 27310205 |
| <b>ETIM 5.0</b>       | EC001820 |
| <b>ETIM 6.0</b>       | EC001820 |
| <b>ETIM 7.0</b>       | EC001820 |
| <b>ETIM 8.0</b>       | EC001820 |
| <b>UNSPSC 16.0901</b> | 43211731 |

Dimensional drawing Standard

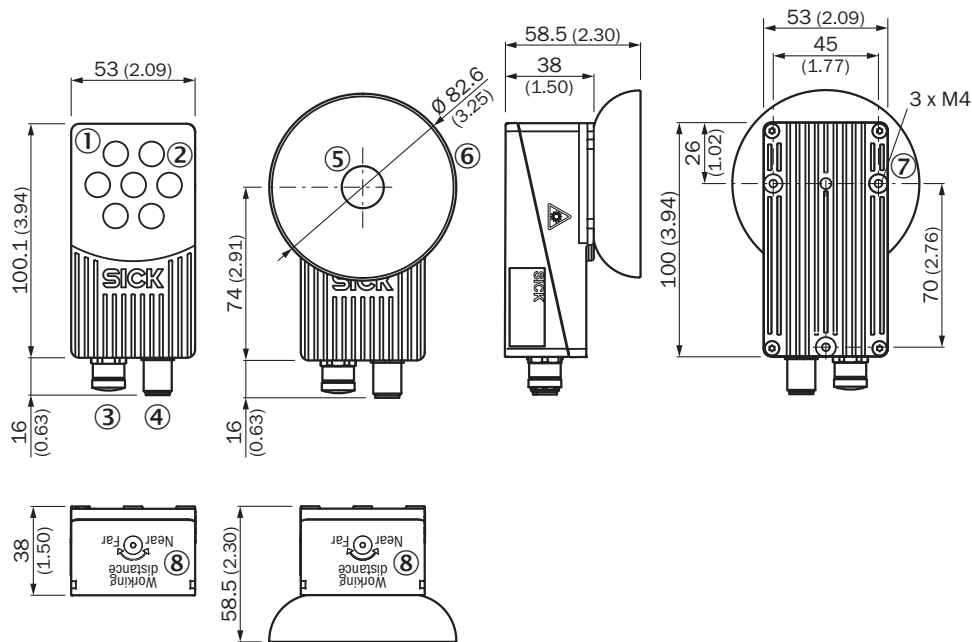

Dimensions in mm (inch)

- ① Front screen: standard, flex
- ② ring lighting
- ③ Ethernet connection M12, 4-pin, female
- ④ Power connection M12, 12-pin, male
- ⑤ Front screen: dome
- ⑥ dome light
- ⑦ Mounting hole M4
- ⑧ focus

### Field of view

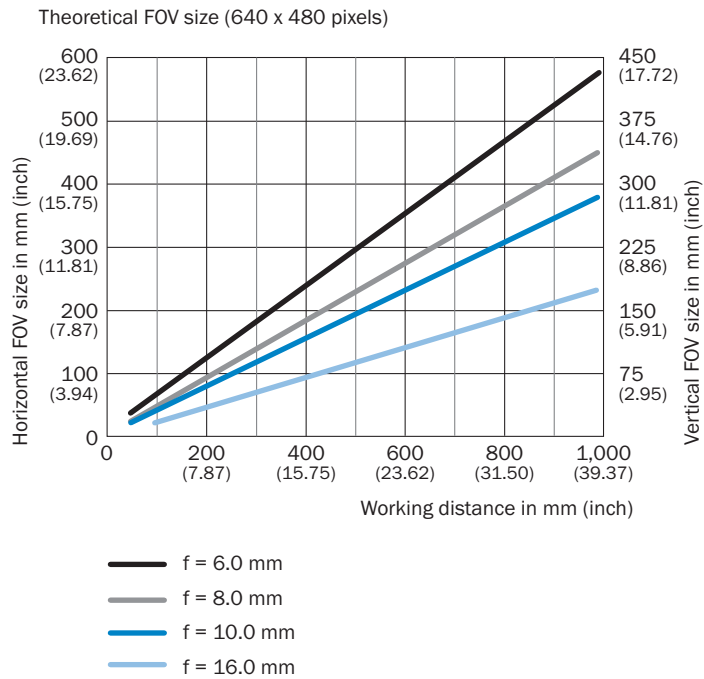

### Connection type

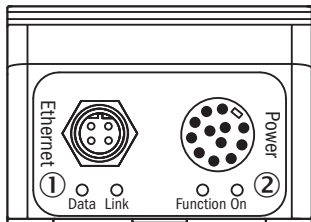

- ① Ethernet connection M12, 4-pin, female
- ② Power connection M12, 12-pin, male

### Ethernet connection diagram

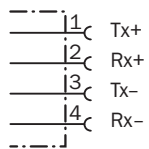



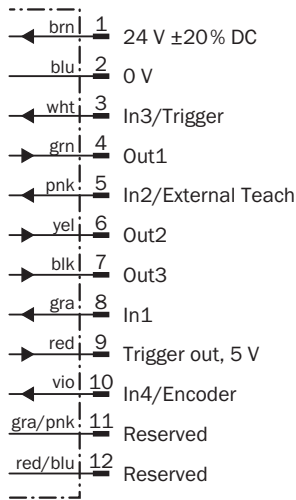



### M12 connection diagram, 12-pin



### Recommended accessories

Other models and accessories → [www.sick.com/Inspector](http://www.sick.com/Inspector)

|                                                                                     | Brief description                                                                                                                                                                                                                                                                                                                                                                                                                                                            | Type                                | part no. |
|-------------------------------------------------------------------------------------|------------------------------------------------------------------------------------------------------------------------------------------------------------------------------------------------------------------------------------------------------------------------------------------------------------------------------------------------------------------------------------------------------------------------------------------------------------------------------|-------------------------------------|----------|
| reflectors and optics                                                               |                                                                                                                                                                                                                                                                                                                                                                                                                                                                              |                                     |          |
|  | <ul style="list-style-type: none"> <li><b>Description:</b> Visible block filter for variants with exchangeable lens and front window, PMMA</li> </ul>                                                                                                                                                                                                                                                                                                                        | Inspector Flex visible block filter | 2073707  |
|  | <ul style="list-style-type: none"> <li><b>Description:</b> Visible block filter for variants with exchangeable lens and front window, glass</li> </ul>                                                                                                                                                                                                                                                                                                                       | Inspector Flex visible block filter | 2071856  |
|  | <ul style="list-style-type: none"> <li><b>Description:</b> Exchangeable lens, focal length 16 mm, including spacer ring</li> </ul>                                                                                                                                                                                                                                                                                                                                           | OBJ-B16018BA                        | 2049418  |
|  | <ul style="list-style-type: none"> <li><b>Description:</b> Exchangeable lens, focal length 6 mm</li> </ul>                                                                                                                                                                                                                                                                                                                                                                   | OBJ-B06025BA                        | 2049668  |
| connectors and cables                                                               |                                                                                                                                                                                                                                                                                                                                                                                                                                                                              |                                     |          |
|  | <ul style="list-style-type: none"> <li><b>Connection type head A:</b> Male connector, M12, 4-pin, straight, D-coded</li> <li><b>Connection type head B:</b> Male connector, RJ45, 4-pin, straight</li> <li><b>Signal type:</b> Ethernet, PROFINET</li> <li><b>Cable:</b> 2 m, 4-wire, PUR, halogen-free</li> <li><b>Description:</b> Ethernet, shielded, PROFINET</li> <li><b>Application:</b> Drag chain operation, Zones with oils and lubricants</li> </ul>               | YM2D24-020P-N1MRJA4                 | 2106182  |
|  | <ul style="list-style-type: none"> <li><b>Description:</b> Sensor/actuator cable, shielded</li> <li><b>Connection type head A:</b> Female connector, M12, 12-pin, straight, A-coded</li> <li><b>Connection type head B:</b> Flying leads</li> <li><b>Signal type:</b> Sensor/actuator cable</li> <li><b>Cable:</b> 5 m, 12-wire, PUR, halogen-free</li> <li><b>Application:</b> Drag chain operation, Zones with oils and lubricants, Robot, Drag chain operation</li> </ul> | YF2A2B-050UD2XLEAX                  | 2130999  |

## SICK AT A GLANCE

SICK is one of the leading manufacturers of intelligent sensors and sensor solutions for industrial applications. A unique range of products and services creates the perfect basis for controlling processes securely and efficiently, protecting individuals from accidents and preventing damage to the environment.

We have extensive experience in a wide range of industries and understand their processes and requirements. With intelligent sensors, we can deliver exactly what our customers need. In application centers in Europe, Asia and North America, system solutions are tested and optimized in accordance with customer specifications. All this makes us a reliable supplier and development partner.

Comprehensive services complete our offering: SICK LifeTime Services provide support throughout the machine life cycle and ensure safety and productivity.

For us, that is “Sensor Intelligence.”

## WORLDWIDE PRESENCE:

Contacts and other locations –[www.sick.com](http://www.sick.com)