



KTM-WN11182P

KTM

CONTRAST SENSORS

SICK
Sensor Intelligence.



Illustration may differ



Ordering information

Type	part no.
KTM-WN1182P	1062150

Other models and accessories → www.sick.com/KTM

Detailed technical data

Features

Housing design	Small
Dimensions (W x H x D)	12 mm x 31.5 mm x 21 mm
Light source	LED, RGB ¹⁾
Light emission	Long side of housing
Light spot size	1.6 mm x 9.5 mm
Light spot direction	Vertical ²⁾
Receiving filters	None
Wave length	470 nm, 525 nm, 625 nm
Sensing distance	≤ 12.5 mm
Sensing distance tolerance	± 3 mm
Display	LED indicator green: power on LED indicator, yellow: Status switching output Q
Adjustment	Teach-in button
Teach-in mode	2-point teach-in static/dynamic + proximity to mark ET: Teach-in dynamic

¹⁾ Average service life: 100,000 h at T_J = +25 °C.

²⁾ In relation to long side of housing.

Electronics

Supply voltage	12 V DC ... 24 V DC ¹⁾
-----------------------	-----------------------------------

¹⁾ Limit values: DC 12 V (-10 %) ... DC 24 V (+20 %). Operation in short-circuit protected network max. 8 A.

²⁾ May not fall below or exceed U_y tolerances.

³⁾ Without load.

⁴⁾ With light/dark ratio 1:1.

⁵⁾ Total current of all Outputs.

Ripple	$\leq 5 V_{pp}$ ²⁾
Current consumption	$< 50 \text{ mA}$ ³⁾
Switching frequency	15 kHz ⁴⁾
Response time	$32 \mu\text{s}$
Jitter	$15 \mu\text{s}$
Switching output	NPN
Switching output (voltage)	NPN: HIGH = approx. U_V / LOW $\leq 2 \text{ V}$
Switching mode	Light/dark switching
Output current I_{max}	50 mA ⁵⁾
Input, dynamic teach-in (ET)	NPN: Teach: $U < 2 \text{ V}$ NPN: Run: $U_V - 2 \text{ V}$ or open
Retention time (ET)	28 ms, non-volatile memory
Time delay	None
Protection class	III
Circuit protection	U_V connections, reverse polarity protected Output Q short-circuit protected Interference pulse suppression
Connection type	Cable with M12 male connector, 4-pin, 0.2 m

¹⁾ Limit values: DC 12 V (-10 %) ... DC 24 V (+20 %). Operation in short-circuit protected network max. 8 A.

²⁾ May not fall below or exceed U_V tolerances.

³⁾ Without load.

⁴⁾ With light/dark ratio 1:1.

⁵⁾ Total current of all Outputs.

Mechanics

Housing material	ABS
Optics material	PMMA
Weight	20 g

Ambient data

Ambient operating temperature	$-10 \text{ }^\circ\text{C} \dots +55 \text{ }^\circ\text{C}$
Ambient temperature, storage	$-20 \text{ }^\circ\text{C} \dots +75 \text{ }^\circ\text{C}$
Shock load	According to IEC 60068
Enclosure rating	IP67
UL File No.	NRKH.E348498 & NRKH7.E348498

Connection type/pinouts

Connection type	Cable with M12 male connector, 4-pin, 0.2 m
Pinouts	
BN 1	+ (L+)
WH 2	ET
BU 3	- (M)
BK 4	Q

Certificates

EU declaration of conformity	✓
UK declaration of conformity	✓
ACMA declaration of conformity	✓
Moroccan declaration of conformity	✓
China RoHS	✓
cULus certificate	✓
Photobiological safety (IEC EN 62471)	✓

Classifications

ECLASS 5.0	27270906
ECLASS 5.1.4	27270906
ECLASS 6.0	27270906
ECLASS 6.2	27270906
ECLASS 7.0	27270906
ECLASS 8.0	27270906
ECLASS 8.1	27270906
ECLASS 9.0	27270906
ECLASS 10.0	27270906
ECLASS 11.0	27270906
ECLASS 12.0	27270906
ETIM 5.0	EC001820
ETIM 6.0	EC001820
ETIM 7.0	EC001820
ETIM 8.0	EC001820
UNSPSC 16.0901	39121528

Dimensional drawing KTM-Mxxxxx2P, KTM-Wxxxxx2P

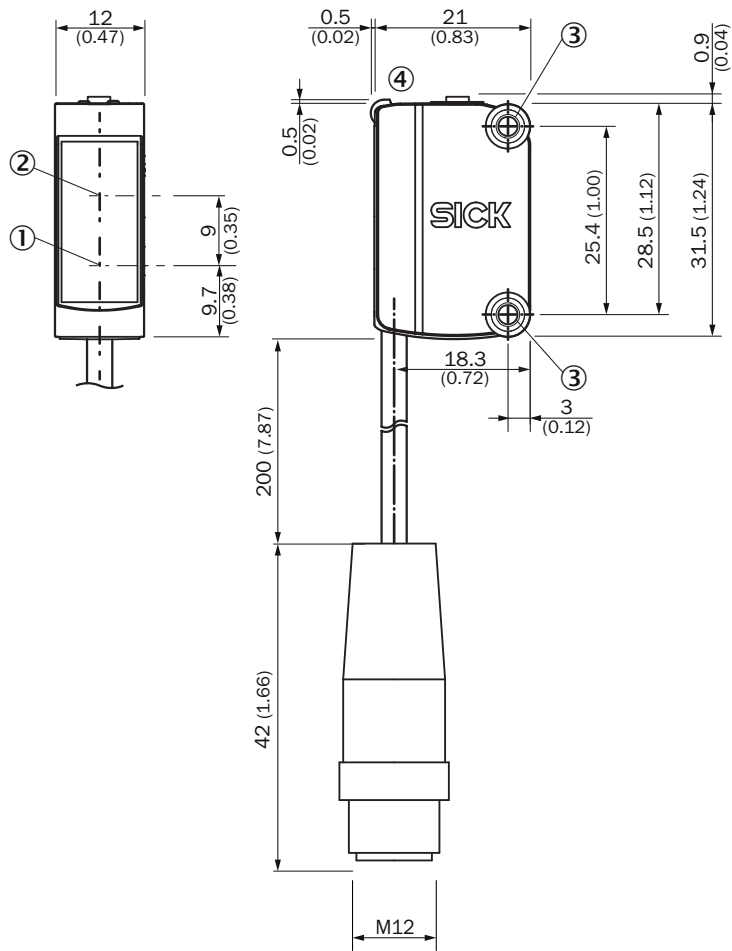

Dimensions in mm (inch)

- ① Center of optical axis, sender
- ② Center of optical axis, receiver
- ③ Mounting holes M3
- ④ display and adjustment elements

Pinouts, see table [Technical data: Connection type/pinouts](#)

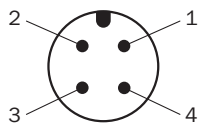

M12 male connector, 4-pin, A-coding

display and adjustment elements

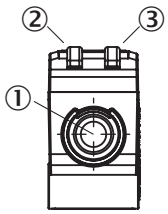

- ① Teach-in button
- ② LED yellow
- ③ LED green

Setting the switching threshold (static)

1. Position mark

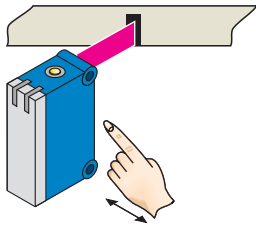

Press and hold teach-in button $> 1 < 3$ s.
Yellow LED flashes slowly.

2. Position background

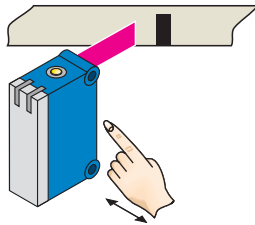

Press and hold teach-in button < 3 s.
Yellow LED goes out.

Setting the switching threshold (dynamic)

1. Position background

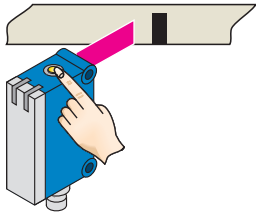

Press the teach-in button and keep it pressed. LED flashing slowly.

2. Move at least the mark and background using the light spot.



Keep the teach-in button > 3 < 30 s pressed.



Release the teach-in button.



Yellow LED will illuminate, when emitted light is on the mark.

Example

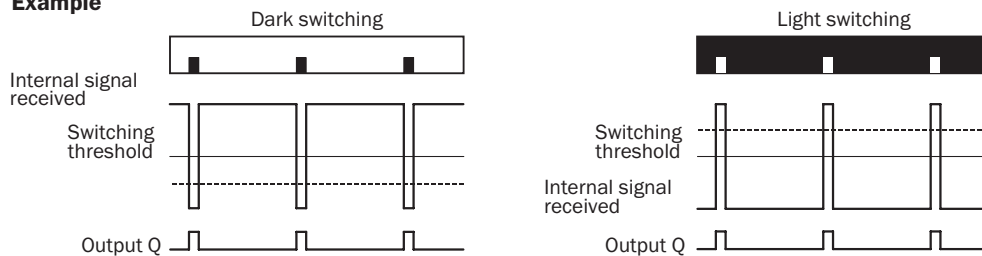

Switching characteristics

The optimum emitted light is selected automatically (at RGB variants).

Static teach-in: light/dark setting is defined using teach-in sequence.

Dynamic teach-in: switching output active on mark, if background is longer in the field of view during the teach-in.

The switching threshold is set in the center between the background and the mark.

If the button is pressed again within 10 s of the teach (> 20 ms < 10 s), the relative switching threshold is placed 75 % between mark (100 %) and background (0 %) (dotted line in Figure).

Teach-in can also be performed using an external control signal.

Keylock activation and deactivation: hold down teach-in button > 30 s.

Teach-in failure: yellow LED indicator and the transmitted light of the sensor flashing quickly.

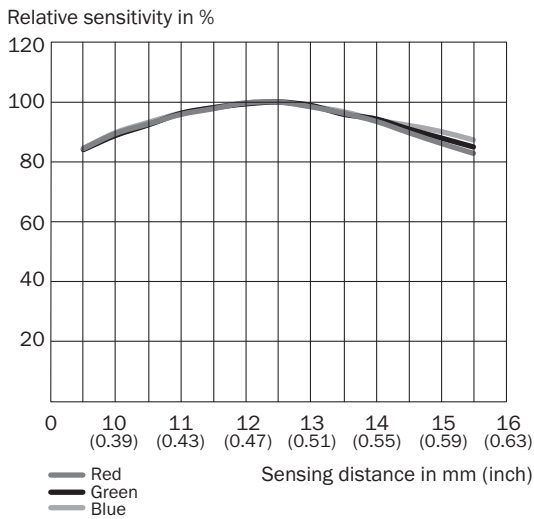

For dynamic teach-in with ET signal (5 Hz) via switching output Q.

Sensing distance



Recommended accessories

Other models and accessories → www.sick.com/KTM

	Brief description	Type	part no.
Mounting systems			
	<ul style="list-style-type: none"> Description: Mounting bracket for wall mounting Material: Stainless steel Details: Stainless steel Items supplied: Mounting hardware included Suitable for: W8, W8G, W8 Laser, W8 Inox, G6, G6 Inox, W100 Laser, W100-2, KTM Core, KTM Prime, CSM, LUTM, W4S 	BEF-W100-A	5311520
connectors and cables			
	<ul style="list-style-type: none"> Description: Sensor/actuator cable, unshielded Connection type head A: Female connector, M12, 4-pin, straight, A-coded Connection type head B: Male connector, M12, 4-pin, straight, A-coded Signal type: Sensor/actuator cable Cable: 5 m, 4-wire, PVC Application: Uncontaminated zones, Zones with chemicals 	YF2A14-050VB3M2A14	2096600
	<ul style="list-style-type: none"> Description: Sensor/actuator cable, unshielded Connection type head A: Female connector, M12, 4-pin, straight, A-coded Connection type head B: Flying leads Signal type: Sensor/actuator cable Cable: 5 m, 4-wire, PVC Application: Uncontaminated zones, Zones with chemicals 	YF2A14-050VB3XLEAX	2096235

SICK AT A GLANCE

SICK is one of the leading manufacturers of intelligent sensors and sensor solutions for industrial applications. A unique range of products and services creates the perfect basis for controlling processes securely and efficiently, protecting individuals from accidents and preventing damage to the environment.

We have extensive experience in a wide range of industries and understand their processes and requirements. With intelligent sensors, we can deliver exactly what our customers need. In application centers in Europe, Asia and North America, system solutions are tested and optimized in accordance with customer specifications. All this makes us a reliable supplier and development partner.

Comprehensive services complete our offering: SICK LifeTime Services provide support throughout the machine life cycle and ensure safety and productivity.

For us, that is “Sensor Intelligence.”

WORLDWIDE PRESENCE:

Contacts and other locations –www.sick.com