



# V3T11S-MR12A8

TriSpector1000

3D MACHINE VISION

**SICK**  
Sensor Intelligence.



### Ordering information

Type	part no.
V3T11S-MR12A8	1060426

Other models and accessories → [www.sick.com/TriSpector1000](http://www.sick.com/TriSpector1000)



### Detailed technical data

#### Features

<b>Technology</b>	3D laser triangulation
<b>Configurable</b>	✓
<b>Pre-calibrated</b>	✓
<b>Toolkit</b>	Shape Area detection Blob Finder Volume Find plane Fixed plane
<b>Working range</b>	56 mm ... 116 mm
<b>Example field of view</b>	65 mm x 15 mm
<b>Illumination</b>	Integrated
<b>Illumination color</b>	Red, laser, Visible, 660 nm, ± 7 nm
<b>Laser class</b>	2 (EN 60825-1:2014+A11:2021; IEC 60825-1:2014, Complies with the FDA performance requirements for laser products except for conformance with IEC 60825-1 Ed.3., as described in Laser Notice 56 dated May 8, 2019.)
<b>Width at minimum operating distance</b>	40 mm
<b>Width at maximum operating distance</b>	75 mm
<b>Maximum height range</b>	60 mm
<b>Imaging angle</b>	65°
<b>Offline support</b>	Emulator
<b>Task</b>	Detecting - Standard objects Detecting - Level Measuring - Dimension, contour and volume Measuring - Number Monitoring and controlling - Quality Determining position - 3D position determination

#### Mechanics/electronics

<b>Connector material</b>	Nickel plated brass
<b>Supply voltage</b>	24 V DC, ± 20 %
<b>Ripple</b>	< 5 V <sub>pp</sub>
<b>Power consumption</b>	≤ 11 W
<b>Current consumption</b>	≤ < 450 mA Without output load

<b>Enclosure rating</b>	IP67
<b>Protection class</b>	III
<b>Housing material</b>	Anodized aluminum
<b>Window material</b>	PMMA
<b>Weight</b>	0.9 kg
<b>Dimensions (L x W x H)</b>	136 mm x 62 mm x 84 mm

## Performance

<b>Scan/frame rate</b>	5,000 3D profiles/s
<b>Maximum number of profiles</b>	2,500 Per image
<b>Data points/profile</b>	1,536
<b>Height resolution</b>	20 µm ... 50 µm
<b>3D profile resolution</b>	0.049 mm/px

## Interfaces

<b>Ethernet</b>	✓, TCP/IP
Data transmission rate	1,000 Mbit/s
<b>Serial</b>	✓, RS-232, RS-422
Function	Encoder (RS-422 / DBS36E-BBCP02048)
Data transmission rate	Maximum encoder frequency: 300 MHz
<b>Incremental</b>	✓, TTL
<b>Configuration software</b>	SOPAS ET
<b>Digital input</b>	3 (non-isolated)
<b>Digital output</b>	4 (non-isolated)
<b>Encoder interface</b>	RS-422 / TTL (DBS36E-BBCP02048)
<b>Maximum encoder frequency</b>	Max. 300 kHz

## Ambient data

<b>Electromagnetic compatibility (EMC)</b>	EN 61000-6-2:2005 / EN 61000-6-3:2007
<b>Shock load</b>	15 g / 6 ms (EN 60068-2-27)
<b>Vibration load</b>	5 g, 10 Hz ... 150 Hz (EN 60068-2-6)
<b>Ambient operating temperature</b>	0 °C ... +45 °C
<b>Storage temperature</b>	-20 °C ... +70 °C <sup>1)</sup>

<sup>1)</sup> Permissible relative humidity: 0% ... 90% (non-condensing).

## Certificates

<b>EU declaration of conformity</b>	✓
<b>UK declaration of conformity</b>	✓
<b>ACMA declaration of conformity</b>	✓
<b>China RoHS</b>	✓
<b>cTUVus certificate</b>	✓
<b>Information according to Art. 3 of Data Act (Regulation EU 2023/2854)</b>	✓

### Classifications

<b>ECLASS 5.0</b>	27310205
<b>ECLASS 5.1.4</b>	27310205
<b>ECLASS 6.0</b>	27310205
<b>ECLASS 6.2</b>	27310205
<b>ECLASS 7.0</b>	27310205
<b>ECLASS 8.0</b>	27310205
<b>ECLASS 8.1</b>	27310205
<b>ECLASS 9.0</b>	27310205
<b>ECLASS 10.0</b>	27310205
<b>ECLASS 11.0</b>	27310205
<b>ECLASS 12.0</b>	27310205
<b>ETIM 5.0</b>	EC001820
<b>ETIM 6.0</b>	EC001820
<b>ETIM 7.0</b>	EC001820
<b>ETIM 8.0</b>	EC001820
<b>UNSPSC 16.0901</b>	43211731

### Dimensional drawing

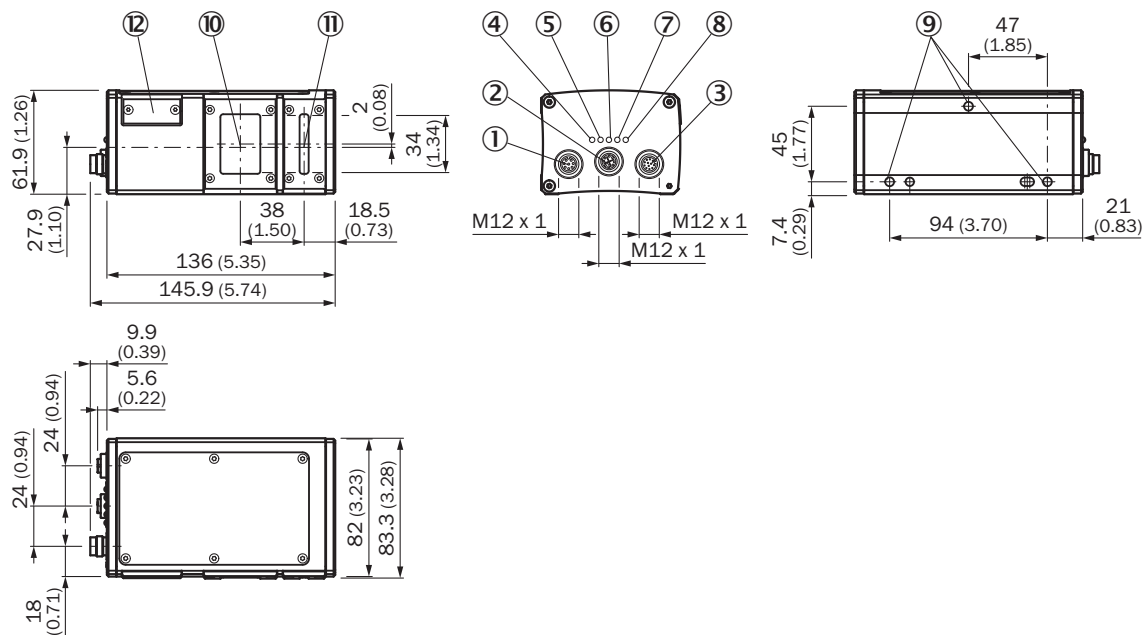

Dimensions in mm (inch)

- ① Connector Encoder (thread inside)
- ② Gigabit Ethernet connection (GbE)
- ③ Connector Power I/O (thread inside)
- ④ LED; On
- ⑤ LED; State
- ⑥ LED; Link/Data
- ⑦ LED; Result

- ⑧ LED; Laser
- ⑨ Fastening threads (M5 x 8.5 mm length)
- ⑩ Optical receiver (center)
- ⑪ Optical sender (center)
- ⑫ Micro SD memory card

### Field of view

#### TriSpector1008

Typ. field of view in mm (inch)

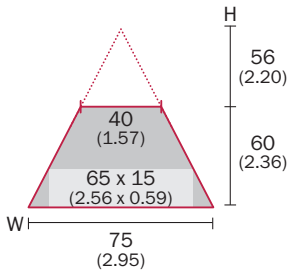

### Field of view



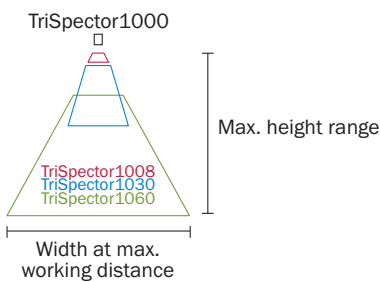



#### Typical field of view



### Recommended accessories

Other models and accessories → [www.sick.com/TriSpector1000](http://www.sick.com/TriSpector1000)

	Brief description	Type	part no.
<b>Mounting systems</b>			
	<ul style="list-style-type: none"> <li><b>Description:</b> Mounting bracket set consisting of mounting bracket, cooling plate, includes angle display for setting the tilt angle</li> <li><b>Suitable for:</b> Lector63x, Inspector63x, Lector83x – up to 40 °C ambient operating temperature, Inspector83x – up to 40 °C ambient operating temperature, Lector83x – up to 40 °C ambient operating temperature, Insepctor83x – up to 40 °C ambient operating temperature, Lector63x, Inspector63x</li> </ul>	Mounting bracket set with inclination angle -40° - 40°	2076735

	Brief description	Type	part no.
connectors and cables			
	<ul style="list-style-type: none"> <li><b>Description:</b> Sensor/actuator cable, shielded</li> <li><b>Connection type head A:</b> Female connector, M12, 8-pin, straight, A-coded</li> <li><b>Connection type head B:</b> Male connector, M12, 8-pin, straight, A-coded</li> <li><b>Signal type:</b> Sensor/actuator cable</li> <li><b>Cable:</b> 2 m, 8-wire, PUR, halogen-free</li> <li><b>Application:</b> Drag chain operation, Zones with oils and lubricants, Robot, Drag chain operation</li> </ul>	YF2A28-020UA6M2A28	2096105
	<ul style="list-style-type: none"> <li><b>Description:</b> Power, shielded, Digital I/Os, Serial</li> <li><b>Connection type head A:</b> Female connector, M12, 12-pin, straight</li> <li><b>Connection type head B:</b> Male connector, M12, 17-pin, straight</li> <li><b>Signal type:</b> Power, digital I/Os, serial</li> <li><b>Cable:</b> 0.25 m</li> </ul>	YF2AAB-C25S01M2AAD	2086398
	<ul style="list-style-type: none"> <li><b>Description:</b> Shielded</li> <li><b>Connection type head A:</b> Male connector, M12, 5-pin, straight</li> <li><b>Connection type head B:</b> Flying leads</li> <li><b>Cable:</b> 2 m</li> <li><b>Connection systems:</b> Flying leads</li> </ul>	Connecting cable	6024860
	<ul style="list-style-type: none"> <li><b>Description:</b> Power</li> <li><b>Connection type head A:</b> Female connector, M12, 12-pin, straight</li> <li><b>Connection type head B:</b> Male connector, M12, 5-pin, straight</li> <li><b>Signal type:</b> Power</li> <li><b>Cable:</b> 0.25 m</li> </ul>	YF2A6B-C25XXM2A15	2079766
	<ul style="list-style-type: none"> <li><b>Description:</b> Sensor/actuator cable, shielded</li> <li><b>Connection type head A:</b> Male connector, M12, 8-pin, straight, A-coded</li> <li><b>Connection type head B:</b> Flying leads</li> <li><b>Signal type:</b> Sensor/actuator cable</li> <li><b>Cable:</b> 5 m, 8-wire, PVC</li> <li><b>Application:</b> Uncontaminated zones, Zones with chemicals</li> </ul>	YM2A28-050VA6XLEAX	2096233
	<ul style="list-style-type: none"> <li><b>Connection type head A:</b> Male connector, M12, 8-pin, straight, X-coded</li> <li><b>Connection type head B:</b> Male connector, RJ45, 8-pin, straight</li> <li><b>Signal type:</b> Ethernet, Gigabit Ethernet</li> <li><b>Cable:</b> 2 m, 8-wire, PUR, halogen-free</li> <li><b>Description:</b> Ethernet, shielded, Gigabit Ethernet</li> <li><b>Application:</b> Zones with oils and lubricants</li> </ul>	YM2X18-020EG1M-RJA8	2106258
	<ul style="list-style-type: none"> <li><b>Connection type head A:</b> Male connector, M12, 8-pin, straight, X-coded</li> <li><b>Connection type head B:</b> Male connector, RJ45, 8-pin, straight</li> <li><b>Signal type:</b> Ethernet, Gigabit Ethernet</li> <li><b>Cable:</b> 3 m, 8-wire, PUR, halogen-free</li> <li><b>Description:</b> Ethernet, shielded, Gigabit Ethernet</li> <li><b>Application:</b> Zones with oils and lubricants</li> </ul>	YM2X18-030EG1M-RJA8	2145693

## SICK AT A GLANCE

SICK is one of the leading manufacturers of intelligent sensors and sensor solutions for industrial applications. A unique range of products and services creates the perfect basis for controlling processes securely and efficiently, protecting individuals from accidents and preventing damage to the environment.

We have extensive experience in a wide range of industries and understand their processes and requirements. With intelligent sensors, we can deliver exactly what our customers need. In application centers in Europe, Asia and North America, system solutions are tested and optimized in accordance with customer specifications. All this makes us a reliable supplier and development partner.

Comprehensive services complete our offering: SICK LifeTime Services provide support throughout the machine life cycle and ensure safety and productivity.

For us, that is “Sensor Intelligence.”

## WORLDWIDE PRESENCE:

Contacts and other locations –[www.sick.com](http://www.sick.com)