



DFV60E-22EK01024

DFV60

MEASURING WHEEL ENCODERS

SICK
Sensor Intelligence.



Ordering information

Type	part no.
DFV60E-22EK01024	1060309

Other models and accessories → www.sick.com/DFV60

Illustration may differ



Detailed technical data

Features

Items supplied	DFV60 spring arm (part number: 2056155) not included with delivery
-----------------------	--

Safety-related parameters

MTTF_D (mean time to dangerous failure)	300 years (EN ISO 13849-1) ¹⁾
--	--

¹⁾ This product is a standard product and does not constitute a safety component as defined in the Machinery Directive. Calculation based on nominal load of components, average ambient temperature 40°C, frequency of use 8760 h/a. All electronic failures are considered hazardous. For more information, see document no. 8015532.

Performance

Pulses per revolution	1,024
Resolution in pulses/mm	3.41 Pulses/mm ¹⁾
Measuring increment (resolution in mm/pulse)	0.03 mm/pulse ²⁾
Measuring step deviation	± 0.008° ³⁾
Error limits	± 4 mm/m, subject to measuring wheel (measuring wheel surface + measuring surface + ambient conditions)
Initialization time	30 ms

¹⁾ Calculation example: Pulses per revolution / measuring wheel circumference = 16,384 pulses per revolution / 200 mm = 81.92 pulses/mm.

²⁾ Calculation example: Circumference of wheel / pulses per revolution = 200 mm / 16384 pulses per revolution = 0,012mm/pulse.

³⁾ Value refers to the mounted encoder.

Interfaces

Communication interface	Incremental
Communication Interface detail	HTL / Push pull

Electronics

Connection type	Cable, 8-wire, universal, 1.5 m
------------------------	---------------------------------

Power consumption max. without load	≤ 30 mA
Supply voltage	10 V ... 32 V
Load current max.	30 mA
Maximum output frequency	820 kHz
Reference signal, number	1
Reference signal, position	90°, electric, logically gated with A and B
Reverse polarity protection	✓
Short-circuit protection of the outputs	✓

Mechanics

Measuring wheel circumference	300 mm
Measuring wheel surface	O-ring NBR70 ¹⁾
Mass	+ 500 g
Encoder material	
Shaft	Stainless steel
Flange	Aluminum
Housing	Aluminum
Cable	PUR
Spring arm mechanism material	
Spring element	Not contained in the scope of delivery of the system
Measuring wheel core	Aluminum
Start up torque	0.8 Ncm (at 20 °C)
Operating torque	0.6 Ncm (at 20 °C)
Operating speed	1,500 min ⁻¹
Maximum operating speed	3,000 min ⁻¹ ²⁾
Bearing lifetime	3 x 10 ⁹ revolutions
Maximum travel/deflection of spring arm	40 mm
Max. permissible working area for the spring (continuous operation)	± 10 mm
Recommended spring deflection	20 mm ... 40 mm
Mounting position relative to the measuring object	Preferably from above, from below possible

¹⁾ The surface of a measuring wheel is subject to wear. This depends on contact pressure, acceleration behavior in the application, traversing speed, measurement surface, mechanical alignment of the measuring wheel, temperature, and ambient conditions. We recommend you regularly check the condition of the measuring wheel and replace as required.

²⁾ Allow for self-heating of 3.3 K per 1,000 rpm when designing the operating temperature range.

Ambient data

EMC	According to EN 61000-6-2 and EN 61000-6-4
Enclosure rating	IP65
Permissible relative humidity	90 % (Condensation not permitted)
Operating temperature range	-20 °C ... +100 °C
Storage temperature range	-40 °C ... +100 °C, without package
Resistance to shocks	70 g, 6 ms (EN 60068-2-27)
Resistance to vibration	30 g, 10 Hz ... 2,000 Hz (EN 60068-2-6)

Certificates

EU declaration of conformity	✓
UK declaration of conformity	✓
ACMA declaration of conformity	✓
Moroccan declaration of conformity	✓
China RoHS	✓
Information according to Art. 3 of Data Act (Regulation EU 2023/2854)	✓

Classifications

ECLASS 5.0	27270501
ECLASS 5.1.4	27270501
ECLASS 6.0	27270590
ECLASS 6.2	27270590
ECLASS 7.0	27270501
ECLASS 8.0	27270501
ECLASS 8.1	27270501
ECLASS 9.0	27270501
ECLASS 10.0	27270790
ECLASS 11.0	27270707
ECLASS 12.0	27270504
ETIM 5.0	EC001486
ETIM 6.0	EC001486
ETIM 7.0	EC001486
ETIM 8.0	EC001486
UNSPSC 16.0901	41112113

Dimensional drawing DFV60 spring arm (part number: 2056155) not included with delivery

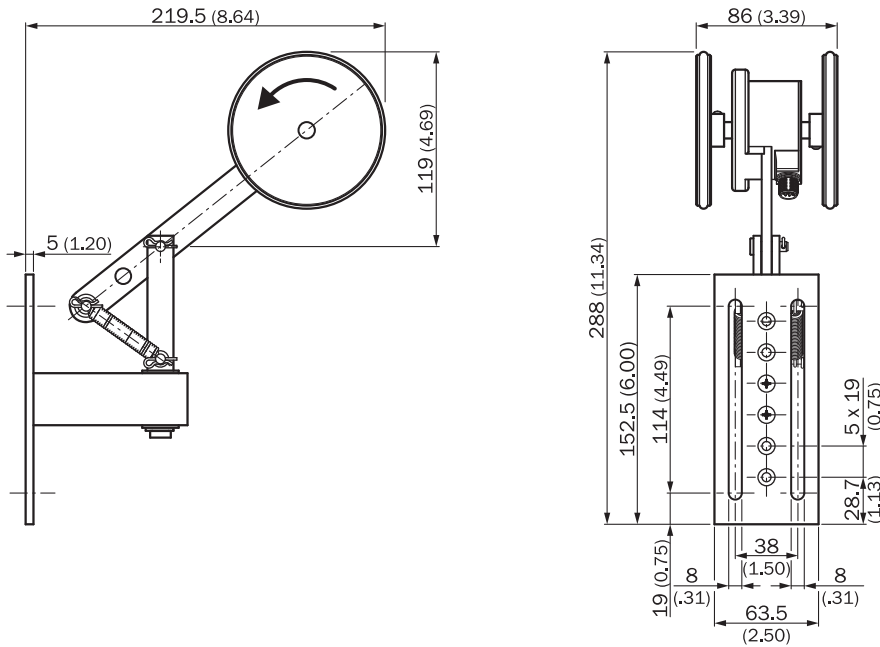

Dimensions in mm (inch)

Anschlussbelegung

Cable 8-core

View to the connector M12 fitted to the encoder body

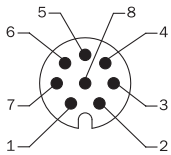

PIN, 8-pin, connector M12	Color of wires for encoders with cable outlet	Signal TTL, HTL	Explanation
1	Brown	\bar{A}	Signal line
2	White	A	Signal line
3	Black	\bar{B}	Signal line
4	Pink	B	Signal line
5	Yellow	\bar{Z}	Signal line
6	Lilac	Z	Signal line
7	Blue	GND	Ground connection of the encoder
8	Red	+U _s	Supply voltage (potential free to housing)
Screen	Screen	Screen	Screen connected to encoder housing. On the control side connected to earth.

Diagrams Dual wheel, spring tension, yoke mount

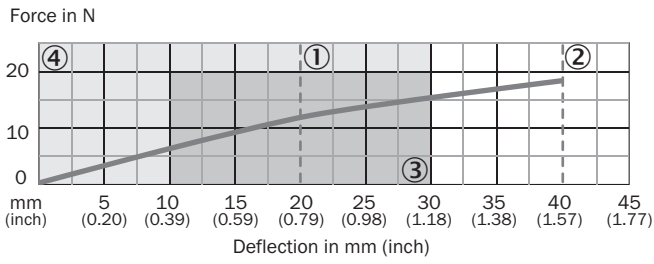

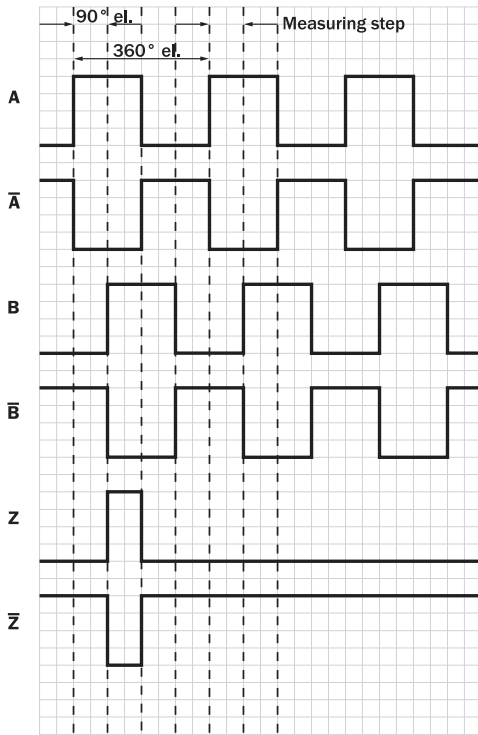

- ① recommended pre-tension (20 mm)
- ② maximum deflection (40 mm)
- ③ recommended deflection range (10 – 30 mm)
- ④ permissible working area (0 – 30 mm)

Diagrams















Recommended accessories





Other models and accessories → www.sick.com/DFV60

	Brief description	Type	part no.
measuring wheels and measuring wheel mechanics			
	<ul style="list-style-type: none"> • Product segment: Measuring wheels and measuring wheel mechanics • Product: Measuring wheels • Description: Aluminium measuring wheel with O-ring (NBR70) for 10 mm solid shaft, circumference 300 mm 	BEF-MR010030R	2049278
	<ul style="list-style-type: none"> • Product segment: Measuring wheels and measuring wheel mechanics • Product: Measuring wheel mechanics • Description: O-ring for measuring wheels (circumference 300 mm) • Items supplied: 2x O-ring 	BEF-OR-083-050	2064076
Mounting systems			
	<ul style="list-style-type: none"> • Description: Spring arm / mounting arm for DFV60 	DFV60 spring arm	2056155

	Brief description	Type	part no.
connectors and cables			
	<ul style="list-style-type: none"> Description: Incremental, shielded, SSI Connection type head A: Female connector, JST, 8-pin, straight Connection type head B: Flying leads Signal type: Incremental, SSI Items supplied: JST including sealing Cable: 0.5 m, 8-wire, PUR, halogen-free 	DOL-0J08-G0M5AA3	2046873
	<ul style="list-style-type: none"> Description: Incremental, shielded Connection type head A: Female connector, JST, 8-pin, straight Connection type head B: Flying leads Signal type: Incremental Items supplied: JST including sealing Cable: 1.5 m, 8-wire, PUR, halogen-free 	DOL-0J08-G1M5AA3	2046874
	<ul style="list-style-type: none"> Description: SSI, shielded, Incremental Connection type head A: Female connector, JST, 8-pin, straight Connection type head B: Flying leads Signal type: SSI, Incremental Items supplied: JST including sealing Cable: 1.5 m, 8-wire, PUR, halogen-free 	DOL-0J08-G1M5AA6	2048590
	<ul style="list-style-type: none"> Description: Incremental, shielded, SSI Connection type head A: Female connector, JST, 8-pin, straight Connection type head B: Flying leads Signal type: Incremental, SSI Items supplied: JST including sealing Cable: 10 m, 8-wire, PUR, halogen-free 	DOL-0J08-G10MAA3	2046877
	<ul style="list-style-type: none"> Description: SSI, shielded, Incremental Connection type head A: Female connector, JST, 8-pin, straight Connection type head B: Flying leads Signal type: SSI, Incremental Items supplied: JST including sealing Cable: 3 m, 8-wire, PUR, halogen-free 	DOL-0J08-G3M0AA6	2048591
	<ul style="list-style-type: none"> Description: Incremental, shielded, SSI Connection type head A: Female connector, M12, 8-pin, straight Connection type head B: Flying leads Signal type: Incremental, SSI Cable: 2 m, 8-wire, PUR, halogen-free Connection systems: Flying leads Application: Drag chain operation, Zones with oils and lubricants 	DOL-1208-G02MAC1	6032866
	<ul style="list-style-type: none"> Description: Incremental, shielded, SSI Connection type head A: Female connector, M12, 8-pin, straight Connection type head B: Flying leads Signal type: Incremental, SSI Cable: 5 m, 8-wire, PUR, halogen-free Connection systems: Flying leads Application: Drag chain operation, Zones with oils and lubricants 	DOL-1208-G05MAC1	6032867
	<ul style="list-style-type: none"> Description: Incremental, shielded, SSI Connection type head A: Female connector, M12, 8-pin, straight Connection type head B: Flying leads Signal type: Incremental, SSI Cable: 10 m, 8-wire, PUR, halogen-free Connection systems: Flying leads Application: Drag chain operation, Zones with oils and lubricants 	DOL-1208-G10MAC1	6032868
	<ul style="list-style-type: none"> Description: Incremental, shielded, SSI Connection type head A: Female connector, M12, 8-pin, straight Connection type head B: Flying leads Signal type: Incremental, SSI Cable: 20 m, 8-wire, PUR, halogen-free Connection systems: Flying leads Application: Drag chain operation, Zones with oils and lubricants 	DOL-1208-G20MAC1	6032869
	<ul style="list-style-type: none"> Description: Incremental, shielded, SSI Connection type head A: Female connector, M12, 8-pin, straight Connection type head B: Flying leads Signal type: Incremental, SSI Cable: 25 m, 8-wire, PUR, halogen-free Connection systems: Flying leads Application: Drag chain operation, Zones with oils and lubricants 	DOL-1208-G25MAC1	6067859
	<ul style="list-style-type: none"> Description: Incremental, shielded Connection type head A: Female connector, M23, 12-pin, straight Connection type head B: Flying leads 	DOL-2312-G02MLA3	2030682

	Brief description	Type	part no.
	<ul style="list-style-type: none"> • Signal type: Incremental • Cable: 2 m, 11-wire, PUR • Application: Zones with oils and lubricants 		
	<ul style="list-style-type: none"> • Description: Incremental, shielded • Connection type head A: Female connector, M23, 12-pin, straight • Connection type head B: Flying leads • Signal type: Incremental • Cable: 3 m, 12-wire, PUR, halogen-free • Application: Zones with oils and lubricants 	DOL-2312-G03MMA3	2029213
	<ul style="list-style-type: none"> • Description: Incremental, shielded • Connection type head A: Female connector, M23, 12-pin, straight • Connection type head B: Flying leads • Signal type: Incremental • Cable: 5 m, 12-wire, PUR, halogen-free • Application: Zones with oils and lubricants 	DOL-2312-G05MMA3	2029214
	<ul style="list-style-type: none"> • Description: Incremental, shielded • Connection type head A: Female connector, M23, 12-pin, straight • Connection type head B: Flying leads • Signal type: Incremental • Cable: 7 m, 11-wire, PUR • Application: Zones with oils and lubricants 	DOL-2312-G07MLA3	2030685
	<ul style="list-style-type: none"> • Description: Incremental, shielded • Connection type head A: Female connector, M23, 12-pin, straight • Connection type head B: Flying leads • Signal type: Incremental • Cable: 1.5 m, 12-wire, PUR, halogen-free • Application: Zones with oils and lubricants 	DOL-2312-G1M5MA3	2029212
	<ul style="list-style-type: none"> • Description: Incremental, shielded • Connection type head A: Female connector, M23, 12-pin, straight • Connection type head B: Flying leads • Signal type: Incremental • Cable: 10 m, 11-wire, PUR • Application: Zones with oils and lubricants 	DOL-2312-G10MLA3	2030688
	<ul style="list-style-type: none"> • Description: Incremental, shielded • Connection type head A: Female connector, M23, 12-pin, straight • Connection type head B: Flying leads • Signal type: Incremental • Cable: 10 m, 12-wire, PUR, halogen-free • Application: Zones with oils and lubricants 	DOL-2312-G10MMA3	2029215
	<ul style="list-style-type: none"> • Description: Incremental, shielded • Connection type head A: Female connector, M23, 12-pin, straight • Connection type head B: Flying leads • Signal type: Incremental • Cable: 15 m, 11-wire, PUR • Application: Zones with oils and lubricants 	DOL-2312-G15MLA3	2030692
	<ul style="list-style-type: none"> • Description: Incremental, shielded • Connection type head A: Female connector, M23, 12-pin, straight • Connection type head B: Flying leads • Signal type: Incremental • Cable: 20 m, 11-wire, PUR • Application: Zones with oils and lubricants 	DOL-2312-G20MLA3	2030695
	<ul style="list-style-type: none"> • Description: Incremental, shielded • Connection type head A: Female connector, M23, 12-pin, straight • Connection type head B: Flying leads • Signal type: Incremental • Cable: 20 m, 12-wire, PUR, halogen-free • Application: Zones with oils and lubricants 	DOL-2312-G20MMA3	2029216
	<ul style="list-style-type: none"> • Description: Incremental, shielded • Connection type head A: Female connector, M23, 12-pin, straight • Connection type head B: Flying leads • Signal type: Incremental • Cable: 25 m, 11-wire, PUR • Application: Zones with oils and lubricants 	DOL-2312-G25MLA3	2030699
	<ul style="list-style-type: none"> • Description: Incremental, shielded • Connection type head A: Female connector, M23, 12-pin, straight • Connection type head B: Flying leads • Signal type: Incremental • Cable: 30 m, 11-wire, PUR 	DOL-2312-G30MLA3	2030702

	Brief description	Type	part no.
	<ul style="list-style-type: none"> Application: Zones with oils and lubricants Description: Incremental, shielded Connection type head A: Female connector, M23, 12-pin, straight Connection type head B: Flying leads Signal type: Incremental Cable: 30 m, 12-wire, PUR, halogen-free Application: Zones with oils and lubricants 	DOL-2312-G30MMA3	2029217
	<ul style="list-style-type: none"> Description: SSI, shielded, Incremental, HIPERFACE® Connection type head A: Flying leads Connection type head B: Flying leads Signal type: SSI, Incremental, HIPERFACE® Items supplied: By the meter Cable: 8-wire, PUR, halogen-free 	LTG-2308-MWENC	6027529
	<ul style="list-style-type: none"> Description: SSI, shielded, Incremental Connection type head A: Flying leads Connection type head B: Flying leads Signal type: SSI, Incremental Items supplied: By the meter Cable: 11-wire, PUR 	LTG-2411-MW	6027530
	<ul style="list-style-type: none"> Description: SSI, shielded, Incremental Connection type head A: Flying leads Connection type head B: Flying leads Signal type: SSI, Incremental Items supplied: By the meter Cable: 12-wire, PUR, halogen-free 	LTG-2512-MW	6027531
	<ul style="list-style-type: none"> Description: SSI, shielded, TTL, HTL, Incremental Connection type head A: Flying leads Connection type head B: Flying leads Signal type: SSI, TTL, HTL, Incremental Items supplied: By the meter Cable: 12-wire, UV and saltwater-resistant, PUR, halogen-free 	LTG-2612-MW	6028516
	<ul style="list-style-type: none"> Description: Incremental, shielded, SSI Connection type head A: Female connector, M12, 8-pin, straight, A-coded Signal type: Incremental, SSI Cable: CAT5, CAT5e Connection systems: IDC quick connection Permitted cross-section: 0.14 mm² ... 0.34 mm² 	DOS-1208-GA01	6045001
	<ul style="list-style-type: none"> Description: HIPERFACE®, shielded, SSI, Incremental Connection type head A: Female connector, M23, 12-pin, straight, A-coded Signal type: HIPERFACE®, SSI, Incremental Connection systems: Solder connection 	DOS-2312-G	6027538
	<ul style="list-style-type: none"> Description: HIPERFACE®, shielded, SSI, Incremental Connection type head A: Female connector, M23, 12-pin, straight, A-coded Signal type: HIPERFACE®, SSI, Incremental Connection systems: Solder connection 	DOS-2312-G02	2077057
	<ul style="list-style-type: none"> Description: HIPERFACE®, shielded, SSI, Incremental Connection type head A: Female connector, M23, 12-pin, angled, A-coded Signal type: HIPERFACE®, SSI, Incremental Connection systems: Solder connection 	DOS-2312-W01	2072580
	<ul style="list-style-type: none"> Description: Incremental, shielded Connection type head A: Male connector, M12, 8-pin, straight, A-coded Signal type: Incremental Cable: CAT5, CAT5e Connection systems: IDC quick connection Permitted cross-section: 0.14 mm² ... 0.34 mm² 	STE-1208-GA01	6044892
	<ul style="list-style-type: none"> Description: HIPERFACE®, shielded, SSI, Incremental, RS-422 Connection type head A: Male connector, M23, 12-pin, straight, A-coded Signal type: HIPERFACE®, SSI, Incremental, RS-422 Connection systems: Solder connection 	STE-2312-G	6027537
	<ul style="list-style-type: none"> Description: HIPERFACE®, shielded, SSI, Incremental Connection type head A: Male connector, M23, 12-pin, straight, A-coded Signal type: HIPERFACE®, SSI, Incremental 	STE-2312-GX	6028548

	Brief description	Type	part no.
	<ul style="list-style-type: none"> • Connection systems: Solder connection • Description: HIPERFACE[®], shielded, SSI, Incremental • Connection type head A: Male connector, M23, 12-pin, straight, A-coded • Signal type: HIPERFACE[®], SSI, Incremental • Connection systems: Solder connection 	STE-2312-G01	2077273
	<ul style="list-style-type: none"> • Description: Incremental, shielded • Connection type head A: Female connector, JST, 8-pin, straight • Connection type head B: Male connector, M23, 12-pin, straight • Signal type: Incremental • Cable: 0.35 m, 8-wire, PUR, halogen-free 	STL-2312-GM35AA3	2061621
	<ul style="list-style-type: none"> • Description: Incremental, shielded • Connection type head A: Female connector, JST, 8-pin, straight • Connection type head B: Male connector, M23, 12-pin, straight • Signal type: Incremental • Cable: 1 m, 8-wire, PUR, halogen-free 	STL-2312-G01MAA3	2061622
	<ul style="list-style-type: none"> • Description: Incremental, shielded • Connection type head A: Female connector, JST, 8-pin, straight • Connection type head B: Male connector, M23, 12-pin, straight • Signal type: Incremental • Cable: 2 m, 8-wire, PUR, halogen-free 	STL-2312-G02MAA3	2061504

SICK AT A GLANCE

SICK is one of the leading manufacturers of intelligent sensors and sensor solutions for industrial applications. A unique range of products and services creates the perfect basis for controlling processes securely and efficiently, protecting individuals from accidents and preventing damage to the environment.

We have extensive experience in a wide range of industries and understand their processes and requirements. With intelligent sensors, we can deliver exactly what our customers need. In application centers in Europe, Asia and North America, system solutions are tested and optimized in accordance with customer specifications. All this makes us a reliable supplier and development partner.

Comprehensive services complete our offering: SICK LifeTime Services provide support throughout the machine life cycle and ensure safety and productivity.

For us, that is “Sensor Intelligence.”

WORLDWIDE PRESENCE:

Contacts and other locations –www.sick.com