



WTB12C-3P2432A91

W12

PHOTOELECTRIC SENSORS

SICK
Sensor Intelligence.



Illustration may differ

Ordering information

Type	part no.
WTB12C-3P2432A91	1060222

Other models and accessories → www.sick.com/W12



Detailed technical data

Features

Functional principle	Photoelectric proximity sensor	
Functional principle detail	Background suppression	
Sensing range max.	20 mm ... 350 mm ¹⁾	
Sensing range	20 mm ... 350 mm ¹⁾	
Emitted beam	Light source	PinPoint LED ²⁾
	Type of light	Visible red light
	Light spot size (distance)	Ø 6 mm (200 mm)
Key LED figures	Wave length	640 nm
	Adjustment	IO-Link, Single teach-in button
Pin 2 configuration	External input, Teach-in input, Sender off input, Detection output, logic output	

¹⁾ Object with 90% remission (based on standard white, DIN 5033).

²⁾ Average service life: 50,000 h at T_U = +25 °C.

Safety-related parameters

MTTF_D	634 years
DC_{avg}	0 %
T_M (mission time)	20 years

Communication interface

IO-Link	✓ , COM2 (38,4 kBaud)
Data transmission rate	COM2 (38,4 kBaud)
Cycle time	2.3 ms
Process data length	16 Bit
Process data structure	Bit 0 = switching signal Q _{L1}
	Bit 1 = switching signal Q _{L2}
	Bit 2 ... 15 = measuring value
VendorID	26
DeviceID HEX	0x8000ED
DeviceID DEC	8388845

Electronics

Supply voltage U_B	10 V DC ... 30 V DC ¹⁾
Ripple	< 5 V _{pp} ²⁾
Current consumption	45 mA ³⁾
Protection class	III
Digital output	
Type	PNP ⁴⁾
Switching mode	Light/dark switching
Signal voltage PNP HIGH/LOW	> U _v - 2,5 V / ca. 0 V
Output current I _{max.}	≤ 100 mA
Response time	⁵⁾
Repeatability (response time)	100 μs ⁶⁾
Switching frequency	1,500 Hz ⁷⁾
Circuit protection	A ⁸⁾ B ⁹⁾ C ¹⁰⁾ D ¹¹⁾
Response time Q/ on Pin 2	200 μs ... 300 μs ^{5) 6)}
Switching frequency Q / to pin 2	≤ 1,500 Hz ¹²⁾

¹⁾ Limit values when operated in short-circuit protected network: max. 8 A.

²⁾ May not fall below or exceed U_v tolerances.

³⁾ Without load.

⁴⁾ Pin 4: This switching output must not be connected to another output.

⁵⁾ Signal transit time with resistive load.

⁶⁾ Valid for Q \ on Pin2, if configured with software.

⁷⁾ With light/dark ratio 1:1.

⁸⁾ A = V_S connections reverse-polarity protected.

⁹⁾ B = inputs and output reverse-polarity protected.

¹⁰⁾ C = interference suppression.

¹¹⁾ D = outputs overcurrent and short-circuit protected.

¹²⁾ With light / dark ratio 1:1, valid for Q \ on Pin2, if configured with software.

Mechanics

Housing	Rectangular
----------------	-------------

Dimensions (W x H x D)	15.6 mm x 48.5 mm x 42 mm
Connection	Male connector M12, 4-pin
Material	
	Housing Metal, zinc diecast
	Front screen Plastic, PMMA
Weight	120 g

Ambient data

Enclosure rating	IP66 IP67
Ambient operating temperature	-40 °C ... +60 °C
Ambient temperature, storage	-40 °C ... +75 °C
UL File No.	NRKH.E181493 & NRKH7.E181493

Smart Task

Smart Task name	Timestamp + debouncing
Logic function	Direct AND OR WINDOW Hysteresis
Timer function	Deactivated Switch-on delay Off delay ON and OFF delay Impulse (one shot)
Inverter	Yes
Response time	SIO Direct: 200 µs ... 300 µs ¹⁾ SIO Logic: 700 µs ... 800 µs ²⁾ IOL: --- ³⁾
Repeatability	SIO Direct: 100 µs ¹⁾ SIO Logic: 100 µs ²⁾ IOL: --- ³⁾
Time stamp accuracy	SIO Direct: --- SIO Logic: --- IOL: - 70 ... + 320 µs
Min. Time between two process events (switches)	SIO Direct: 300 µs SIO Logic: 500 µs IOL: 700 ms
Time stamp number buffer	SIO Direct: --- SIO Logic: --- IOL: 8
Max. TimeStamp Range	SIO Direct: --- SIO Logic: --- IOL: 260 ms
Debounce time max.	SIO Direct: --- SIO Logic: 52 ms IOL: 52 ms

¹⁾ SIO Direct: sensor operation in standard I/O mode without IO-Link communication and without using internal sensor logic or time parameters (set to "direct"/"deactivated").

²⁾ SIO Logic: Sensor operation in standard I/O mode without IO-Link communication. Sensor-internal logic or timing parameters plus Automation Functions used.

³⁾ IOL: Sensor operation with full IO-Link communication and usage of logic, timing and Automation Function parameters.

Switching signal	Switching signal Q _{L1}	Switching output
	Switching signal Q _{L2}	Switching output
Measuring value	Timestamp	

¹⁾ SIO Direct: sensor operation in standard I/O mode without IO-Link communication and without using internal sensor logic or time parameters (set to "direct"/"deactivated").

²⁾ SIO Logic: Sensor operation in standard I/O mode without IO-Link communication. Sensor-internal logic or timing parameters plus Automation Functions used.

³⁾ IOL: Sensor operation with full IO-Link communication and usage of logic, timing and Automation Function parameters.

Diagnosis

Device status	Yes
----------------------	-----

Certificates

EU declaration of conformity	✓
UK declaration of conformity	✓
ACMA declaration of conformity	✓
Moroccan declaration of conformity	✓
China RoHS	✓
ECOLAB certificate	✓
cULus certificate	✓
IO-Link certificate	✓
Photobiological safety (DIN EN 62471) certificate	✓
Information according to Art. 3 of Data Act (Regulation EU 2023/2854)	✓

Classifications

ECLASS 5.0	27270904
ECLASS 5.1.4	27270904
ECLASS 6.0	27270904
ECLASS 6.2	27270904
ECLASS 7.0	27270904
ECLASS 8.0	27270904
ECLASS 8.1	27270904
ECLASS 9.0	27270904
ECLASS 10.0	27270904
ECLASS 11.0	27270904
ECLASS 12.0	27270903
ETIM 5.0	EC002719
ETIM 6.0	EC002719
ETIM 7.0	EC002719
ETIM 8.0	EC002719
UNSPSC 16.0901	39121528

Dimensional drawing WTB12-3, IO-Link

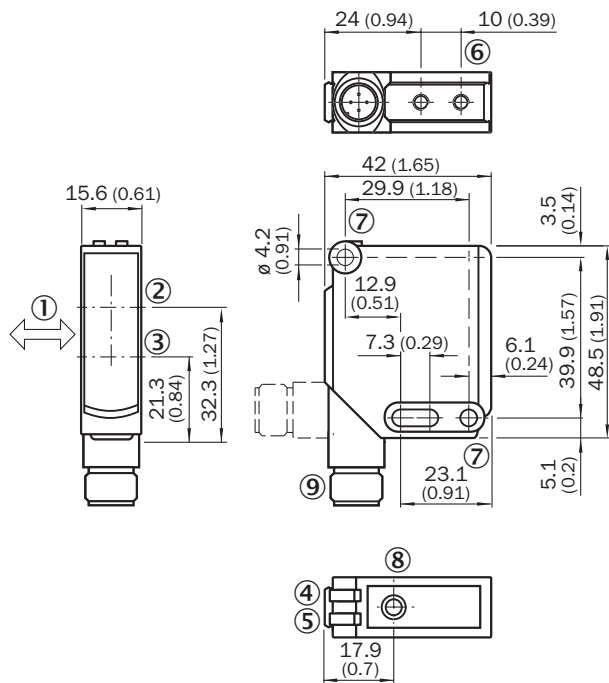

Dimensions in mm (inch)

- ① Standard direction of the material being detected
- ② Optical axis, receiver
- ③ Optical axis, sender
- ④ LED indicator green: Supply voltage active
- ⑤ LED indicator yellow: Status of received light beam
- ⑥ M4 threaded mounting hole, 4 mm deep
- ⑦ Mounting hole, \varnothing 4.2 mm
- ⑧ Adjustment sensing range: single teach-in button
- ⑨ Connection

Adjustments

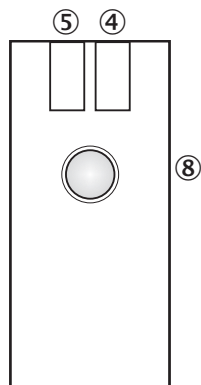

- ④ LED indicator green: Supply voltage active
- ⑤ LED indicator yellow: Status of received light beam
- ⑧ Adjustment sensing range: single teach-in button

Connection type

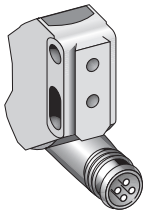



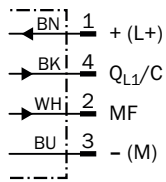



Connection diagram Cd-367



Recommended accessories

Other models and accessories → www.sick.com/W12

	Brief description	Type	part no.
Mounting systems			
	<ul style="list-style-type: none"> Description: Mounting bracket, large Material: Stainless steel Details: Stainless steel Items supplied: Mounting hardware included Suitable for: W11-2, W12-3, W16 	BEF-WG-W12	2013942
	<ul style="list-style-type: none"> Description: Plate N11N for universal clamp bracket Material: Stainless steel Details: Stainless steel 1.4571 (sheet), Stainless steel 1.4408 (clamp) Items supplied: Universal clamp (5322627), mounting hardware Usable for: DeltaPac, Glare, WTD20E 	BEF-KHS-N11N	2071081
network devices			
		IOLA2US-01101 (SiLink2 Master)	1061790

	Brief description	Type	part no.
connectors and cables			
	<ul style="list-style-type: none"> • Description: Sensor/actuator cable, unshielded • Connection type head A: Female connector, M12, 4-pin, straight, A-coded • Connection type head B: Flying leads • Signal type: Sensor/actuator cable • Cable: 5 m, 4-wire, PVC • Application: Uncontaminated zones, Zones with chemicals 	YF2A14-050VB3XLEAX	2096235
	<ul style="list-style-type: none"> • Description: Sensor/actuator cable, unshielded • Connection type head A: Female connector, M12, 4-pin, straight, A-coded • Connection type head B: Flying leads • Signal type: Sensor/actuator cable • Cable: 5 m, 4-wire, PUR, halogen-free • Application: Drag chain operation, Zones with oils and lubricants, Robot, Drag chain operation 	YF2A14-050UB3XLEAX	2095608
	<ul style="list-style-type: none"> • Description: Unshielded • Connection type head A: Male connector, M12, 4-pin, straight, A-coded • Connection systems: Screw-type terminals • Permitted cross-section: ≤ 0.75 mm² 	STE-1204-G	6009932

SICK AT A GLANCE

SICK is one of the leading manufacturers of intelligent sensors and sensor solutions for industrial applications. A unique range of products and services creates the perfect basis for controlling processes securely and efficiently, protecting individuals from accidents and preventing damage to the environment.

We have extensive experience in a wide range of industries and understand their processes and requirements. With intelligent sensors, we can deliver exactly what our customers need. In application centers in Europe, Asia and North America, system solutions are tested and optimized in accordance with customer specifications. All this makes us a reliable supplier and development partner.

Comprehensive services complete our offering: SICK LifeTime Services provide support throughout the machine life cycle and ensure safety and productivity.

For us, that is “Sensor Intelligence.”

WORLDWIDE PRESENCE:

Contacts and other locations –www.sick.com