



GRTE18S-N2342

GR18

PHOTOELECTRIC SENSORS

SICK
Sensor Intelligence.



Illustration may differ



Ordering information

Type	part no.
GRTE18S-N2342	1059482

Other models and accessories → www.sick.com/GR18

Detailed technical data

Features

Functional principle	Photoelectric proximity sensor
Functional principle detail	Energetic
Dimensions (W x H x D)	18 mm x 18 mm x 38.1 mm
Housing design (light emission)	Cylindrical
Thread diameter (housing)	M18 x 1
Optical axis	Axial
Sensing range max.	5 mm ... 550 mm ¹⁾
Sensing range	10 mm ... 400 mm ¹⁾
Type of light	Visible red light
Light source	PinPoint LED ²⁾
Light spot size (distance)	Ø 9 mm (400 mm)
Wave length	650 nm
Adjustment	Potentiometer, 270°
Display	
	LED green
	Operating indicator Static on: power on
	LED yellow
	Status of received light beam Static on: object present Static off: object not present

¹⁾ Object with 90% remission (based on standard white, DIN 5033).

²⁾ Average service life: 100,000 h at T_U = +25 °C.

Mechanics/electronics

Supply voltage U_B	10 V DC ... 30 V DC ¹⁾
Ripple	< 5 V _{pp} ²⁾
Current consumption	30 mA
Switching output	NPN
Switching mode	Light switching
Signal voltage NPN HIGH/LOW	Approx. $V_S / \leq 3$ V
Output current I_{max}	≤ 100 mA ³⁾
Response time	< 1,000 μ s ⁴⁾
Switching frequency	500 Hz ⁵⁾
Connection type	Connector M12, 3-pin
Circuit protection	A ⁶⁾ B ⁷⁾ D ⁸⁾
Protection class	III
Housing material	Metal, Nickel-plated brass and ABS
Optics material	Plastic, PMMA
Enclosure rating	IP67
Items supplied	Fastening nuts (2 x)
Electromagnetic compatibility (EMC)	EN 60947-5-2
Ambient operating temperature	-25 °C ... +55 °C ⁹⁾
Ambient temperature, storage	-40 °C ... +70 °C
UL File No.	NRKH.E348498 & NRKH7.E348498

¹⁾ Limit values. Operated in short-circuit protected network: max. 8 A.

²⁾ May not fall below or exceed U_V tolerances.

³⁾ At $U_V > 24$ V or ambient temperature > 49 °C, I_A max. = 50 mA.

⁴⁾ Signal transit time with resistive load.

⁵⁾ With light/dark ratio 1:1.

⁶⁾ A = V_S connections reverse-polarity protected.

⁷⁾ B = inputs and output reverse-polarity protected.

⁸⁾ D = outputs overcurrent and short-circuit protected.

⁹⁾ At $U_V \leq 24$ V and $I_A < 50$ mA.

Certificates

EU declaration of conformity	✓
UK declaration of conformity	✓
ACMA declaration of conformity	✓
Moroccan declaration of conformity	✓
China RoHS	✓
ECOLAB certificate	✓
cULus certificate	✓
Photobiological safety (DIN EN 62471) certificate	✓

Classifications

ECLASS 5.0	27270903
ECLASS 5.1.4	27270903
ECLASS 6.0	27270903
ECLASS 6.2	27270903
ECLASS 7.0	27270903
ECLASS 8.0	27270903
ECLASS 8.1	27270903
ECLASS 9.0	27270903
ECLASS 10.0	27270904
ECLASS 11.0	27270904
ECLASS 12.0	27270903
ETIM 5.0	EC001821
ETIM 6.0	EC001821
ETIM 7.0	EC002719
ETIM 8.0	EC002719
UNSPSC 16.0901	39121528

Adjustments GRTB18(S), GRTE18(S), Sensing range setting: Potentiometer, 270°

Sensing range

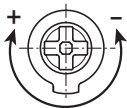

Connection type

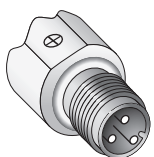

Connection diagram Cd-045



Characteristic curve GRTE18S, 400 mm

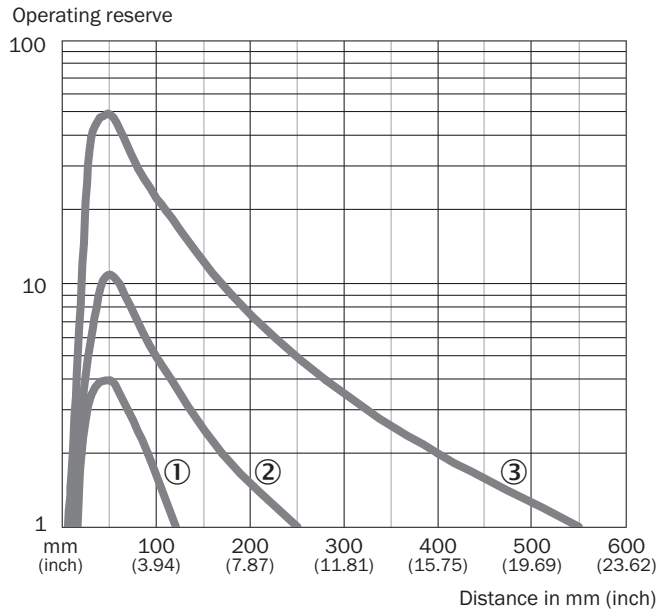

- ① Sensing range on black, 6% remission factor
- ② sensing range to gray, 20% remission factor
- ③ Sensing range on white, 90% remission factor

Light spot size GRTE18S, 400 mm

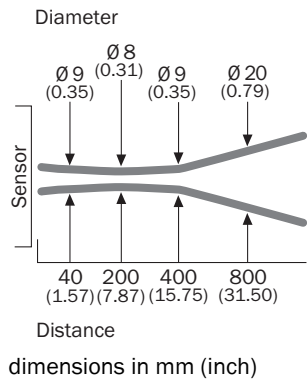

Sensing range diagram GRTE18S, 400 mm

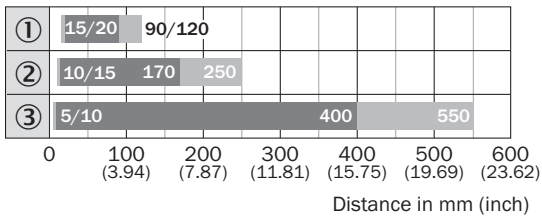

- Sensing range ■ Sensing range max.
- ① Sensing range on black, 6% remission factor
- ② sensing range to gray, 20% remission factor
- ③ Sensing range on white, 90% remission factor

Response range GRTE18S, 400 mm

Parallel operating range y in mm (inch)

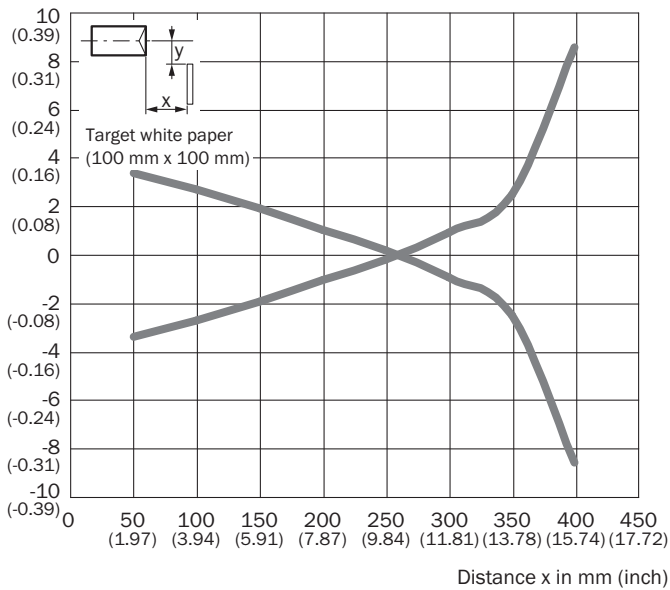

Dimensional drawing GR18S, metal, connector, straight, adjustable

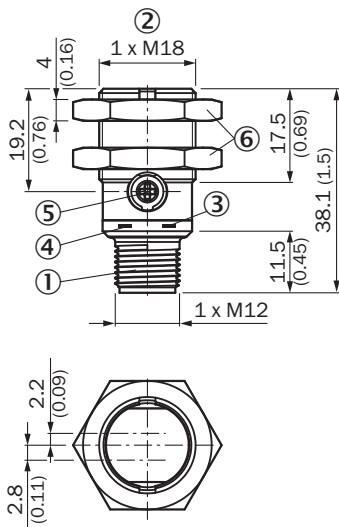



Dimensions in mm (inch)

- ① Connector M12, 3-pin
- ② Threaded mounting hole M18 x 1
- ③ LED indicator yellow
- ④ LED indicator green
- ⑤ sensitivity control: potentiometer 270°
- ⑥ Fastening nuts (2x); width across 24, metal

Recommended accessories

Other models and accessories → www.sick.com/GR18

	Brief description	Type	part no.
Mounting systems			
	<ul style="list-style-type: none"> • Description: Mounting bracket for M18 sensors • Material: Steel • Details: Steel, zinc coated • Items supplied: Without mounting hardware • Suitable for: GR18, V180-2, V18, W15, Z1, Z2 	BEF-WN-M18	5308446
connectors and cables			
	<ul style="list-style-type: none"> • Description: Sensor/actuator cable, unshielded • Connection type head A: Female connector, M12, 3-pin, straight, A-coded • Connection type head B: Flying leads • Signal type: Sensor/actuator cable • Cable: 5 m, 3-wire, PUR, halogen-free • Application: Drag chain operation, Zones with oils and lubricants, Robot, Drag chain operation 	YF2A13-050UB1XLEAX	2095605

SICK AT A GLANCE

SICK is one of the leading manufacturers of intelligent sensors and sensor solutions for industrial applications. A unique range of products and services creates the perfect basis for controlling processes securely and efficiently, protecting individuals from accidents and preventing damage to the environment.

We have extensive experience in a wide range of industries and understand their processes and requirements. With intelligent sensors, we can deliver exactly what our customers need. In application centers in Europe, Asia and North America, system solutions are tested and optimized in accordance with customer specifications. All this makes us a reliable supplier and development partner.

Comprehensive services complete our offering: SICK LifeTime Services provide support throughout the machine life cycle and ensure safety and productivity.

For us, that is “Sensor Intelligence.”

WORLDWIDE PRESENCE:

Contacts and other locations –www.sick.com