



# MPA-287THTU0

MPA

CYLINDER SENSORS

**SICK**  
Sensor Intelligence.



### Ordering information

Type	part no.
MPA-287THTU0	1059453

Other models and accessories → [www.sick.com/MPA](http://www.sick.com/MPA)



### Detailed technical data

#### Features

<b>Cylinder type</b>	Universal
<b>Cylinder types with adapter</b>	Round body cylinder Tie rod cylinder T-slot cylinders Festo cylinders DSBC SMC cylinders CP96
<b>Measuring range</b>	287 mm <sup>1)</sup>
<b>Housing length</b>	289 mm
<b>Output function</b>	Analog, IO-Link
<b>Electrical wiring</b>	DC 4-wire
<b>Analog output (voltage)</b>	0 V ... 10 V
<b>Analog output (current)</b>	4 mA ... 20 mA <sup>2)</sup>
<b>Enclosure rating</b>	IP65 <sup>3)</sup> IP67 IP68
<b>Adjustment</b>	
Teach-in control panel	Teaching in the measuring range Selecting the current/voltage output or IO-Link Resetting the measuring range to factory settings
IO-Link	Teaching in the measuring range Resetting the measuring range
<b>IO-Link functions</b>	Standard functions

<sup>1)</sup> ± 1 mm.

<sup>2)</sup> Default setting: Current output active.

<sup>3)</sup> According to EN 60529.

Mechanics/electronics

<b>Supply voltage</b>	15 V DC ... 30 V DC
<b>Power consumption</b>	35 mA, without load
<b>Max. load resistance</b>	≤ 500 Ω Power Output, at 24 V
<b>Min. load resistance</b>	≥ 2 kΩ <sup>1)</sup>
<b>Protection class</b>	III
<b>Required magnetic field sensitivity, typ.</b>	2 mT ... 15 mT
<b>Resolution, typ.</b>	0.03 % FSR (max. ≥ 0.06 mm) <sup>2)</sup> <sup>3)</sup>
<b>Linearity error, typ.</b>	0.5 mm <sup>4)</sup>
<b>Repeat accuracy, typ.</b>	0.06 % FSR (≥ 0.1 mm) <sup>5)</sup>
<b>Sampling rate, typ.</b>	1.15 ms <sup>6)</sup>
<b>Reverse polarity protection</b>	Yes
<b>Short-circuit protection</b>	Yes
<b>Status indicator LED</b>	Yes
<b>Teach-in</b>	Yes
<b>Ambient operating temperature</b>	-20 °C ... +70 °C
<b>Shock and vibration resistance</b>	30 g, 11 ms/10 Hz ... 55 Hz, 1 mm
<b>EMC</b>	According to EN 60947-5-2 <sup>7)</sup>
<b>Connection type</b>	Cable, 4-wire, stripped, 2 m
<b>Connection type Detail</b>	
Deep-freeze property	Do not bend below 0 °C
Conductor cross section	0.08 mm <sup>2</sup>
Cable diameter	Ø 2.6 mm
Bending radius	With fixed installation > 5 x cable diameter For flexible use > 10 x cable diameter
Cable outlet	Axial
<b>Material</b>	
Housing	Metal, Aluminum Plastic
Cable	PUR
<b>UL File No.</b>	NRKH.E181493 & NRKH7.E181493

<sup>1)</sup> Voltage output.

<sup>2)</sup> FSR: Full Scale Range; max. measuring range.

<sup>3)</sup> When using IO-Link, the resolution is 0.25 mm.

<sup>4)</sup> At 25 °C, linearity error (maximum deviation) depending on response curve and minimal deviation function.

<sup>5)</sup> At 25 °C, repeatability magnet movement in one direction.

<sup>6)</sup> Only in standard mode, not in IO-Link mode.

<sup>7)</sup> The analog measured value can deviate under transient conditions.

Safety-related parameters

<b>MTTF<sub>D</sub></b>	172 years
<b>DC<sub>avg</sub></b>	0 %

<b>T<sub>M</sub> (mission time)</b>	20 years
-------------------------------------	----------

## Communication interface

<b>Communication interface</b>	IO-Link V1.0.1
<b>Communication Interface detail</b>	COM2
<b>Cycle time</b>	2.3 ms
<b>Process data length</b>	16 Bit
<b>Process data structure</b>	Bit 0 ... 3 = reserved Bit 4 ... 5 = position (after decimal point) Bit 6 ... 15 = position (before decimal point)

## Certificates

<b>EU declaration of conformity</b>	✓
<b>UK declaration of conformity</b>	✓
<b>ACMA declaration of conformity</b>	✓
<b>Moroccan declaration of conformity</b>	✓
<b>China RoHS</b>	✓
<b>cULus certificate</b>	✓
<b>IO-Link certificate</b>	✓
<b>Information according to Art. 3 of Data Act (Regulation EU 2023/2854)</b>	✓

## Classifications

<b>ECLASS 5.0</b>	27270104
<b>ECLASS 5.1.4</b>	27270104
<b>ECLASS 6.0</b>	27270104
<b>ECLASS 6.2</b>	27270104
<b>ECLASS 7.0</b>	27270104
<b>ECLASS 8.0</b>	27270104
<b>ECLASS 8.1</b>	27270104
<b>ECLASS 9.0</b>	27270104
<b>ECLASS 10.0</b>	27270104
<b>ECLASS 11.0</b>	27270104
<b>ECLASS 12.0</b>	27274301
<b>ETIM 5.0</b>	EC002544
<b>ETIM 6.0</b>	EC002544
<b>ETIM 7.0</b>	EC002544
<b>ETIM 8.0</b>	EC002544
<b>UNSPSC 16.0901</b>	39122230

Connection diagram Cd-354

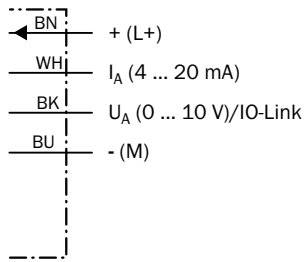

Dimensional drawing Cable

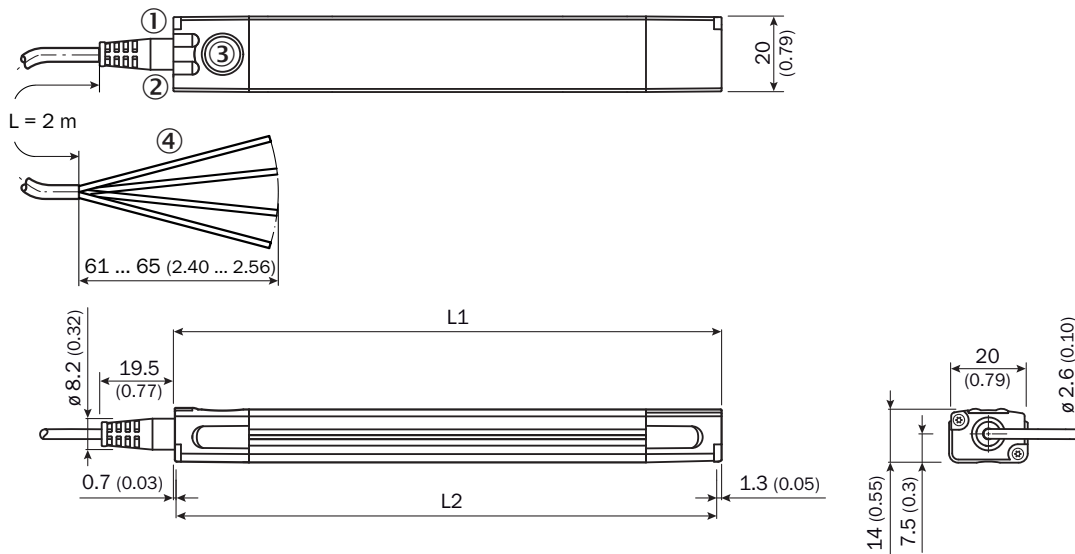

	Total length (L1) mm	Measuring range (L2) mm		Total length (L1) mm	Measuring range (L2) mm
<b>MPA-107</b>	109	107	<b>MPA-575</b>	577	575
<b>MPA-143</b>	145	143	<b>MPA-611</b>	613	611
<b>MPA-179</b>	181	179	<b>MPA-647</b>	649	647
<b>MPA-215</b>	217	215	<b>MPA-683</b>	685	683
<b>MPA-251</b>	253	251	<b>MPA-719</b>	721	719
<b>MPA-287</b>	289	287	<b>MPA-755</b>	757	755
<b>MPA-323</b>	325	323	<b>MPA-791</b>	793	791
<b>MPA-359</b>	361	359	<b>MPA-827</b>	829	827
<b>MPA-395</b>	397	395	<b>MPA-863</b>	865	863
<b>MPA-431</b>	433	431	<b>MPA-899</b>	901	899
<b>MPA-467</b>	469	467	<b>MPA-935</b>	937	935
<b>MPA-503</b>	505	503	<b>MPA-971</b>	973	971
<b>MPA-539</b>	541	539	<b>MPA-1007</b>	1,009	1,007

- Dimensions in mm (inch)
- ① Function signal indicator 1
  - ② Function signal indicator 2
  - ③ Teach-Pad
  - ④ Connection







## Recommended accessories

Other models and accessories → [www.sick.com/MPA](http://www.sick.com/MPA)

	Brief description	Type	part no.
<b>Mounting systems</b>			
	<ul style="list-style-type: none"> <li><b>Description:</b> For round body cylinders with diameter up to 85 mm</li> <li><b>Material:</b> Stainless steel</li> <li><b>Details:</b> Stainless steel V2A</li> <li><b>Usable for:</b> MPA-107 mm ... 359 mm (measuring range sensor), 2 (recommended number brackets), MPA-395 mm ... 647 mm (measuring range sensor), 3 (recommended number brackets), MPA-683 mm ... 935 mm (measuring range sensor), 4 (recommended number brackets), MPA-971 mm ... 1,007 mm (measuring range sensor), 5 (recommended number brackets)</li> </ul>	BEF-KHZR085MPA	2066626
	<ul style="list-style-type: none"> <li><b>Description:</b> For round body cylinders with diameter up to 135 mm</li> <li><b>Material:</b> Stainless steel</li> <li><b>Details:</b> Stainless steel V2A</li> <li><b>Usable for:</b> MPA-107 mm ... 359 mm (measuring range sensor), 2 (recommended number brackets), MPA-395 mm ... 647 mm (measuring range sensor), 3 (recommended number brackets), MPA-683 mm ... 935 mm (measuring range sensor), 4 (recommended number brackets), MPA-971 mm ... 1,007 mm (measuring range sensor), 5 (recommended number brackets)</li> </ul>	BEF-KHZR135MPA	2066627
	<ul style="list-style-type: none"> <li><b>Description:</b> For round body cylinders with diameter up to 210 mm</li> <li><b>Material:</b> Stainless steel</li> <li><b>Details:</b> Stainless steel V2A</li> <li><b>Usable for:</b> MPA-107 mm ... 359 mm (measuring range sensor), 2 (recommended number brackets), MPA-395 mm ... 647 mm (measuring range sensor), 3 (recommended number brackets), MPA-683 mm ... 935 mm (measuring range sensor), 4 (recommended number brackets), MPA-971 mm ... 1,007 mm (measuring range sensor), 5 (recommended number brackets)</li> </ul>	BEF-KHZR210MPA	2066628
	<ul style="list-style-type: none"> <li><b>Description:</b> For tie-rod cylinder (diameter tie-rod max. 18 mm)</li> <li><b>Material:</b> Aluminum, stainless steel</li> <li><b>Details:</b> Aluminum alloy (adapter), Stainless steel V2A (mounting-/fixing screw)</li> <li><b>Usable for:</b> MPA-107 mm ... 251 mm (sensor measuring range), 2 (recommended number of brackets), MPA-287 mm ... 431 mm (measuring range sensor), 3 (recommended number mounting brackets), MPA-467 mm ... 647 mm (measuring range sensor), 4 (recommended number mounting brackets), MPA-683 mm ... 791 mm (measuring range sensor), 5 (recommended number mounting brackets), MPA-827 mm ... 1007 mm (measuring range sensor), 6 (recommended number mounting brackets)</li> </ul>	BEF-KHZPZ1MPA	2065578
	<ul style="list-style-type: none"> <li><b>Description:</b> For T-slot cylinders</li> <li><b>Material:</b> Stainless steel, brass</li> <li><b>Details:</b> Stainless steel V2A (bracket/mounting screw), Brass (fixing screw/sliding nut)</li> <li><b>Usable for:</b> MPA-107 mm ... 251 mm (sensor measuring range), 2 (recommended number of brackets), MPA-287 mm ... 431 mm (measuring range sensor), 3 (recommended number mounting brackets), MPA-467 mm ... 647 mm (measuring range sensor), 4 (recommended number mounting brackets), MPA-683 mm ... 791 mm (measuring range sensor), 5 (recommended number mounting brackets), MPA-827 mm ... 1007 mm (measuring range sensor), 6 (recommended number mounting brackets)</li> </ul>	BEF-KHZT01MPA	2065575
	<ul style="list-style-type: none"> <li><b>Description:</b> Bracket for lateral mounting</li> <li><b>Material:</b> Stainless steel, brass</li> <li><b>Details:</b> Stainless steel V2A (bracket/mounting screw), Brass (fixing screw)</li> <li><b>Usable for:</b> MPA-107 mm ... 251 mm (sensor measuring range), 2 (recommended number of brackets), MPA-287 mm ... 431 mm (measuring range sensor), 3 (recommended number mounting brackets), MPA-467 mm ... 647 mm (measuring range sensor), 4 (recommended number mounting brackets), MPA-683 mm ... 791 mm (measuring range sensor), 5 (recommended number mounting brackets), MPA-827 mm ... 1007 mm (measuring range sensor), 6 (recommended number mounting brackets)</li> </ul>	BEF-WNZ01MPA	2065577
	<ul style="list-style-type: none"> <li><b>Description:</b> Bracket for low mounting</li> <li><b>Material:</b> Stainless steel, brass</li> <li><b>Details:</b> Stainless steel V2A (bracket/mounting screw), Brass (fixing screw)</li> <li><b>Usable for:</b> MPA-107 mm ... 251 mm (sensor measuring range), 2 (recommended number of brackets), MPA-287 mm ... 431 mm (measuring range sensor), 3 (recommended number mounting brackets), MPA-467 mm ... 647 mm (measuring range sensor), 4 (recommended number mounting brackets), MPA-683 mm ... 791 mm (measuring range sensor), 5 (recommended number mounting brackets), MPA-827 mm ... 1007 mm (measuring range sensor), 6 (recommended number mounting brackets)</li> </ul>	BEF-WNL01MPA	2065973
	<ul style="list-style-type: none"> <li><b>Description:</b> Sensor adapter DSBC-32</li> <li><b>Dimensions (W x H x L):</b> 10 mm x 16.9 mm x 43.4 mm</li> <li><b>Material:</b> Stainless steel</li> <li><b>Details:</b> Stainless steel V2A</li> <li><b>Usable for:</b> MPA-107 mm ... 251 mm (sensor measuring range), 2 (recommended number of brackets), MPA-287 mm ... 431 mm (measuring range sensor), 3 (recommended number mounting brackets), MPA-467 mm ... 647 mm (measuring range sensor), 4 (recommended number mounting brackets), MPA-683 mm ... 791 mm (measuring range sensor), 5 (recommended number mounting brackets)</li> </ul>	BEF-KHZPF032MPA	2086744

	Brief description	Type	part no.
	<p>mounting brackets), MPA-827 mm ... 1007 mm (measuring range sensor), 6 (recommended number mounting brackets)</p> <ul style="list-style-type: none"> <li><b>Description:</b> Sensor adapter DSBC-40</li> <li><b>Dimensions (W x H x L):</b> 10 mm x 16.9 mm x 48.9 mm</li> <li><b>Material:</b> Stainless steel</li> <li><b>Details:</b> Stainless steel V2A</li> <li><b>Usable for:</b> MPA-107 mm ... 251 mm (sensor measuring range), 2 (recommended number of brackets), MPA-287 mm ... 431 mm (measuring range sensor), 3 (recommended number mounting brackets), MPA-467 mm ... 647 mm (measuring range sensor), 4 (recommended number mounting brackets), MPA-683 mm ... 791 mm (measuring range sensor), 5 (recommended number mounting brackets), MPA-827 mm ... 1007 mm (measuring range sensor), 6 (recommended number mounting brackets)</li> </ul>	BEF-KHZPF040MPA	2086745
	<ul style="list-style-type: none"> <li><b>Description:</b> Sensor adapter DSBC-50</li> <li><b>Dimensions (W x H x L):</b> 10 mm x 16.9 mm x 51.7 mm</li> <li><b>Material:</b> Stainless steel</li> <li><b>Details:</b> Stainless steel V2A</li> <li><b>Usable for:</b> MPA-107 mm ... 251 mm (sensor measuring range), 2 (recommended number of brackets), MPA-287 mm ... 431 mm (measuring range sensor), 3 (recommended number mounting brackets), MPA-467 mm ... 647 mm (measuring range sensor), 4 (recommended number mounting brackets), MPA-683 mm ... 791 mm (measuring range sensor), 5 (recommended number mounting brackets), MPA-827 mm ... 1007 mm (measuring range sensor), 6 (recommended number mounting brackets)</li> </ul>	BEF-KHZPF050MPA	2086746
	<ul style="list-style-type: none"> <li><b>Description:</b> Sensor adapter DSBC-63</li> <li><b>Dimensions (W x H x L):</b> 10 mm x 16.9 mm x 53.1 mm</li> <li><b>Material:</b> Stainless steel</li> <li><b>Details:</b> Stainless steel V2A</li> <li><b>Usable for:</b> MPA-107 mm ... 251 mm (sensor measuring range), 2 (recommended number of brackets), MPA-287 mm ... 431 mm (measuring range sensor), 3 (recommended number mounting brackets), MPA-467 mm ... 647 mm (measuring range sensor), 4 (recommended number mounting brackets), MPA-683 mm ... 791 mm (measuring range sensor), 5 (recommended number mounting brackets), MPA-827 mm ... 1007 mm (measuring range sensor), 6 (recommended number mounting brackets)</li> </ul>	BEF-KHZPF063MPA	2086747
	<ul style="list-style-type: none"> <li><b>Description:</b> Sensor adapter DSBC-80</li> <li><b>Dimensions (W x H x L):</b> 10 mm x 16.9 mm x 58.4 mm</li> <li><b>Material:</b> Stainless steel</li> <li><b>Details:</b> Stainless steel V2A</li> <li><b>Usable for:</b> MPA-107 mm ... 251 mm (sensor measuring range), 2 (recommended number of brackets), MPA-287 mm ... 431 mm (measuring range sensor), 3 (recommended number mounting brackets), MPA-467 mm ... 647 mm (measuring range sensor), 4 (recommended number mounting brackets), MPA-683 mm ... 791 mm (measuring range sensor), 5 (recommended number mounting brackets), MPA-827 mm ... 1007 mm (measuring range sensor), 6 (recommended number mounting brackets)</li> </ul>	BEF-KHZPF080MPA	2086748
	<ul style="list-style-type: none"> <li><b>Description:</b> Sensor adapter DSBC-100</li> <li><b>Dimensions (W x H x L):</b> 10 mm x 17 mm x 59.8 mm</li> <li><b>Material:</b> Stainless steel</li> <li><b>Details:</b> Stainless steel V2A</li> <li><b>Usable for:</b> MPA-107 mm ... 251 mm (sensor measuring range), 2 (recommended number of brackets), MPA-287 mm ... 431 mm (measuring range sensor), 3 (recommended number mounting brackets), MPA-467 mm ... 647 mm (measuring range sensor), 4 (recommended number mounting brackets), MPA-683 mm ... 791 mm (measuring range sensor), 5 (recommended number mounting brackets), MPA-827 mm ... 1007 mm (measuring range sensor), 6 (recommended number mounting brackets)</li> </ul>	BEF-KHZPF100MPA	2086749
	<ul style="list-style-type: none"> <li><b>Description:</b> Sensor adapter DSBC-125</li> <li><b>Dimensions (W x H x L):</b> 10 mm x 22.5 mm x 63.7 mm</li> <li><b>Material:</b> Stainless steel</li> <li><b>Details:</b> Stainless steel V2A</li> <li><b>Usable for:</b> MPA-107 mm ... 251 mm (sensor measuring range), 2 (recommended number of brackets), MPA-287 mm ... 431 mm (measuring range sensor), 3 (recommended number mounting brackets), MPA-467 mm ... 647 mm (measuring range sensor), 4 (recommended number mounting brackets), MPA-683 mm ... 791 mm (measuring range sensor), 5 (recommended number mounting brackets), MPA-827 mm ... 1007 mm (measuring range sensor), 6 (recommended number mounting brackets)</li> </ul>	BEF-KHZPF125MPA	2086750
	<ul style="list-style-type: none"> <li><b>Description:</b> Sensor adapter CP96-63</li> <li><b>Dimensions (W x H x L):</b> 10 mm x 11.7 mm x 12.6 mm</li> <li><b>Material:</b> Stainless steel</li> <li><b>Details:</b> Stainless steel V2A</li> <li><b>Usable for:</b> MPA-107 mm ... 251 mm (sensor measuring range), 2 (recommended number of brackets), MPA-287 mm ... 431 mm (measuring range sensor), 3 (recommended number mounting brackets), MPA-467 mm ... 647 mm (measuring range sensor), 4 (recommended number mounting brackets), MPA-683 mm ... 791 mm (measuring range sensor), 5 (recommended number mounting brackets)</li> </ul>	BEF-KHZTS063MPA	2086756

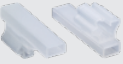

	Brief description	Type	part no.
	mounting brackets), MPA-827 mm ... 1007 mm (measuring range sensor), 6 (recommended number mounting brackets)		
	<ul style="list-style-type: none"> <li>• <b>Description:</b> Sensor adapter CP96-80</li> <li>• <b>Dimensions (W x H x L):</b> 10 mm x 13.7 mm x 14.8 mm</li> <li>• <b>Material:</b> Stainless steel</li> <li>• <b>Details:</b> Stainless steel V2A</li> <li>• <b>Usable for:</b> MPA-107 mm ... 251 mm (sensor measuring range), 2 (recommended number of brackets), MPA-287 mm ... 431 mm (measuring range sensor), 3 (recommended number mounting brackets), MPA-467 mm ... 647 mm (measuring range sensor), 4 (recommended number mounting brackets), MPA-683 mm ... 791 mm (measuring range sensor), 5 (recommended number mounting brackets), MPA-827 mm ... 1007 mm (measuring range sensor), 6 (recommended number mounting brackets)</li> </ul>	BEF-KHZTS080MPA	2086757
	<ul style="list-style-type: none"> <li>• <b>Description:</b> Sensor adapter CP96-100</li> <li>• <b>Dimensions (W x H x L):</b> 10 mm x 12.9 mm x 14.8 mm</li> <li>• <b>Material:</b> Stainless steel</li> <li>• <b>Details:</b> Stainless steel V2A</li> <li>• <b>Usable for:</b> MPA-107 mm ... 251 mm (sensor measuring range), 2 (recommended number of brackets), MPA-287 mm ... 431 mm (measuring range sensor), 3 (recommended number mounting brackets), MPA-467 mm ... 647 mm (measuring range sensor), 4 (recommended number mounting brackets), MPA-683 mm ... 791 mm (measuring range sensor), 5 (recommended number mounting brackets), MPA-827 mm ... 1007 mm (measuring range sensor), 6 (recommended number mounting brackets)</li> </ul>	BEF-KHZTS100MPA	2086758
	<ul style="list-style-type: none"> <li>• <b>Description:</b> Sensor adapter CP96-125</li> <li>• <b>Dimensions (W x H x L):</b> 10 mm x 12.2 mm x 14.6 mm</li> <li>• <b>Material:</b> Stainless steel</li> <li>• <b>Details:</b> Stainless steel V2A</li> <li>• <b>Usable for:</b> MPA-107 mm ... 251 mm (sensor measuring range), 2 (recommended number of brackets), MPA-287 mm ... 431 mm (measuring range sensor), 3 (recommended number mounting brackets), MPA-467 mm ... 647 mm (measuring range sensor), 4 (recommended number mounting brackets), MPA-683 mm ... 791 mm (measuring range sensor), 5 (recommended number mounting brackets), MPA-827 mm ... 1007 mm (measuring range sensor), 6 (recommended number mounting brackets)</li> </ul>	BEF-KHZTS125MPA	2086759
	<ul style="list-style-type: none"> <li>• <b>Description:</b> Label Holder, 2.5 mm to 3.5 mm, 10 pcs.</li> <li>• <b>Material:</b> Plastic</li> <li>• <b>Details:</b> TPU</li> <li>• <b>Packing unit:</b> 10 pieces</li> </ul>	LABEL HOLDER	2086019
magnets			
	<ul style="list-style-type: none"> <li>• <b>Product segment:</b> Magnets</li> <li>• <b>Product:</b> Position magnets</li> <li>• <b>Description:</b> Magnet with mounting hole for M3 countersunk screw, Ø 15.2 mm, height 6 mm</li> <li>• <b>Material:</b> Hard ferrite</li> </ul>	Magnet	5327349

## SICK AT A GLANCE

SICK is one of the leading manufacturers of intelligent sensors and sensor solutions for industrial applications. A unique range of products and services creates the perfect basis for controlling processes securely and efficiently, protecting individuals from accidents and preventing damage to the environment.

We have extensive experience in a wide range of industries and understand their processes and requirements. With intelligent sensors, we can deliver exactly what our customers need. In application centers in Europe, Asia and North America, system solutions are tested and optimized in accordance with customer specifications. All this makes us a reliable supplier and development partner.

Comprehensive services complete our offering: SICK LifeTime Services provide support throughout the machine life cycle and ensure safety and productivity.

For us, that is “Sensor Intelligence.”

## WORLDWIDE PRESENCE:

Contacts and other locations –[www.sick.com](http://www.sick.com)