



WL4SLG-3P5232H

W4

PHOTOELECTRIC SENSORS

SICK
Sensor Intelligence.



Ordering information

Type	part no.
WL4SLG-3P5232H	1058276

Other models and accessories → www.sick.com/W4

Illustration may differ



Detailed technical data

Features

Functional principle	Photoelectric retro-reflective sensor
Functional principle detail	Without reflector minimum distance (autocollimation/coaxial optics)
Sensing range max.	0 m ... 4.5 m ¹⁾ ²⁾
Sensing range	0 m ... 2 m ¹⁾ ²⁾
Polarisation filter	Yes
Emitted beam	
Light source	Laser ³⁾
Type of light	Visible red light
Light spot size (distance)	Ø 1 mm (500 mm)
Key laser figures	
Normative reference	EN 60825-1:2014, IEC 60825-1:2014 / CDRH 21 CFR 1040.10 & 1040.11
Laser class	1 ⁴⁾
Wave length	650 nm
Adjustment	Single teach-in button

¹⁾ Reflective tape REF-AC1000.

²⁾ To ensure reliable operation, we recommend using REF-AC1000 reflective tape or reflective-tap reflectors such as P41F, PLV14-A, PLH25-M12, or PLH25-D12. Reflectors with large-scale triple structures must only be used if deemed suitable for the application.

³⁾ Average service life: 50,000 h at T_U = +25 °C.

⁴⁾ Do not intentionally look into the laser beam. Never point the laser beam at people's eyes.

⁵⁾ Difference between standard/washdown and hygiene: The essential difference between a standard/washdown product and a hygiene product is that where the process and contact with the medium (activity in the vicinity of the food) are concerned, a hygiene product is designed in accordance with the latest standards and hygiene design guidelines, and materials are selected accordingly.

Special applications	Hygienic and washdown zones, Detecting transparent objects, Detecting small objects
Housing design	Hygiene ⁵⁾

1) Reflective tape REF-AC1000.

2) To ensure reliable operation, we recommend using REF-AC1000 reflective tape or reflective-tap reflectors such as P41F, PLV14-A, PLH25-M12, or PLH25-D12. Reflectors with large-scale triple structures must only be used if deemed suitable for the application.

3) Average service life: 50,000 h at $T_U = +25\text{ °C}$.

4) Do not intentionally look into the laser beam. Never point the laser beam at people's eyes.

5) Difference between standard/washdown and hygiene: The essential difference between a standard/washdown product and a hygiene product is that where the process and contact with the medium (activity in the vicinity of the food) are concerned, a hygiene product is designed in accordance with the latest standards and hygiene design guidelines, and materials are selected accordingly.

Safety-related parameters

MTTF_D	655 years (EN ISO 13849-1) ¹⁾
DC_{avg}	0 %

1) Mode of calculation: Parts-Count-calculation.

Electronics

Supply voltage U_B	10 V DC ... 30 V DC ¹⁾
Ripple	$< 5\text{ V}_{pp}$ ²⁾
Current consumption	30 mA ³⁾
Protection class	III
Digital output	
Type	PNP ⁴⁾
Switching mode	Light/dark switching ⁴⁾
Output current I_{max}	$\leq 100\text{ mA}$
Response time	$\leq 0.5\text{ ms}$ ⁵⁾
Switching frequency	1,000 Hz ⁶⁾
Output function	Complementary
Circuit protection	A ⁷⁾ B ⁸⁾ C ⁹⁾
Special feature	D12 adapter shaft

1) Limit values when operated in short-circuit protected network: max. 8 A.

2) May not fall below or exceed U_y tolerances.

3) Without load.

4) Q = light switching.

5) Signal transit time with resistive load.

6) With light/dark ratio 1:1.

7) A = V_S connections reverse-polarity protected.

8) B = inputs and output reverse-polarity protected.

9) C = interference suppression.

Mechanics

Housing	Rectangular
Design detail	Slim
Dimensions (W x H x D)	15.3 mm x 63.2 mm x 22.2 mm

1) Max. tightening torque: 0.6 Nm.

Connection	Male connector M8, 4-pin ¹⁾
Material	Housing: Metal, Stainless steel V4A (1.4404, 316L)
	Front screen: Plastic, PMMA
Weight	140 g

¹⁾ Max. tightening torque: 0.6 Nm.

Ambient data

Enclosure rating	IP66 IP67 IP68 IP69K ¹⁾
Ambient operating temperature	-10 °C ... +50 °C
Ambient operating temperature extended	-30 °C ... +55 °C ^{2) 3)}
Ambient temperature, storage	-30 °C ... +70 °C
RoHS certificate	✓

¹⁾ Only in case of correctly mounted IP69K connecting cable.

²⁾ As of $T_a = 50\text{ °C}$, a max. supply voltage $V_{max.} = 24\text{ V}$ and a max. load current $I_{max.} = 50\text{ mA}$ is permitted.

³⁾ Operation below $T_u - 10\text{ °C}$ is possible if the sensor is already switched on at $T_u > -10\text{ °C}$, then cools down, and the supply voltage is subsequently not switched off. Switching on below $T_u - 10\text{ °C}$ is not permissible.

Certificates

EU declaration of conformity	✓
UK declaration of conformity	✓
ACMA declaration of conformity	✓
Moroccan declaration of conformity	✓
China RoHS	✓
ECOLAB certificate	✓
Laser safety (IEC 60825-1) certificate	✓

Classifications

ECLASS 5.0	27270902
ECLASS 5.1.4	27270902
ECLASS 6.0	27270902
ECLASS 6.2	27270902
ECLASS 7.0	27270902
ECLASS 8.0	27270902
ECLASS 8.1	27270902
ECLASS 9.0	27270902
ECLASS 10.0	27270902
ECLASS 11.0	27270902
ECLASS 12.0	27270902
ETIM 5.0	EC002717
ETIM 6.0	EC002717
ETIM 7.0	EC002717

ETIM 8.0	EC002717
UNSPSC 16.0901	39121528

Connection diagram Cd-083

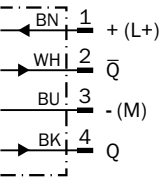

Characteristic curve

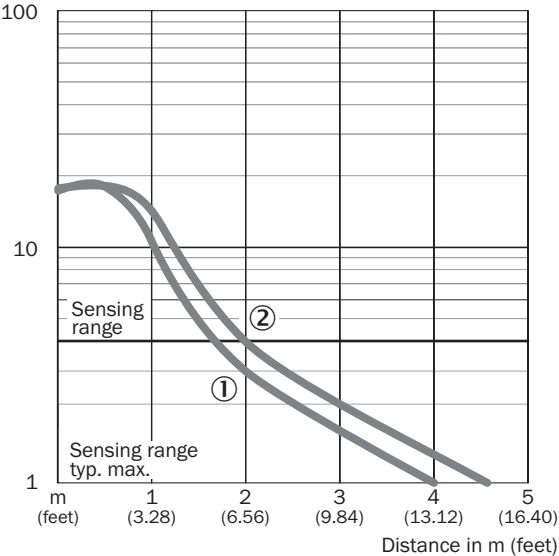

- ① Reflector PLV14-A / PLH25-M12 / PLH25-D12
- ② Reflector P41F / reflective tape REF-AC1000

Light spot size Overview

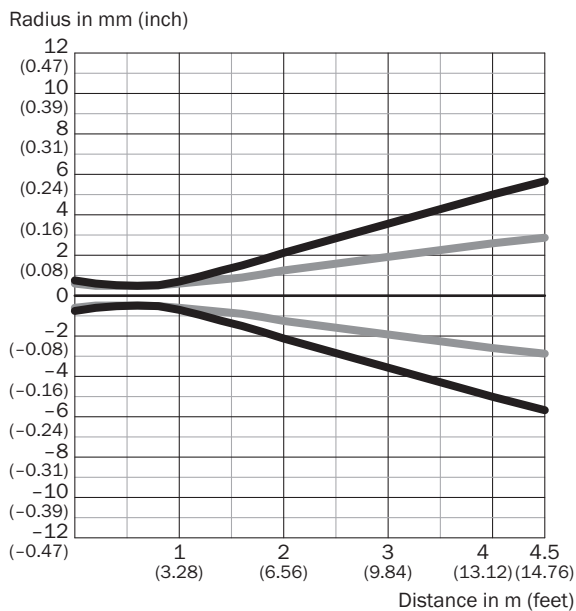

Dimensions in mm (inch)

Sensing range	Vertical	Horizontal
0.5 m (1.64 feet)	< 1.0 (0.04)	< 1.0 (0.04)
1 m (3.28 feet)	1.5 (0.06)	1.2 (0.05)
2 m (6.56 feet)	4.3 (0.17)	2.6 (0.10)
4.5 m (14.76 feet)	11.3 (0.44)	5.6 (0.22)

— Vertical
— Horizontal

Light spot size (detailed view)

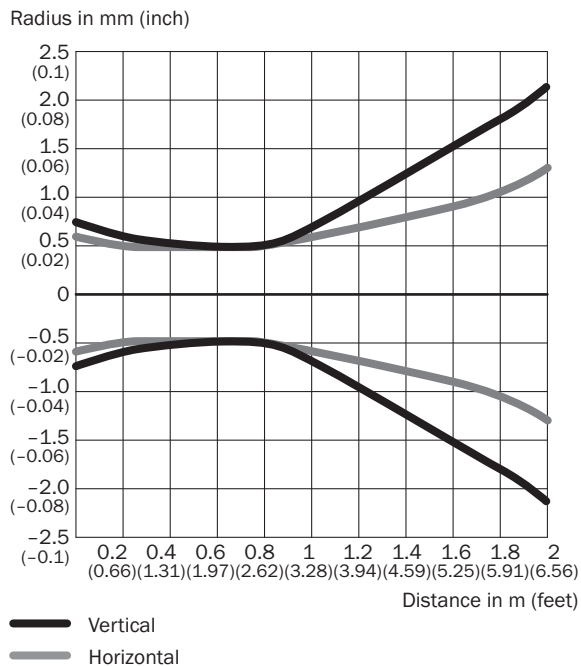

— Vertical
— Horizontal

Sensing range diagram

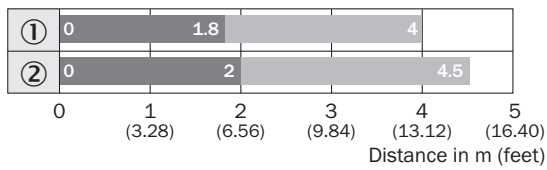

- Sensing range ■ Sensing range max.
- ① Reflector PLV14-A / PLH25-M12 / PLH25-D12
- ② Reflector P41F / reflective tape REF-AC1000

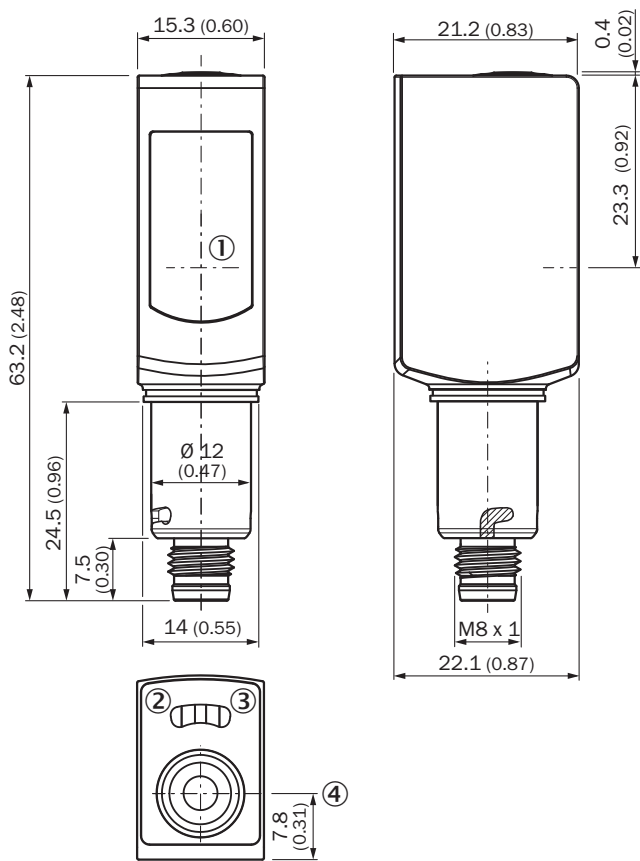

Dimensional drawing WTB4S-3H, WTF4S-3H, with single teach-in button, D12 adapter shaft, L-adaption



- Dimensions in mm (inch)
- ① Center of optical axis
 - ② LED indicator yellow: Status of received light beam
 - ③ LED indicator green: Supply voltage active
 - ④ single teach-in button

Recommended accessories

Other models and accessories → www.sick.com/W4

	Brief description	Type	part no.
reflectors and optics			
	<ul style="list-style-type: none"> Description: Stainless steel reflector, washdown design, chemically resistant, IP 69K enclosure rating, screw connection, PMMA front screens Dimensions: 14 mm Ambient operating temperature: -20 °C ... +60 °C 	PLV14-A	2063405
connectors and cables			
	<ul style="list-style-type: none"> Description: Sensor/actuator cable, unshielded Connection type head A: Female connector, M8, 4-pin, straight Connection type head B: Flying leads Signal type: Sensor/actuator cable Cable: 5 m, 4-wire, PP Connection systems: Flying leads Note: This product is generally resistant to chemical cleaning agents (see ECOLAB) and other chemical compounds such as H2O2 and CH2O2. Before permanent installation is carried out, the material's resistance to the cleaning agent being used must be checked., Resistant against lactic acid & hydrogen peroxide (H2O2) Application: Hygienic and washdown zones, Drag chain operation, Robot, cold bending resistant, seawater resistant 	DOL-0804-G05MRN	6058511
	<ul style="list-style-type: none"> Description: Sensor/actuator cable, unshielded Connection type head A: Female connector, M8, 4-pin, straight Connection type head B: Flying leads Signal type: Sensor/actuator cable Cable: 5 m, 4-wire, PVC Connection systems: Flying leads Note: This product is generally resistant to chemical cleaning agents (see ECOLAB). Please do not use cleaning agents of any other Kind., Not resistant against lactic acid & hydrogen peroxide (H2O2) Application: Uncontaminated zones, Hygienic and washdown zones, Zones with chemicals 	YF8U54-050VA3XLEAX	6059194

SICK AT A GLANCE

SICK is one of the leading manufacturers of intelligent sensors and sensor solutions for industrial applications. A unique range of products and services creates the perfect basis for controlling processes securely and efficiently, protecting individuals from accidents and preventing damage to the environment.

We have extensive experience in a wide range of industries and understand their processes and requirements. With intelligent sensors, we can deliver exactly what our customers need. In application centers in Europe, Asia and North America, system solutions are tested and optimized in accordance with customer specifications. All this makes us a reliable supplier and development partner.

Comprehensive services complete our offering: SICK LifeTime Services provide support throughout the machine life cycle and ensure safety and productivity.

For us, that is “Sensor Intelligence.”

WORLDWIDE PRESENCE:

Contacts and other locations –www.sick.com