



WL4SLG-3F2234V

W4

PHOTOELECTRIC SENSORS

**SICK**  
Sensor Intelligence.



Illustration may differ



### Ordering information

Type	part no.
WL4SLG-3F2234V	1058260

Other models and accessories → [www.sick.com/W4](http://www.sick.com/W4)

### Detailed technical data

#### Features

<b>Functional principle</b>	Photoelectric retro-reflective sensor
<b>Functional principle detail</b>	Without reflector minimum distance (autocollimation/coaxial optics)
<b>Sensing range max.</b>	0 m ... 4.5 m <sup>1)</sup> <sub>2)</sub>
<b>Sensing range</b>	0 m ... 2 m <sup>1)</sup> <sub>2)</sub>
<b>Polarisation filter</b>	Yes
<b>Emitted beam</b>	
Light source	Laser <sup>3)</sup>
Type of light	Visible red light
Light spot size (distance)	Ø 1 mm (500 mm)
<b>Key laser figures</b>	
Normative reference	EN 60825-1:2014, IEC 60825-1:2014 / CDRH 21 CFR 1040.10 & 1040.11
Laser class	1 <sup>4)</sup>
Wave length	650 nm

<sup>1)</sup> Reflective tape REF-AC1000.

<sup>2)</sup> To ensure reliable operation, we recommend using REF-AC1000 reflective tape or reflective-tap reflectors such as P41F, PLV14-A, PLH25-M12, or PLH25-D12. Reflectors with large-scale triple structures must only be used if deemed suitable for the application.

<sup>3)</sup> Average service life: 50,000 h at T<sub>U</sub> = +25 °C.

<sup>4)</sup> Do not intentionally look into the laser beam. Never point the laser beam at people's eyes.

<sup>5)</sup> Adjustment via cable (ET): white cable or PIN2 according to the desired sensitivity > 2 ... < 8 s or put > 8 s on L+ (PNP) or on M (NPN).

<sup>6)</sup> Difference between standard/washdown and hygiene: The essential difference between a standard/washdown product and a hygiene product is that where the process and contact with the medium (activity in the vicinity of the food) are concerned, a hygiene product is designed in accordance with the latest standards and hygiene design guidelines, and materials are selected accordingly.

<b>Adjustment</b>	Cable, Single teach-in button <sup>5)</sup>
<b>Special applications</b>	Hygienic and washdown zones, Detecting transparent objects, Detecting small objects
<b>Housing design</b>	Washdown <sup>6)</sup>
<b>Mounting hole</b>	M3

<sup>1)</sup> Reflective tape REF-AC1000.

<sup>2)</sup> To ensure reliable operation, we recommend using REF-AC1000 reflective tape or reflective-tap reflectors such as P41F, PLV14-A, PLH25-M12, or PLH25-D12. Reflectors with large-scale triple structures must only be used if deemed suitable for the application.

<sup>3)</sup> Average service life: 50,000 h at  $T_U = +25$  °C.

<sup>4)</sup> Do not intentionally look into the laser beam. Never point the laser beam at people's eyes.

<sup>5)</sup> Adjustment via cable (ET): white cable or PIN2 according to the desired sensitivity  $> 2 \dots < 8$  s or put  $> 8$  s on L+ (PNP) or on M (NPN).

<sup>6)</sup> Difference between standard/washdown and hygiene: The essential difference between a standard/washdown product and a hygiene product is that where the process and contact with the medium (activity in the vicinity of the food) are concerned, a hygiene product is designed in accordance with the latest standards and hygiene design guidelines, and materials are selected accordingly.

## Safety-related parameters

<b>MTTF<sub>D</sub></b>	655 years (EN ISO 13849-1) <sup>1)</sup>
<b>DC<sub>avg</sub></b>	0 %

<sup>1)</sup> Mode of calculation: Parts-Count-calculation.

## Electronics

<b>Supply voltage U<sub>B</sub></b>	10 V DC ... 30 V DC <sup>1)</sup>
<b>Ripple</b>	$< 5 V_{pp}$ <sup>2)</sup>
<b>Current consumption</b>	30 mA <sup>3)</sup>
<b>Protection class</b>	III
<b>Digital output</b>	
Type	PNP
Switching mode	Dark switching
Output current I <sub>max</sub>	$\leq 100$ mA
Response time	$\leq 0.5$ ms <sup>4)</sup>
Switching frequency	1,000 Hz <sup>5)</sup>
<b>Circuit protection</b>	A <sup>6)</sup> B <sup>7)</sup> C <sup>8)</sup>

<sup>1)</sup> Limit values when operated in short-circuit protected network: max. 8 A.

<sup>2)</sup> May not fall below or exceed U<sub>y</sub> tolerances.

<sup>3)</sup> Without load.

<sup>4)</sup> Signal transit time with resistive load.

<sup>5)</sup> With light/dark ratio 1:1.

<sup>6)</sup> A = V<sub>S</sub> connections reverse-polarity protected.

<sup>7)</sup> B = inputs and output reverse-polarity protected.

<sup>8)</sup> C = interference suppression.

## Mechanics

<b>Housing</b>	Rectangular
<b>Design detail</b>	Slim
<b>Dimensions (W x H x D)</b>	15.3 mm x 55.4 mm x 22.2 mm

<sup>1)</sup> Max. tightening torque: 0.6 Nm.

<b>Connection</b>	Male connector M8, 4-pin <sup>1)</sup>
<b>Material</b>	Housing: Metal, Stainless steel V4A (1.4404, 316L)
	Front screen: Plastic, PMMA
<b>Weight</b>	40 g

<sup>1)</sup> Max. tightening torque: 0.6 Nm.

### Ambient data

<b>Enclosure rating</b>	IP66 IP67 IP68 IP69K <sup>1)</sup>
<b>Ambient operating temperature</b>	-10 °C ... +50 °C
<b>Ambient operating temperature extended</b>	-30 °C ... +55 °C <sup>2) 3)</sup>
<b>Ambient temperature, storage</b>	-30 °C ... +70 °C
<b>RoHS certificate</b>	✓

<sup>1)</sup> Only in case of correctly mounted IP69K connecting cable.

<sup>2)</sup> As of  $T_a = 50\text{ °C}$ , a max. supply voltage  $V_{max.} = 24\text{ V}$  and a max. load current  $I_{max.} = 50\text{ mA}$  is permitted.

<sup>3)</sup> Operation below  $T_u - 10\text{ °C}$  is possible if the sensor is already switched on at  $T_u > -10\text{ °C}$ , then cools down, and the supply voltage is subsequently not switched off. Switching on below  $T_u - 10\text{ °C}$  is not permissible.

### Certificates

<b>EU declaration of conformity</b>	✓
<b>UK declaration of conformity</b>	✓
<b>ACMA declaration of conformity</b>	✓
<b>Moroccan declaration of conformity</b>	✓
<b>China RoHS</b>	✓
<b>ECOLAB certificate</b>	✓
<b>Laser safety (IEC 60825-1) certificate</b>	✓

### Classifications

<b>ECLASS 5.0</b>	27270902
<b>ECLASS 5.1.4</b>	27270902
<b>ECLASS 6.0</b>	27270902
<b>ECLASS 6.2</b>	27270902
<b>ECLASS 7.0</b>	27270902
<b>ECLASS 8.0</b>	27270902
<b>ECLASS 8.1</b>	27270902
<b>ECLASS 9.0</b>	27270902
<b>ECLASS 10.0</b>	27270902
<b>ECLASS 11.0</b>	27270902
<b>ECLASS 12.0</b>	27270902
<b>ETIM 5.0</b>	EC002717
<b>ETIM 6.0</b>	EC002717
<b>ETIM 7.0</b>	EC002717

<b>ETIM 8.0</b>	EC002717
<b>UNSPSC 16.0901</b>	39121528

Connection diagram Cd-195

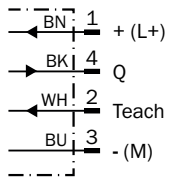

Characteristic curve

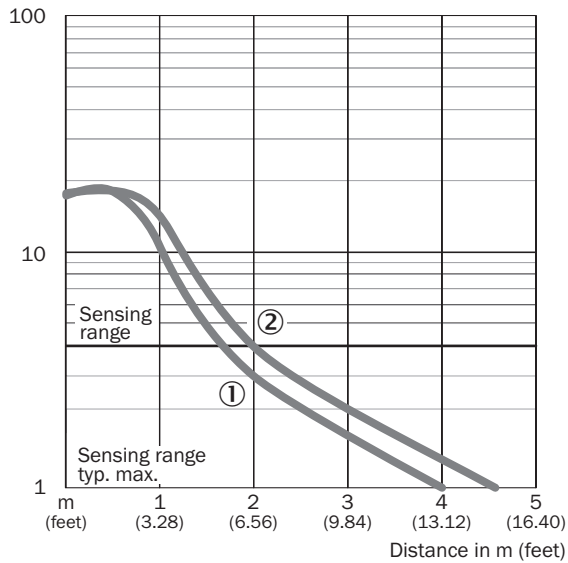

- ① Reflector PLV14-A / PLH25-M12 / PLH25-D12
- ② Reflector P41F / reflective tape REF-AC1000

### Light spot size Overview

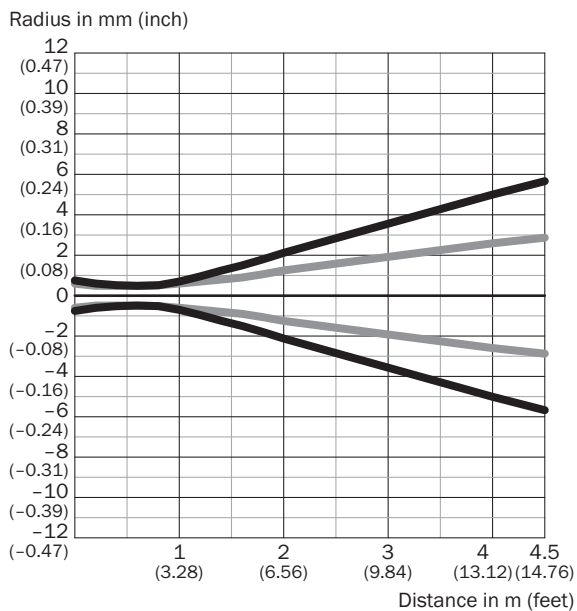

#### Dimensions in mm (inch)

Sensing range	Vertical	Horizontal
<b>0.5 m</b> <b>(1.64 feet)</b>	< 1.0 (0.04)	< 1.0 (0.04)
<b>1 m</b> <b>(3.28 feet)</b>	1.5 (0.06)	1.2 (0.05)
<b>2 m</b> <b>(6.56 feet)</b>	4.3 (0.17)	2.6 (0.10)
<b>4.5 m</b> <b>(14.76 feet)</b>	11.3 (0.44)	5.6 (0.22)

— Vertical  
— Horizontal

### Light spot size (detailed view)

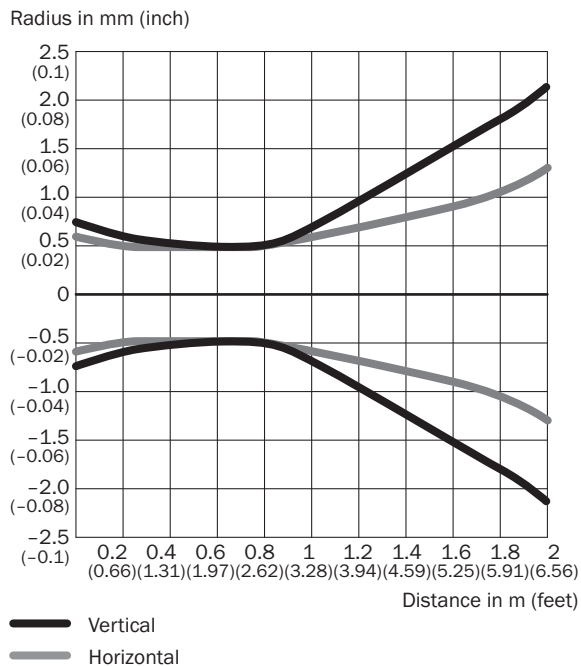

— Vertical  
— Horizontal

### Sensing range diagram

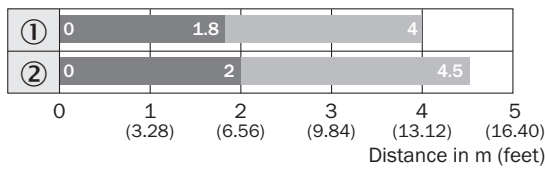

- Sensing range    ■ Sensing range max.
- ① Reflector PLV14-A / PLH25-M12 / PLH25-D12
  - ② Reflector P41F / reflective tape REF-AC1000



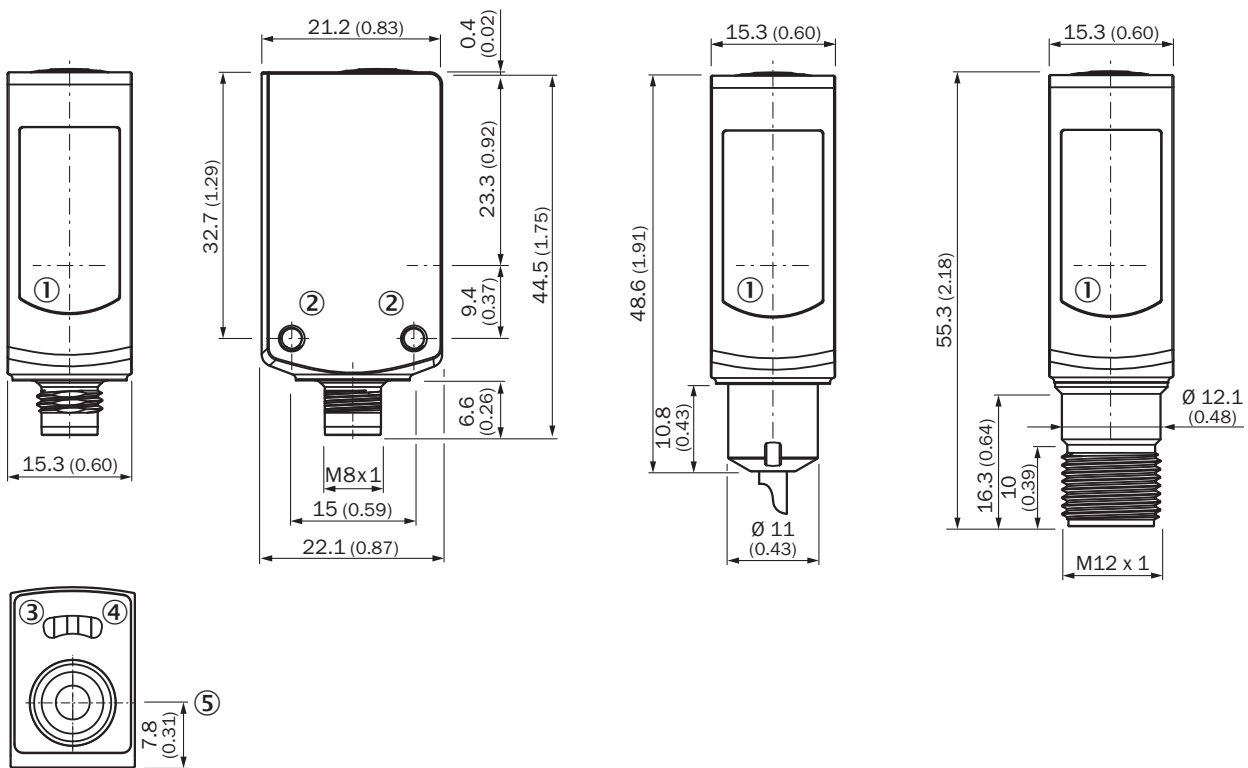

### Dimensional drawing WSE4SL-3, WL4SLG-3



- Dimensions in mm (inch)
- ① Center of optical axis
  - ② Threaded mounting hole M3
  - ③ LED indicator yellow: Status of received light beam
  - ④ LED indicator green: Supply voltage active
  - ⑤ single teach-in button

### Recommended accessories

Other models and accessories → [www.sick.com/W4](http://www.sick.com/W4)

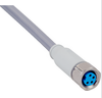
	Brief description	Type	part no.
<b>Mounting systems</b>			
	<ul style="list-style-type: none"> <li><b>Description:</b> Mounting bracket for floor mounting</li> <li><b>Material:</b> Stainless steel</li> <li><b>Details:</b> Stainless steel 1.4571</li> <li><b>Items supplied:</b> Mounting hardware included</li> <li><b>Suitable for:</b> W4S, W4F, W4S</li> </ul>	BEF-W4-B	2051630
	<ul style="list-style-type: none"> <li><b>Description:</b> Plate N02N for universal clamp bracket</li> <li><b>Material:</b> Stainless steel, stainless steel</li> <li><b>Details:</b> Stainless steel 1.4571 (sheet), Stainless steel 1.4408 (clamp)</li> <li><b>Items supplied:</b> Universal clamp (5322627), mounting hardware</li> <li><b>Usable for:</b> W4S-3 Glass, W10, W4SLG-3, W4S-3 Inox, W4S-3 Inox Glass, W9, W11-2, W12-3, W12-2 Laser, W12G, W12 Teflon, W16, W250, W250-2, PowerProx, W11G-2, TranspaTect, WTT12, UC12, P250, G6 Inox, W4S, W4SL-3V, W4SLG-3V, W4SL-3H</li> </ul>	BEF-KHS-N02N	2051618
<b>reflectors and optics</b>			
	<ul style="list-style-type: none"> <li><b>Description:</b> Stainless steel reflector, washdown design, chemically resistant, IP 69K enclosure rating, screw connection, PMMA front screens</li> <li><b>Dimensions:</b> 14 mm</li> <li><b>Ambient operating temperature:</b> -20 °C ... +60 °C</li> </ul>	PLV14-A	2063405
<b>connectors and cables</b>			
	<ul style="list-style-type: none"> <li><b>Description:</b> Sensor/actuator cable, unshielded</li> <li><b>Connection type head A:</b> Female connector, M8, 4-pin, straight</li> <li><b>Connection type head B:</b> Flying leads</li> <li><b>Signal type:</b> Sensor/actuator cable</li> <li><b>Cable:</b> 5 m, 4-wire, PP</li> <li><b>Connection systems:</b> Flying leads</li> <li><b>Note:</b> This product is generally resistant to chemical cleaning agents (see ECOLAB) and other chemical compounds such as H2O2 and CH2O2. Before permanent installation is carried out, the material's resistance to the cleaning agent being used must be checked., Resistant against lactic acid &amp; hydrogen peroxide (H2O2)</li> <li><b>Application:</b> Hygienic and washdown zones, Drag chain operation, Robot, cold bending resistant, seawater resistant</li> </ul>	DOL-0804-G05MRN	6058511
	<ul style="list-style-type: none"> <li><b>Description:</b> Sensor/actuator cable, unshielded</li> <li><b>Connection type head A:</b> Female connector, M8, 4-pin, straight</li> <li><b>Connection type head B:</b> Flying leads</li> <li><b>Signal type:</b> Sensor/actuator cable</li> <li><b>Cable:</b> 5 m, 4-wire, PVC</li> <li><b>Connection systems:</b> Flying leads</li> <li><b>Note:</b> This product is generally resistant to chemical cleaning agents (see ECOLAB). Please do not use cleaning agents of any other Kind., Not resistant against lactic acid &amp; hydrogen peroxide (H2O2)</li> <li><b>Application:</b> Uncontaminated zones, Hygienic and washdown zones, Zones with chemicals</li> </ul>	YF8U54-050VA3XLEAX	6059194

## SICK AT A GLANCE

SICK is one of the leading manufacturers of intelligent sensors and sensor solutions for industrial applications. A unique range of products and services creates the perfect basis for controlling processes securely and efficiently, protecting individuals from accidents and preventing damage to the environment.

We have extensive experience in a wide range of industries and understand their processes and requirements. With intelligent sensors, we can deliver exactly what our customers need. In application centers in Europe, Asia and North America, system solutions are tested and optimized in accordance with customer specifications. All this makes us a reliable supplier and development partner.

Comprehensive services complete our offering: SICK LifeTime Services provide support throughout the machine life cycle and ensure safety and productivity.

For us, that is “Sensor Intelligence.”

## WORLDWIDE PRESENCE:

Contacts and other locations –[www.sick.com](http://www.sick.com)