



# WSE4SL-3P2237

W4

PHOTOELECTRIC SENSORS

**SICK**  
Sensor Intelligence.



Illustration may differ



### Ordering information

| Type          | part no. |
|---------------|----------|
| WSE4SL-3P2237 | 1058249  |

Other models and accessories → [www.sick.com/W4](http://www.sick.com/W4)

### Detailed technical data

#### Features

|   |   |
|---|---|
| <b>Functional principle</b>                 | Through-beam photoelectric sensor                                 |
| <b>Sensing range max.</b>                   | 0 m ... 60 m  |
| <b>Sensing range</b>                        | 0 m ... 50 m  |
| <b>Emitted beam</b>                         |   |
| Light source                                | Laser <sup>1)</sup>   |
| Type of light                               | Visible red light   |
| Light spot size (distance)                  | Ø 1 mm (500 mm)   |
| <b>Key laser figures</b>                    |   |
| Normative reference                         | EN 60825-1:2014, IEC 60825-1:2014 / CDRH 21 CFR 1040.10 & 1040.11 |
| Laser class                                 | 1 <sup>2)</sup>   |
| Wave length                                 | 650 nm  |
| <b>Adjustment</b>                           | Single teach-in button  |
| <b>Special applications</b>                 | Detecting small objects   |
| <b>Part number of individual components</b> | 2064095 WS4SL-3D2236 2064097 WE4SL-3P2232                         |
| <b>Mounting hole</b>                        | M3  |

<sup>1)</sup> Average service life: 50,000 h at T<sub>U</sub> = +25 °C.

<sup>2)</sup> Do not intentionally look into the laser beam. Never point the laser beam at people's eyes.

#### Safety-related parameters

|                         |  |
|-------------------------|--|
| <b>MTTF<sub>D</sub></b> | 355 years (EN ISO 13849-1) <sup>1)</sup> |
| <b>DC<sub>avg</sub></b> | 0 %                                      |

<sup>1)</sup> Mode of calculation: Parts-Count-calculation.

## Electronics

|  |   |                                    |
|--|---|------------------------------------|
| <b>Supply voltage <math>U_B</math></b> | 10 V DC ... 30 V DC <sup>1)</sup>                     |                                    |
| <b>Ripple</b>                          | < 5 V <sub>pp</sub> <sup>2)</sup>                     |                                    |
| <b>Current consumption</b>             | 30 mA <sup>3)</sup>                                   |                                    |
| <b>Protection class</b>                | III   |                                    |
| <b>Digital output</b>                  | Type  | PNP <sup>4)</sup>                  |
|  | Switching mode  | Light/dark switching <sup>4)</sup> |
|  | Output current $I_{max.}$                             | ≤ 100 mA                           |
|  | Response time   | ≤ 0.5 ms <sup>5)</sup>             |
|  | Switching frequency                                   | 1,000 Hz <sup>6)</sup>             |
| <b>Output function</b>                 | Complementary   |                                    |
| <b>Circuit protection</b>              | A <sup>7)</sup><br>B <sup>8)</sup><br>C <sup>9)</sup> |                                    |

<sup>1)</sup> Limit values when operated in short-circuit protected network: max. 8 A.

<sup>2)</sup> May not fall below or exceed  $U_y$  tolerances.

<sup>3)</sup> Without load.

<sup>4)</sup> Q = light switching.

<sup>5)</sup> Signal transit time with resistive load.

<sup>6)</sup> With light/dark ratio 1:1.

<sup>7)</sup> A =  $V_S$  connections reverse-polarity protected.

<sup>8)</sup> B = inputs and output reverse-polarity protected.

<sup>9)</sup> C = interference suppression.

## Mechanics

|                               |                             |                  |
|-------------------------------|-----------------------------|------------------|
| <b>Housing</b>                | Rectangular                 |                  |
| <b>Design detail</b>          | Slim                        |                  |
| <b>Dimensions (W x H x D)</b> | 12.2 mm x 41.8 mm x 17.3 mm |                  |
| <b>Connection</b>             | Male connector M8, 4-pin    |                  |
| <b>Material</b>               | Housing                     | Plastic, Novodur |
|                               | Front screen                | Plastic, PMMA    |
| <b>Weight</b>                 | 100 g                       |                  |

## Ambient data

|   |                                    |
|---|------------------------------------|
| <b>Enclosure rating</b>                       | IP66<br>IP67                       |
| <b>Ambient operating temperature</b>          | -10 °C ... +50 °C                  |
| <b>Ambient operating temperature extended</b> | -30 °C ... +55 °C <sup>1) 2)</sup> |
| <b>Ambient temperature, storage</b>           | -30 °C ... +70 °C                  |

<sup>1)</sup> As of  $T_a = 50$  °C, a max. supply voltage  $V_{max.} = 24$  V and a max. load current  $I_{max.} = 50$  mA is permitted.

<sup>2)</sup> Operation below  $T_u -10$  °C is possible if the sensor is already switched on at  $T_u > -10$  °C, then cools down, and the supply voltage is subsequently not switched off. Switching on below  $T_u -10$  °C is not permissible.

### Certificates

|   |   |
|---|---|
| <b>EU declaration of conformity</b>           | ✓ |
| <b>UK declaration of conformity</b>           | ✓ |
| <b>ACMA declaration of conformity</b>         | ✓ |
| <b>Moroccan declaration of conformity</b>     | ✓ |
| <b>China RoHS</b>                             | ✓ |
| <b>ECOLAB certificate</b>                     | ✓ |
| <b>Laser safety (IEC 60825-1) certificate</b> | ✓ |

### Classifications

|                       |          |
|-----------------------|----------|
| <b>ECLASS 5.0</b>     | 27270901 |
| <b>ECLASS 5.1.4</b>   | 27270901 |
| <b>ECLASS 6.0</b>     | 27270901 |
| <b>ECLASS 6.2</b>     | 27270901 |
| <b>ECLASS 7.0</b>     | 27270901 |
| <b>ECLASS 8.0</b>     | 27270901 |
| <b>ECLASS 8.1</b>     | 27270901 |
| <b>ECLASS 9.0</b>     | 27270901 |
| <b>ECLASS 10.0</b>    | 27270901 |
| <b>ECLASS 11.0</b>    | 27270901 |
| <b>ECLASS 12.0</b>    | 27270901 |
| <b>ETIM 5.0</b>       | EC002716 |
| <b>ETIM 6.0</b>       | EC002716 |
| <b>ETIM 7.0</b>       | EC002716 |
| <b>ETIM 8.0</b>       | EC002716 |
| <b>UNSPSC 16.0901</b> | 39121528 |

### Connection diagram Cd-232

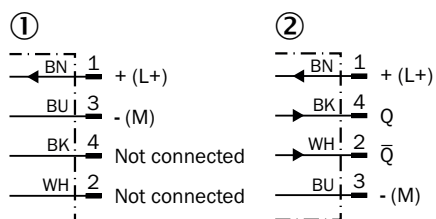

- ① sender
- ② receiver

### Characteristic curve

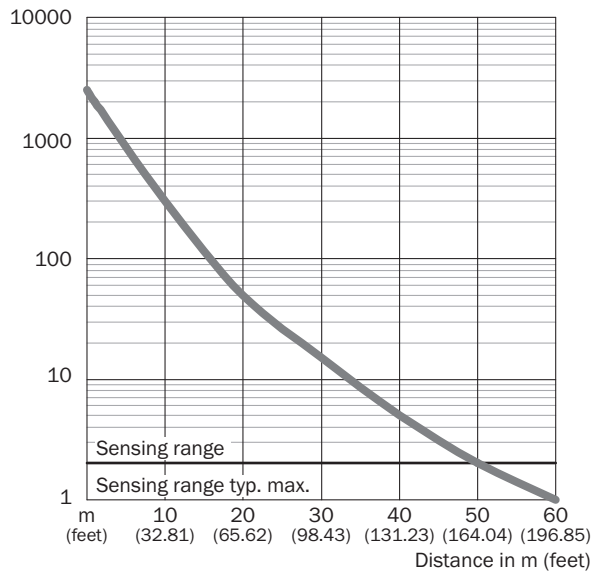

### Light spot size

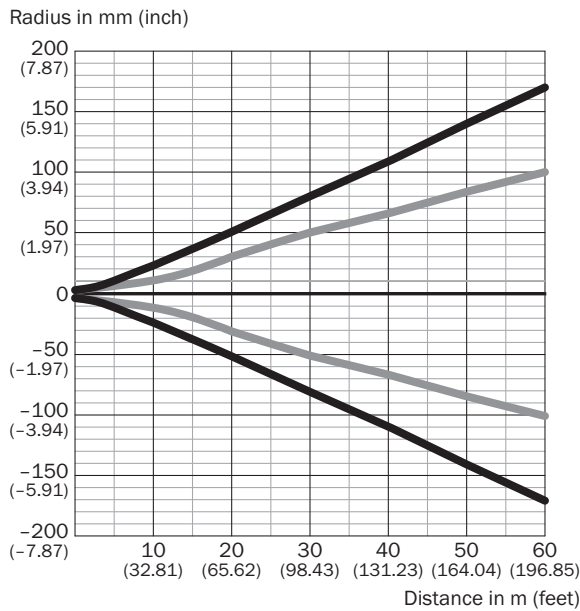

#### Dimensions in mm (inch)

| Sensing range                       | Vertical        | Horizontal      |
|-------------------------------------|-----------------|-----------------|
| <b>0.5 m</b><br><b>(1.64 feet)</b>  | < 1.0<br>(0.04) | < 1.0<br>(0.04) |
| <b>1 m</b><br><b>(3.28 feet)</b>    | 1.5<br>(0.06)   | 1.2<br>(0.05)   |
| <b>5 m</b><br><b>(16.40 feet)</b>   | 15<br>(0.59)    | 11<br>(0.43)    |
| <b>10 m</b><br><b>(32.81 feet)</b>  | 45<br>(1.77)    | 28<br>(1.10)    |
| <b>60 m</b><br><b>(196.85 feet)</b> | 336<br>(13.23)  | 200<br>(7.87)   |

— Vertical  
 — Horizontal

Light spot size (detailed view) Detailed view close range

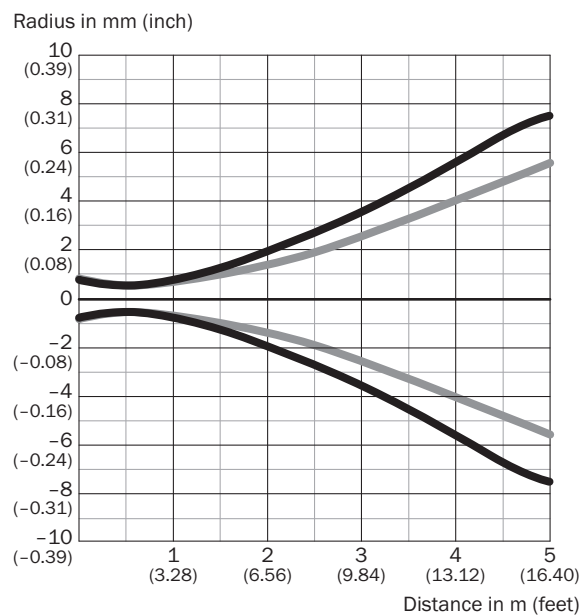

— Vertical  
 — Horizontal

Sensing range diagram

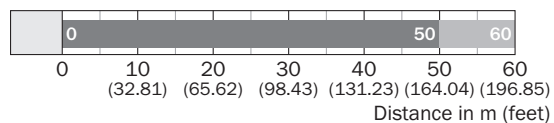

■ Sensing range      ■ Sensing range typ. max.

Dimensional drawing WL4SL-3, WL4SLG-3, WSE4SL-3, plug

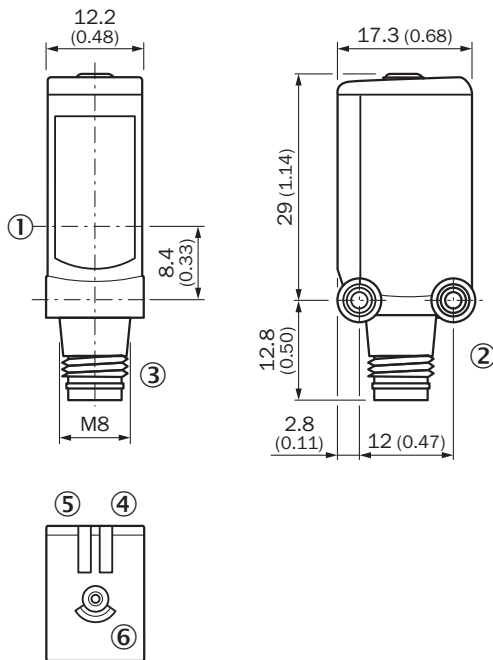



Dimensions in mm (inch)

- ① Center of optical axis
- ② Threaded mounting hole M3
- ③ Connection
- ④ LED indicator green: Supply voltage active
- ⑤ LED indicator yellow: Status of received light beam
- ⑥ single teach-in button

Recommended accessories

Other models and accessories → [www.sick.com/W4](http://www.sick.com/W4)

|   | Brief description   | Type               | part no. |
|---|---|--------------------|----------|
| connectors and cables   |   |                    |          |
|  | <ul style="list-style-type: none"> <li><b>Description:</b> Sensor/actuator cable, unshielded</li> <li><b>Connection type head A:</b> Female connector, M8, 4-pin, straight, A-coded</li> <li><b>Connection type head B:</b> Flying leads</li> <li><b>Signal type:</b> Sensor/actuator cable</li> <li><b>Cable:</b> 5 m, 4-wire, PVC</li> <li><b>Application:</b> Uncontaminated zones, Zones with chemicals</li> </ul>  | YF8U14-050VA3XLEAX | 2095889  |
|  | <ul style="list-style-type: none"> <li><b>Description:</b> Unshielded</li> <li><b>Connection type head A:</b> Male connector, M8, 4-pin, straight, A-coded</li> <li><b>Connection systems:</b> Screw-type terminals</li> <li><b>Permitted cross-section:</b> 0.14 mm<sup>2</sup> ... 0.5 mm<sup>2</sup></li> </ul>  | STE-0804-G         | 6037323  |
|  | <ul style="list-style-type: none"> <li><b>Description:</b> Sensor/actuator cable, unshielded</li> <li><b>Connection type head A:</b> Female connector, M8, 4-pin, straight, A-coded</li> <li><b>Connection type head B:</b> Flying leads</li> <li><b>Signal type:</b> Sensor/actuator cable</li> <li><b>Cable:</b> 5 m, 4-wire, PUR, halogen-free</li> <li><b>Application:</b> Drag chain operation, Zones with oils and lubricants, Robot, Drag chain operation</li> </ul> | YF8U14-050UA3XLEAX | 2094792  |

## SICK AT A GLANCE

SICK is one of the leading manufacturers of intelligent sensors and sensor solutions for industrial applications. A unique range of products and services creates the perfect basis for controlling processes securely and efficiently, protecting individuals from accidents and preventing damage to the environment.

We have extensive experience in a wide range of industries and understand their processes and requirements. With intelligent sensors, we can deliver exactly what our customers need. In application centers in Europe, Asia and North America, system solutions are tested and optimized in accordance with customer specifications. All this makes us a reliable supplier and development partner.

Comprehensive services complete our offering: SICK LifeTime Services provide support throughout the machine life cycle and ensure safety and productivity.

For us, that is “Sensor Intelligence.”

## WORLDWIDE PRESENCE:

Contacts and other locations –[www.sick.com](http://www.sick.com)