



GRTE18S-N1342

GR18

PHOTOELECTRIC SENSORS

SICK
Sensor Intelligence.



Illustration may differ

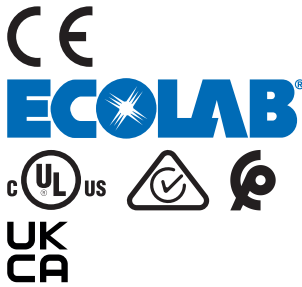

Ordering information

| Type | part no. |
|---------------|----------|
| GRTE18S-N1342 | 1058202 |

Other models and accessories → www.sick.com/GR18

Detailed technical data

Features

| | |
|--|--|
| Functional principle | Photoelectric proximity sensor |
| Functional principle detail | Energetic |
| Dimensions (W x H x D) | 18 mm x 18 mm x 38.1 mm |
| Housing design (light emission) | Cylindrical |
| Thread diameter (housing) | M18 x 1 |
| Optical axis | Axial |
| Sensing range max. | 5 mm ... 550 mm ¹⁾ |
| Sensing range | 10 mm ... 400 mm ¹⁾ |
| Type of light | Visible red light |
| Light source | PinPoint LED ²⁾ |
| Light spot size (distance) | Ø 9 mm (400 mm) |
| Wave length | 650 nm |
| Adjustment | Potentiometer, 270° |
| Display | |
| | LED green |
| | Operating indicator Static on: power on |
| | LED yellow |
| | Status of received light beam Static on: object present Static off: object not present |

¹⁾ Object with 90% remission (based on standard white, DIN 5033).

²⁾ Average service life: 100,000 h at T_U = +25 °C.

Mechanics/electronics

| | |
|--|---|
| Supply voltage U_B | 10 V DC ... 30 V DC ¹⁾ |
| Ripple | < 5 V _{pp} ²⁾ |
| Current consumption | 30 mA |
| Switching output | NPN |
| Switching mode | Light switching |
| Signal voltage NPN HIGH/LOW | Approx. $V_S / \leq 3$ V |
| Output current I_{max} | ≤ 100 mA ³⁾ |
| Response time | < 1,000 μ s ⁴⁾ |
| Switching frequency | 500 Hz ⁵⁾ |
| Connection type | Cable, 3-wire, 2 m ⁶⁾ |
| Cable material | Plastic, PVC |
| Circuit protection | A ⁷⁾ B ⁸⁾ D ⁹⁾ |
| Protection class | III |
| Housing material | Metal, Nickel-plated brass and ABS |
| Optics material | Plastic, PMMA |
| Enclosure rating | IP67 |
| Items supplied | Fastening nuts (2 x) |
| Electromagnetic compatibility (EMC) | EN 60947-5-2 |
| Ambient operating temperature | -25 °C ... +55 °C ¹⁰⁾ |
| Ambient temperature, storage | -40 °C ... +70 °C |
| UL File No. | NRKH.E348498 & NRKH7.E348498 |

¹⁾ Limit values. Operated in short-circuit protected network: max. 8 A.

²⁾ May not fall below or exceed U_V tolerances.

³⁾ At $U_V > 24$ V or ambient temperature > 49 °C, I_A max. = 50 mA.

⁴⁾ Signal transit time with resistive load.

⁵⁾ With light/dark ratio 1:1.

⁶⁾ Do not bend below 0 °C.

⁷⁾ A = V_S connections reverse-polarity protected.

⁸⁾ B = inputs and output reverse-polarity protected.

⁹⁾ D = outputs overcurrent and short-circuit protected.

¹⁰⁾ At $U_V \leq 24$ V and $I_A < 50$ mA.

Safety-related parameters

| | |
|-------------------------|-------------|
| MTTF_D | 1,917 years |
| DC_{avg} | 0 % |

Certificates

| | |
|---|---|
| EU declaration of conformity | ✓ |
| UK declaration of conformity | ✓ |
| ACMA declaration of conformity | ✓ |
| Moroccan declaration of conformity | ✓ |
| China RoHS | ✓ |

| | |
|--|---|
| ECOLAB certificate | ✓ |
| cULus certificate | ✓ |
| Photobiological safety (DIN EN 62471) certificate | ✓ |

Classifications

| | |
|-----------------------|----------|
| ECLASS 5.0 | 27270903 |
| ECLASS 5.1.4 | 27270903 |
| ECLASS 6.0 | 27270903 |
| ECLASS 6.2 | 27270903 |
| ECLASS 7.0 | 27270903 |
| ECLASS 8.0 | 27270903 |
| ECLASS 8.1 | 27270903 |
| ECLASS 9.0 | 27270903 |
| ECLASS 10.0 | 27270904 |
| ECLASS 11.0 | 27270904 |
| ECLASS 12.0 | 27270903 |
| ETIM 5.0 | EC001821 |
| ETIM 6.0 | EC001821 |
| ETIM 7.0 | EC002719 |
| ETIM 8.0 | EC002719 |
| UNSPSC 16.0901 | 39121528 |

Adjustments GRTB18(S), GRTE18(S), Sensing range setting: Potentiometer, 270°

Sensing range

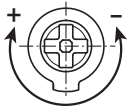

Connection type

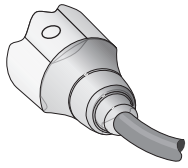

Connection diagram Cd-044

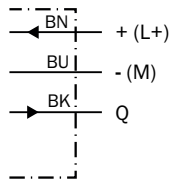

Characteristic curve GRTE18S, 400 mm

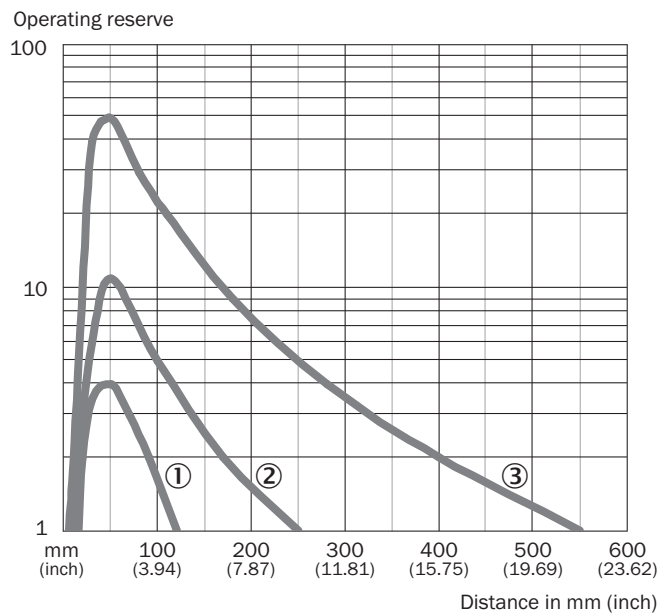

- ① Sensing range on black, 6% remission factor
- ② sensing range to gray, 20% remission factor
- ③ Sensing range on white, 90% remission factor

Light spot size GRTE18S, 400 mm

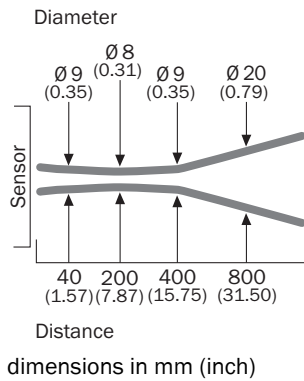

Sensing range diagram GRTE18S, 400 mm

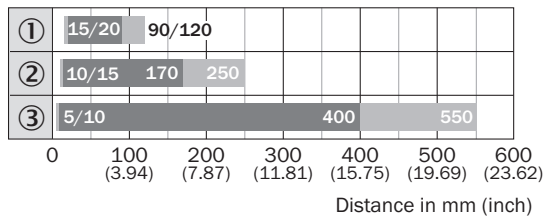

- Sensing range ■ Sensing range max.
- ① Sensing range on black, 6% remission factor
- ② sensing range to gray, 20% remission factor
- ③ Sensing range on white, 90% remission factor

Response range GRTE18S, 400 mm

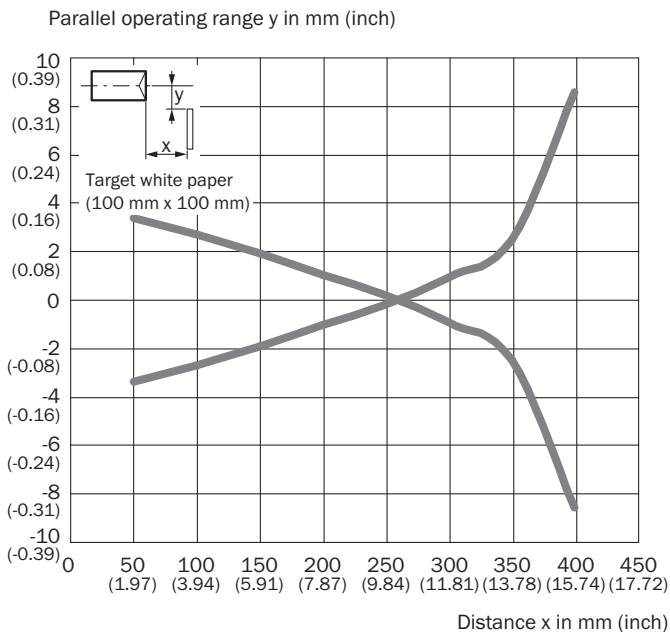

Dimensional drawing GR18S, metal, cable, straight, adjustable

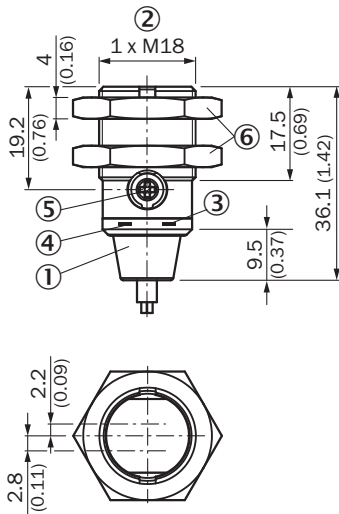



Dimensions in mm (inch)

- ① Connection cable 2 m
- ② Threaded mounting hole M18 x 1
- ③ LED indicator yellow
- ④ LED indicator green
- ⑤ sensitivity control: potentiometer 270°
- ⑥ Fastening nuts (2x); width across 24, metal

Recommended accessories

Other models and accessories → www.sick.com/GR18

| | Brief description | Type | part no. |
|---|---|------------|----------|
| Mounting systems | | | |
|  | <ul style="list-style-type: none"> • Description: Mounting bracket for M18 sensors • Material: Steel • Details: Steel, zinc coated • Items supplied: Without mounting hardware • Suitable for: GR18, V180-2, V18, W15, Z1, Z2 | BEF-WN-M18 | 5308446 |
| connectors and cables | | | |
|  | <ul style="list-style-type: none"> • Connection type head A: Male connector, M8, 3-pin, straight, A-coded • Description: Unshielded • Connection systems: Screw-type terminals • Permitted cross-section: 0.14 mm² ... 0.5 mm² | STE-0803-G | 6037322 |

SICK AT A GLANCE

SICK is one of the leading manufacturers of intelligent sensors and sensor solutions for industrial applications. A unique range of products and services creates the perfect basis for controlling processes securely and efficiently, protecting individuals from accidents and preventing damage to the environment.

We have extensive experience in a wide range of industries and understand their processes and requirements. With intelligent sensors, we can deliver exactly what our customers need. In application centers in Europe, Asia and North America, system solutions are tested and optimized in accordance with customer specifications. All this makes us a reliable supplier and development partner.

Comprehensive services complete our offering: SICK LifeTime Services provide support throughout the machine life cycle and ensure safety and productivity.

For us, that is “Sensor Intelligence.”

WORLDWIDE PRESENCE:

Contacts and other locations –www.sick.com