



DL100-23HA2112

Dx100

TIME-OF-FLIGHT SENSORS

SICK
Sensor Intelligence.



Illustration may differ



Ordering information

Type	part no.
DL100-23HA2112	1058169

Other models and accessories → www.sick.com/Dx100

Detailed technical data

Features

Measuring range	0.15 m ... 300 m, on "diamond grade" reflective tape
Scope	Indoor
Target	Reflector
Resolution	0.1 mm, 0.125 mm, 1 mm, 10 mm, 100 mm, freely adjustable
Repeatability	2 mm ¹⁾
Measurement accuracy	± 3 mm ²⁾
Response time	2 ms
Measurement cycle time	1 ms
Output time	1 ms
Emitted beam	
Light source	Laser, red ³⁾
Type of light	Visible red light
Typ. light spot size (distance)	5 mm + (2 mm x distance in m)
Key laser figures	
Normative reference	IEC 60825-1:2014, EN 60825-1:2014
Laser class	2 ⁴⁾
Max. movement speed	15 m/s
Acceleration (max.)	≤ 15 m/s ²
Heating	✓
Safety-related parameters	

¹⁾ Statistical error 1 σ, environmental conditions constant, min. warm-up time 10 min.

²⁾ From 150 mm ... 180 mm measuring range the accuracy can reach ± 4 mm.

³⁾ Average service life: 100,000 h at T_J = +25 °C.

⁴⁾ Do not intentionally look into the laser beam. Never point the laser beam at people's eyes.

MTTF _D	101 years
DC _{avg}	0%

1) Statistical error 1 σ , environmental conditions constant, min. warm-up time 10 min.

2) From 150 mm ... 180 mm measuring range the accuracy can reach ± 4 mm.

3) Average service life: 100,000 h at T_U = +25 °C.

4) Do not intentionally look into the laser beam. Never point the laser beam at people's eyes.

Interfaces

PROFINET	✓
Digital output	
Number	2 ¹⁾
Type	Push-pull: PNP/NPN
Function	Distance: Distance switching output Speed: Speed output Service: Warning message as the sensor ages, if the damping value is exceeded (for example when contaminated, if the permitted interior device temperature is exceeded or undercut, if the measured value has a plausibility error, if the laser is not ready for operation, if the heating is switched on Laser off Preset
Maximum output current I _A	≤ 100 mA ²⁾
Multifunctional input (MF)	1 x MF1 ³⁾

1) HIGH = > V_S - 3 V / LOW = < 2 V.

2) Max. 100 nF/20 mH.

3) HIGH > 12 V / LOW < 3 V.

Electronics

Supply voltage U_B	DC 18 V ... 30 V, limit values
Current consumption	At 24 V DC < 1,000 mA
Ripple	5 V _{pp} ¹⁾
Modulation frequency	Fix
Initialization time	Typ. 1.5 s ²⁾
Display	6 digit 5 x 7 dot matrix display, LEDs
Enclosure rating	IP65
Protection class	III
Connection type	Male connector

1) May not fall short of or exceed V_S tolerances.

2) After loss of reflector < 40 ms.

Mechanics

Dimensions (W x H x D)	69.4 mm x 82.5 mm x 100.2 mm
Housing material	Metal (Aluminum die cast)
Window material	Plastic (PMMA)
Weight	Approx. 800 g (with mounting bracket: approx. 1,600 g)

Ambient data

Ambient temperature, operation	-40 °C ... +55 °C, operation with heating ^{1) 2)} -40 °C ... +75 °C, operation with cooling case ^{1) 2)}
Ambient temperature, storage	-40 °C ... +75 °C
Effect of air pressure	0.3 ppm/hPa
Effect of air temperature	1 ppm/K
Temperature drift	Typ. 0.1 mm/K
Typ. Ambient light immunity	≤ 100,000 lx
Mechanical load	Shock: (EN 600 68-2-27) Sine: (EN 600 68-2-6) Noise: (EN 600 68-2-64)
Electromagnetic compatibility (EMC)	EN 61000-6-2, EN 61000-6-4 ³⁾

¹⁾ Temperatures < -10 °C require warm-up time of typ. 7 minutes.

²⁾ For operation below -20 °C, a supply voltage of at least 24 V is required.

³⁾ This is a Class A device. This device can cause radio interference in living quarters.

Certificates

EU declaration of conformity	✓
UK declaration of conformity	✓
ACMA declaration of conformity	✓
Moroccan declaration of conformity	✓
China RoHS	✓
cULus certificate	✓
Profinet certificate	✓
Information according to Art. 3 of Data Act (Regulation EU 2023/2854)	✓

Classifications

ECLASS 5.0	27270801
ECLASS 5.1.4	27270801
ECLASS 6.0	27270801
ECLASS 6.2	27270801
ECLASS 7.0	27270801
ECLASS 8.0	27270801
ECLASS 8.1	27270801
ECLASS 9.0	27270801
ECLASS 10.0	27270801
ECLASS 11.0	27270801
ECLASS 12.0	27270916
ETIM 5.0	EC001825
ETIM 6.0	EC001825
ETIM 7.0	EC001825
ETIM 8.0	EC001825
UNSPSC 16.0901	41111613

Dimensional drawing

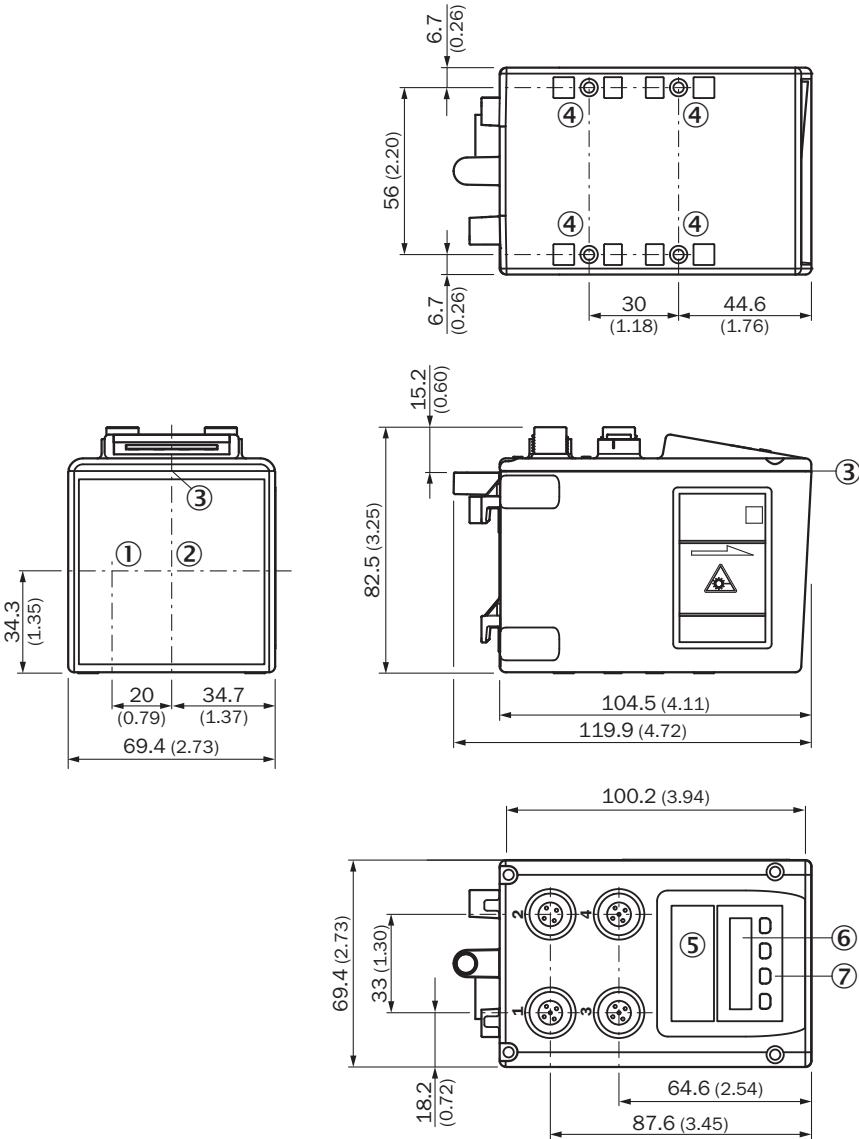

- Dimensions in mm (inch)
- ① Optical axis, sender
 - ② Optical axis, receiver
 - ③ Zero level
 - ④ Threaded mounting hole M5
 - ⑤ status LED [status]
 - ⑥ Display
 - ⑦ Control elements

Ethernet connection type

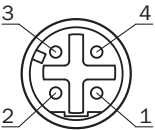

Voltage supply connection type



PROFINET port 1, port 2 connection type

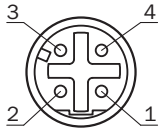

Voltage supply connection diagram



Ethernet connection diagram

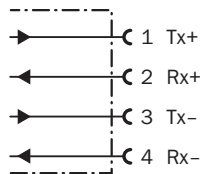



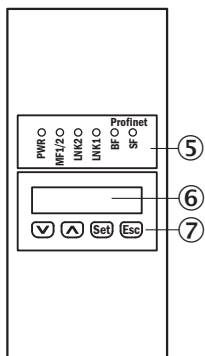

Adjustment possible DL100-xxxxxx12



- ⑤ status LED [status]
- ⑥ Display
- ⑦ Control elements

Recommended accessories

Other models and accessories → www.sick.com/Dx100

	Brief description	Type	part no.
reflectors and optics			
	<ul style="list-style-type: none"> Description: Reflector plate, "diamond grade" reflective tape, 665 mm x 665 mm, base plate material: aluminum, screw connection Ambient operating temperature: -25 °C ... +65 °C 	PL560DG	1016806
	<ul style="list-style-type: none"> Description: Reflector plate, "diamond grade" reflective tape, 330 mm x 330 mm, base plate material: aluminum, screw connection Ambient operating temperature: -34 °C ... +70 °C 	PL240DG	1017910
Mounting systems			
	<ul style="list-style-type: none"> Description: Alignment unit for Dx100, incl. mounting material Material: Steel Details: Steel, zinc coated 	BEF-AH-DX100	2058653
connectors and cables			
	<ul style="list-style-type: none"> Description: Sensor/actuator cable, unshielded Connection type head A: Female connector, M12, 4-pin, straight, A-coded Connection type head B: Flying leads Signal type: Sensor/actuator cable Cable: 5 m, 4-wire, PVC Application: Uncontaminated zones, Zones with chemicals 	YF2A14-050VB3XLEAX	2096235
	<ul style="list-style-type: none"> Connection type head A: Male connector, M12, 4-pin, straight, D-coded Connection type head B: Flying leads Signal type: Ethernet, PROFINET Cable: 5 m, 4-wire, PUR, halogen-free Description: Ethernet, shielded, PROFINET Application: Drag chain operation, Zones with oils and lubricants 	YM2D24-050P-N1XLEAX	2106172

SICK AT A GLANCE

SICK is one of the leading manufacturers of intelligent sensors and sensor solutions for industrial applications. A unique range of products and services creates the perfect basis for controlling processes securely and efficiently, protecting individuals from accidents and preventing damage to the environment.

We have extensive experience in a wide range of industries and understand their processes and requirements. With intelligent sensors, we can deliver exactly what our customers need. In application centers in Europe, Asia and North America, system solutions are tested and optimized in accordance with customer specifications. All this makes us a reliable supplier and development partner.

Comprehensive services complete our offering: SICK LifeTime Services provide support throughout the machine life cycle and ensure safety and productivity.

For us, that is “Sensor Intelligence.”

WORLDWIDE PRESENCE:

Contacts and other locations –www.sick.com