





### Ordering information

Type	part no.
DS35-B15821	1057656

Other models and accessories → [www.sick.com/Dx35](http://www.sick.com/Dx35)



### Detailed technical data

#### Features

<b>Measuring range</b>	50 mm ... 12,000 mm, 90% remission factor <sup>1) 2)</sup> 50 mm ... 5,300 mm, 18% reflection factor 50 mm ... 3,100 mm, 6% remission factor
<b>Target</b>	Natural objects
<b>Resolution</b>	100 µm
<b>Repeatability</b>	≥ 0.5 mm <sup>2) 3)</sup>
<b>Measurement accuracy</b>	Typ. ± 10 mm <sup>4)</sup>
<b>Response time</b>	2.5 ms ... 96.5 ms, 2.5 ms / 6.5 ms / 12.5 ms / 24.5 ms / 96.5 ms <sup>5) 6)</sup>
<b>Switching frequency</b>	333 Hz / 100 Hz / 50 Hz / 25 Hz / 6 Hz <sup>5) 6)</sup>
<b>Output time</b>	1 ms ... 32 ms, 1 ms/2 ms/4 ms/8 ms/32 ms <sup>5) 7)</sup>
<b>Emitted beam</b>	
Light source	Laser, infrared <sup>8)</sup>
Type of light	Infrared light
Typ. light spot size (distance)	15 mm x 15 mm (at 2 m)
<b>Key laser figures</b>	
Normative reference	IEC 60825-1:2014, EN 60825-1:2014
Laser class	1 <sup>9)</sup>

<sup>1)</sup> For speed setting Slow.

<sup>2)</sup> See repeatability characteristic lines.

<sup>3)</sup> Equivalent to 1 σ.

<sup>4)</sup> 6% ... 90% remission factor.

<sup>5)</sup> Depending on the set speed: Super Fast ... Super Slow.

<sup>6)</sup> Lateral entry of the object into the measuring range.

<sup>7)</sup> Continuous change of distance in measuring range.

<sup>8)</sup> Wavelength: 827 nm; max. output: 130 mW; pulse duration: 3.5 ns; duty cycle: 1/250.

<sup>9)</sup> Do not intentionally look into the laser beam. Never point the laser beam at people's eyes.

Average laser service life (at 25 °C)	100,000 h	
<b>Additional function</b>	Set speed: Super Fast ... Super Slow Switching mode: Distance to Object (DtO) / switching window / object between sensor and background (ObSB) Teach-in of digital output and digital output invertible Multifunctional input: laser off / external teach / deactivated Reset to factory default	
<b>Safety-related parameters</b>	MTTF <sub>D</sub>	101 years
	DC <sub>avg</sub>	0%

- 1) For speed setting Slow.
- 2) See repeatability characteristic lines.
- 3) Equivalent to 1  $\sigma$ .
- 4) 6% ... 90% remission factor.
- 5) Depending on the set speed: Super Fast ... Super Slow.
- 6) Lateral entry of the object into the measuring range.
- 7) Continuous change of distance in measuring range.
- 8) Wavelength: 827 nm; max. output: 130 mW; pulse duration: 3.5 ns; duty cycle: 1/250.
- 9) Do not intentionally look into the laser beam. Never point the laser beam at people's eyes.

## Interfaces

<b>IO-Link</b>	✓ , IO-Link V1.1
Function	Process data, parameterization, diagnosis
Data transmission rate	38.4 kbit/s
<b>Digital output</b>	
Number	2 <sup>1) 2)</sup>
Type	Push-pull: PNP/NPN
Function	Output Q <sub>2</sub> , adaptable: digital output/Q <sub>1</sub> not/deactivated
Maximum output current I <sub>A</sub>	≤ 100 mA
<b>Multifunctional input (MF)</b>	1 x <sup>3)</sup>
<b>Hysteresis</b>	0 mm ... 11,950 mm <sup>4)</sup>

- 1) Output Q short-circuit protected.
- 2) Voltage drop < 3 V.
- 3) Response time ≤ 60 ms.
- 4) Configurable via IO-Link.

## Electronics

<b>Supply voltage U<sub>B</sub></b>	DC 12 V ... 30 V <sup>1) 2)</sup>
<b>Power consumption</b>	≤ 1.7 W <sup>3)</sup>
<b>Ripple</b>	≤ 5 V <sub>pp</sub> <sup>4)</sup>
<b>Initialization time</b>	≤ 500 ms
<b>Warm-up time</b>	≤ 20 min
<b>Display</b>	LEDs
<b>Enclosure rating</b>	IP65

- 1) Limit values, reverse-polarity protected, operation in short-circuit protected network: max. 8 A.
- 2) When using IO-Link output V<sub>S</sub> > 18 V.
- 3) Without load, at +20 °C.
- 4) May not fall short of or exceed V<sub>S</sub> tolerances.

	IP67
<b>Protection class</b>	III
<b>Connection type</b>	Male connector

<sup>1)</sup> Limit values, reverse-polarity protected, operation in short-circuit protected network: max. 8 A.

<sup>2)</sup> When using IO-Link output  $V_S > 18$  V.

<sup>3)</sup> Without load, at +20 °C.

<sup>4)</sup> May not fall short of or exceed  $V_S$  tolerances.

### Mechanics

<b>Dimensions (W x H x D)</b>	32 mm x 58.67 mm x 42.7 mm
<b>Housing material</b>	Plastic (ABS/PC)
<b>Window material</b>	Plastic (PMMA)
<b>Weight</b>	65 g

### Ambient data

<b>Ambient temperature, operation</b>	-30 °C ... +55 °C, $U_V \leq 24$ V
<b>Ambient temperature, storage</b>	-40 °C ... +75 °C
<b>Max. rel. humidity (not condensing)</b>	$\leq 95$ %
<b>Vibration resistance</b>	EN 60068-2-6, EN 60068-2-64
<b>Shock resistance</b>	EN 60068-2-27
<b>Electromagnetic compatibility (EMC)</b>	EN 61000-6-2, EN 61000-6-3, EN 61000-6-4 <sup>1)</sup>

<sup>1)</sup> This is a Class A device. This device can cause radio interference in living quarters.

### Certificates

<b>EU declaration of conformity</b>	✓
<b>UK declaration of conformity</b>	✓
<b>ACMA declaration of conformity</b>	✓
<b>Moroccan declaration of conformity</b>	✓
<b>China RoHS</b>	✓
<b>cULus certificate</b>	✓
<b>cTUVus certificate</b>	✓
<b>Information according to Art. 3 of Data Act (Regulation EU 2023/2854)</b>	✓

### Classifications

<b>ECLASS 5.0</b>	27270801
<b>ECLASS 5.1.4</b>	27270801
<b>ECLASS 6.0</b>	27270801
<b>ECLASS 6.2</b>	27270801
<b>ECLASS 7.0</b>	27270801
<b>ECLASS 8.0</b>	27270801
<b>ECLASS 8.1</b>	27270801
<b>ECLASS 9.0</b>	27270801
<b>ECLASS 10.0</b>	27270801

<b>ECLASS 11.0</b>	27270801
<b>ECLASS 12.0</b>	27270916
<b>ETIM 5.0</b>	EC001825
<b>ETIM 6.0</b>	EC001825
<b>ETIM 7.0</b>	EC001825
<b>ETIM 8.0</b>	EC001825
<b>UNSPSC 16.0901</b>	41111613

Dimensional drawing

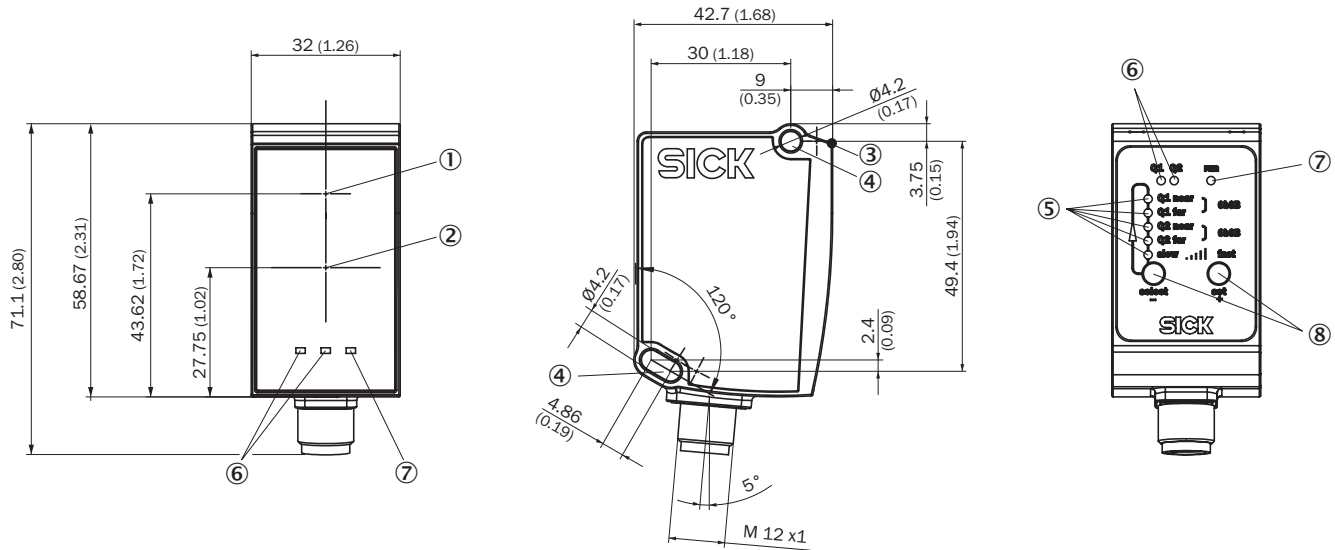

Dimensions in mm (inch)

- ① Optical axis, sender
- ② Optical axis, receiver
- ③ Zero level
- ④ Mounting hole M4
- ⑤ status indicator output Qa/Q2
- ⑥ Status LEDs output Q<sub>1</sub>
- ⑦ Operating indicator
- ⑧ Control elements

Connection type Plug, M12, 5-pin

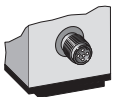

Connection diagram

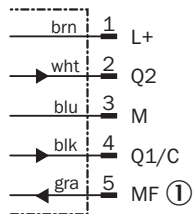

① Multifunctional input (MF)

characteristic curve 3) Medium

**Medium**

Repeatability in mm (inch)

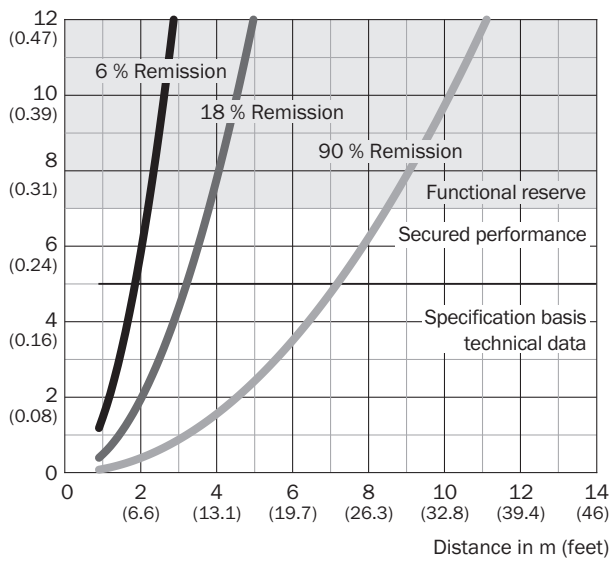

characteristic curve 5) Super Fast

**Super Fast**

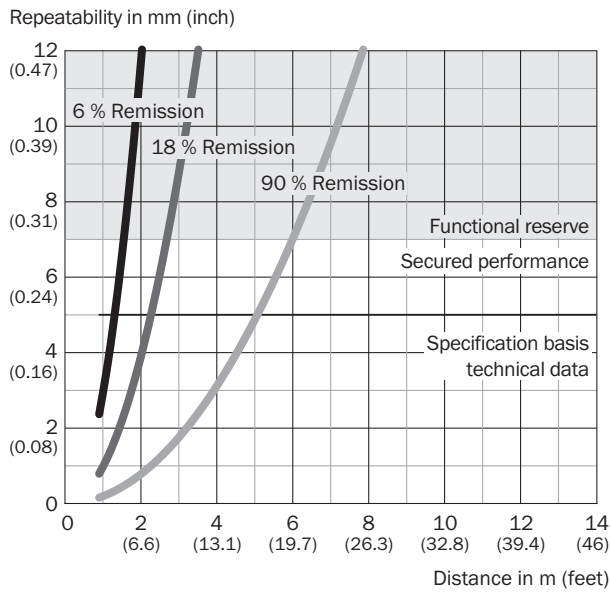

characteristic curve 4) Fast

**Fast**

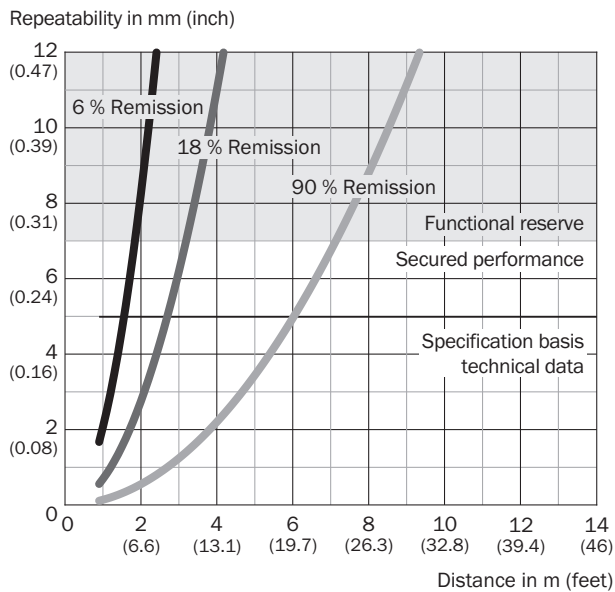

characteristic curve 2) Slow

**Slow**

Repeatability in mm (inch)

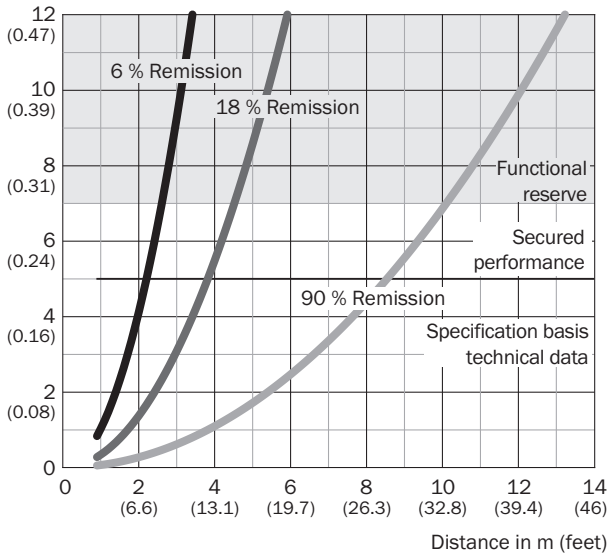

characteristic curve 1) Super Slow

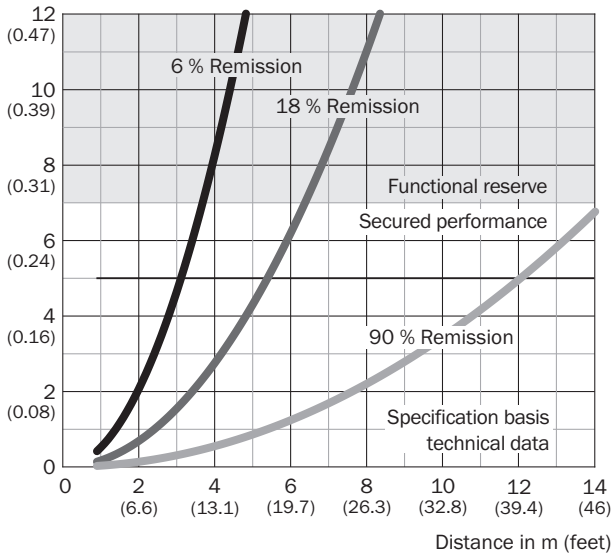

**Super Slow**

Repeatability in mm (inch)



## Recommended accessories

Other models and accessories → [www.sick.com/Dx35](http://www.sick.com/Dx35)

	Brief description	Type	part no.
Mounting systems			
	<ul style="list-style-type: none"> <li><b>Description:</b> Alignment unit</li> <li><b>Material:</b> Steel</li> <li><b>Details:</b> Steel, zinc coated</li> <li><b>Items supplied:</b> Mounting hardware for the sensor included</li> </ul>	BEF-AH-DX50	2048397
	<ul style="list-style-type: none"> <li><b>Description:</b> Plate N02 for universal clamp bracket</li> <li><b>Material:</b> Steel, zinc diecast</li> <li><b>Details:</b> Zinc plated steel (sheet), Zinc die cast (clamping bracket)</li> <li><b>Items supplied:</b> Universal clamp (5322626), mounting hardware</li> <li><b>Usable for:</b> W4S-3 Glass, W10, W4SLG-3, W4S-3 Inox, W4S-3 Inox Glass, W9, W11-2, W12-3, W12-2 Laser, W12G, W12 Teflon, W16, W250, W250-2, PowerProx, W11G-2, TranspaTect, WTT12, UC12, P250, G6 Inox, W4S, W4SL-3V, W4SLG-3V, W4SL-3H</li> </ul>	BEF-KHS-N02	2051608
	<ul style="list-style-type: none"> <li><b>Description:</b> Mounting bracket: horizontal sending axis for ceiling or floor installation or vertical sending axis for wall installation, steel, zinc coated, incl. mounting material</li> <li><b>Material:</b> Steel</li> <li><b>Details:</b> Steel, zinc coated</li> <li><b>Items supplied:</b> Mounting hardware for the sensor included</li> </ul>	BEF-WN-DX35	2069592

	Brief description	Type	part no.
connectors and cables			
	<ul style="list-style-type: none"> <li><b>Description:</b> Sensor/actuator cable, unshielded</li> <li><b>Connection type head A:</b> Female connector, M12, 5-pin, straight, A-coded</li> <li><b>Connection type head B:</b> Male connector, M12, 5-pin, straight, A-coded</li> <li><b>Signal type:</b> Sensor/actuator cable</li> <li><b>Cable:</b> 2 m, 5-wire, PUR, halogen-free</li> <li><b>Application:</b> Drag chain operation, Zones with oils and lubricants, Robot, Drag chain operation</li> </ul>	YF2A15-020UB5M2A15	2096009
	<ul style="list-style-type: none"> <li><b>Description:</b> Sensor/actuator cable, unshielded</li> <li><b>Connection type head A:</b> Female connector, M12, 5-pin, angled, A-coded</li> <li><b>Connection type head B:</b> Flying leads</li> <li><b>Signal type:</b> Sensor/actuator cable</li> <li><b>Cable:</b> 2 m, 5-wire, PVC</li> <li><b>Application:</b> Uncontaminated zones, Zones with chemicals</li> </ul>	YG2A15-020VB5XLEAX	2096215
	<ul style="list-style-type: none"> <li><b>Description:</b> Sensor/actuator cable, unshielded</li> <li><b>Connection type head A:</b> Female connector, M12, 5-pin, straight, A-coded</li> <li><b>Connection type head B:</b> Flying leads</li> <li><b>Signal type:</b> Sensor/actuator cable</li> <li><b>Cable:</b> 2 m, 5-wire, PVC</li> <li><b>Application:</b> Uncontaminated zones, Zones with chemicals</li> </ul>	YF2A15-020VB5XLEAX	2096239
	<ul style="list-style-type: none"> <li><b>Description:</b> Sensor/actuator cable, unshielded</li> <li><b>Connection type head A:</b> Female connector, M12, 5-pin, angled, A-coded</li> <li><b>Connection type head B:</b> Flying leads</li> <li><b>Signal type:</b> Sensor/actuator cable</li> <li><b>Cable:</b> 0.6 m, 5-wire, PVC</li> <li><b>Application:</b> Uncontaminated zones, Zones with chemicals</li> </ul>	YG2A15-C60VB5XLEAX	2145573
	<ul style="list-style-type: none"> <li><b>Description:</b> Sensor/actuator cable, unshielded</li> <li><b>Connection type head A:</b> Female connector, M12, 5-pin, angled, A-coded</li> <li><b>Connection type head B:</b> Flying leads</li> <li><b>Signal type:</b> Sensor/actuator cable</li> <li><b>Cable:</b> 1 m, 5-wire, PVC</li> <li><b>Application:</b> Uncontaminated zones, Zones with chemicals</li> </ul>	YG2A15-010VB5XLEAX	2145574
	<ul style="list-style-type: none"> <li><b>Description:</b> Sensor/actuator cable, unshielded</li> <li><b>Connection type head A:</b> Female connector, M12, 5-pin, angled, A-coded</li> <li><b>Connection type head B:</b> Flying leads</li> <li><b>Signal type:</b> Sensor/actuator cable</li> <li><b>Cable:</b> 3 m, 5-wire, PVC</li> <li><b>Application:</b> Uncontaminated zones, Zones with chemicals</li> </ul>	YG2A15-030VB5XLEAX	2145575
	<ul style="list-style-type: none"> <li><b>Description:</b> Sensor/actuator cable, unshielded</li> <li><b>Connection type head A:</b> Female connector, M12, 5-pin, straight, A-coded</li> <li><b>Connection type head B:</b> Flying leads</li> <li><b>Signal type:</b> Sensor/actuator cable</li> <li><b>Cable:</b> 0.6 m, 5-wire, PVC</li> <li><b>Application:</b> Uncontaminated zones, Zones with chemicals</li> </ul>	YF2A15-C60VB5XLEAX	2145570
	<ul style="list-style-type: none"> <li><b>Description:</b> Sensor/actuator cable, unshielded</li> <li><b>Connection type head A:</b> Female connector, M12, 5-pin, straight, A-coded</li> <li><b>Connection type head B:</b> Flying leads</li> <li><b>Signal type:</b> Sensor/actuator cable</li> <li><b>Cable:</b> 3 m, 5-wire, PVC</li> <li><b>Application:</b> Uncontaminated zones, Zones with chemicals</li> </ul>	YF2A15-030VB5XLEAX	2145572
device protection and care			
	<ul style="list-style-type: none"> <li><b>Description:</b> Weather protection hood for Dx35 / Dx50 / Dx50-2 / Dx80</li> </ul>	OBW-KHS-M02	2050205

## SICK AT A GLANCE

SICK is one of the leading manufacturers of intelligent sensors and sensor solutions for industrial applications. A unique range of products and services creates the perfect basis for controlling processes securely and efficiently, protecting individuals from accidents and preventing damage to the environment.

We have extensive experience in a wide range of industries and understand their processes and requirements. With intelligent sensors, we can deliver exactly what our customers need. In application centers in Europe, Asia and North America, system solutions are tested and optimized in accordance with customer specifications. All this makes us a reliable supplier and development partner.

Comprehensive services complete our offering: SICK LifeTime Services provide support throughout the machine life cycle and ensure safety and productivity.

For us, that is “Sensor Intelligence.”

## WORLDWIDE PRESENCE:

Contacts and other locations –[www.sick.com](http://www.sick.com)