



VSPP-5F2413

Inspector

2D MACHINE VISION

SICK
Sensor Intelligence.



Ordering information

| Type | part no. |
|------------|----------|
| VSP-5F2413 | 1057303 |

Other models and accessories → www.sick.com/Inspector

Detailed technical data

Features

| | |
|--|---|
| Technology | 2D snapshot |
| Configurable | ✓ |
| Toolkit | Object Locator Pixel Counter Edge Pixel Counter Pattern Blob Finder Polygon |
| Image sensor | CMOS monochrome |
| Optical focus | Adjustable focus (manual) |
| Calibration | Perspective and lens distortion correction, mm results |
| Working range | ≥ 50 mm |
| Operating distance with internal illumination | 50 mm ... 200 mm |
| Field of view of internal illumination | 22 mm x 15 mm ... 79 mm x 58 mm |
| Illumination | Integrated |
| Illumination color | Infrared |
| LED class | Risk-free group (no danger, IEC62471: 2006) |
| Spectral range | Approx. 370 nm ... 900 nm |
| Offline support | Emulator |
| Lens | S-mount |
| | Optical format 1/3" |
| | Focal length 10 mm |
| Task | Detecting - Standard objects Measuring - Dimension, contour and volume Measuring - Number Identifying - OCR Identifying - Pattern |

Determining position - 2D position determination

Mechanics/electronics

| | |
|-------------------------------|---|
| Supply voltage | 24 V DC, $\pm 20\%$ |
| Ripple | $< 5 V_{pp}$ |
| Current consumption | $\leq < 450\text{ mA}$ Without output load |
| Enclosure rating | IP67 ¹⁾ |
| Housing material | Aluminum |
| Window material | PMMA |
| Weight | 350 g |
| Dimensions (L x W x H) | 100 mm x 53 mm x 38 mm |

¹⁾ With front window mounted.

Performance

| | |
|------------------------------|--------------------------|
| Sensor properties | |
| Sensor resolution | 640 px x 480 px (0.3 MP) |
| Scan/frame rate | 40 fps ¹⁾ |
| Number of inspections | 32 |
| Reference images | 32 objects |

¹⁾ Max. 200 fps.

Interfaces

| | |
|-----------------------------------|---|
| EtherNet/IP™ | ✓ |
| Data transmission rate | 100 Mbit/s |
| Operator interfaces | Inspector Viewer, web server |
| Configuration software | SOPAS ET |
| Data storage and retrieval | Log for 30 images, record images on PC, store images to FTP |
| Ethernet communication | Web API |
| Digital input | 4 inputs (24 V) |
| Configurable inputs | External trigger, encoder input, External teach, reference object selection |
| Digital output | 3 digital outputs, 24 V (B-type) |
| Configurable outputs | Output by logical expressions, Additional image storage possibility via FTP |
| Output current | $\leq 100\text{ mA}$ |
| Standard outputs | No object detected, Everything OK, Detail error |
| Maximum encoder frequency | Max. 40 kHz |
| External illumination | 5 V TTL |
| I/O box extension | 5 x inputs for object selection, 16 outputs |

Ambient data

| | |
|--------------------------------------|-------------------------------|
| Shock load | EN 60068-2-27 |
| Vibration load | IEC 60068-2-6 |
| Ambient operating temperature | 0 °C ... +45 °C ¹⁾ |

¹⁾ Relative humidity: 35% ... 85%, 95% in storage.

| | |
|----------------------------|---------------------------------|
| Storage temperature | -20 °C ... +70 °C ¹⁾ |
|----------------------------|---------------------------------|

¹⁾ Relative humidity: 35% ... 85%, 95% in storage.

Certificates

| | |
|--|---|
| EU declaration of conformity | ✓ |
| ACMA declaration of conformity | ✓ |
| China RoHS | ✓ |
| cULus certificate | ✓ |
| Information according to Art. 3 of Data Act (Regulation EU 2023/2854) | ✓ |

Classifications

| | |
|-----------------------|----------|
| ECLASS 5.0 | 27310205 |
| ECLASS 5.1.4 | 27310205 |
| ECLASS 6.0 | 27310205 |
| ECLASS 6.2 | 27310205 |
| ECLASS 7.0 | 27310205 |
| ECLASS 8.0 | 27310205 |
| ECLASS 8.1 | 27310205 |
| ECLASS 9.0 | 27310205 |
| ECLASS 10.0 | 27310205 |
| ECLASS 11.0 | 27310205 |
| ECLASS 12.0 | 27310205 |
| ETIM 5.0 | EC001820 |
| ETIM 6.0 | EC001820 |
| ETIM 7.0 | EC001820 |
| ETIM 8.0 | EC001820 |
| UNSPSC 16.0901 | 43211731 |

Dimensional drawing Standard

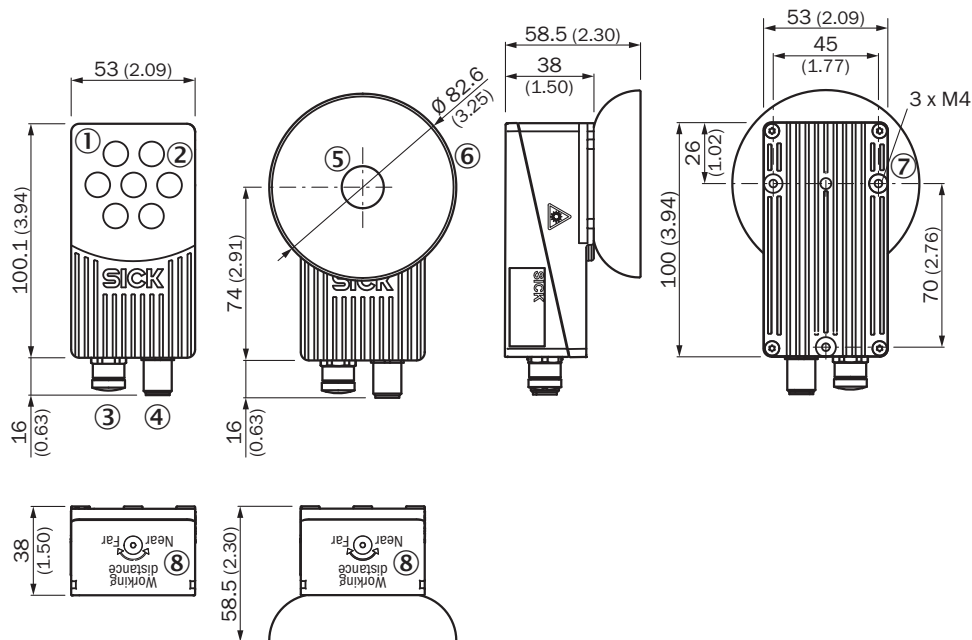

Dimensions in mm (inch)

- ① Front screen: standard, flex
- ② ring lighting
- ③ Ethernet connection M12, 4-pin, female
- ④ Power connection M12, 12-pin, male
- ⑤ Front screen: dome
- ⑥ dome light
- ⑦ Mounting hole M4
- ⑧ focus

Field of view

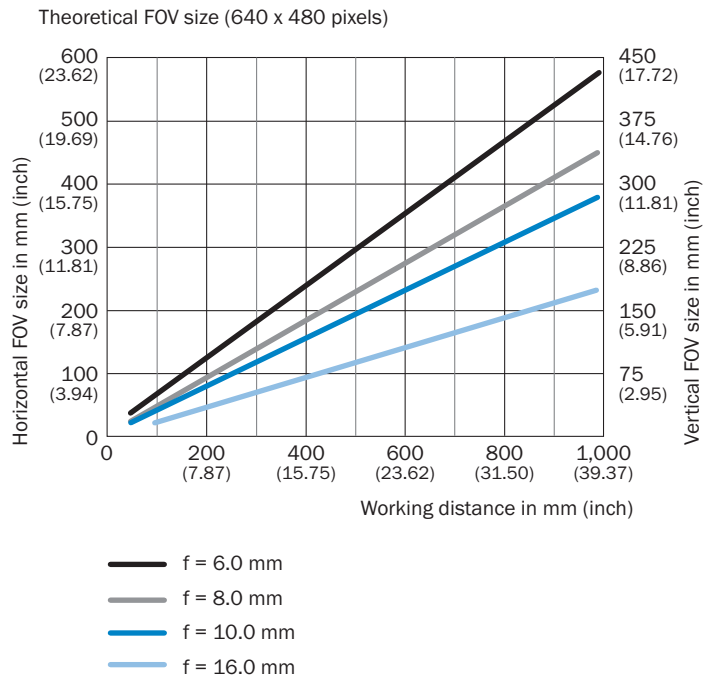

Connection type

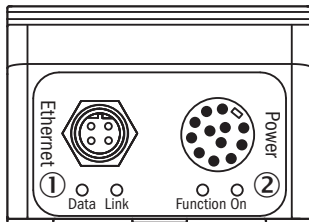

- ① Ethernet connection M12, 4-pin, female
- ② Power connection M12, 12-pin, male

Ethernet connection diagram

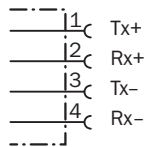



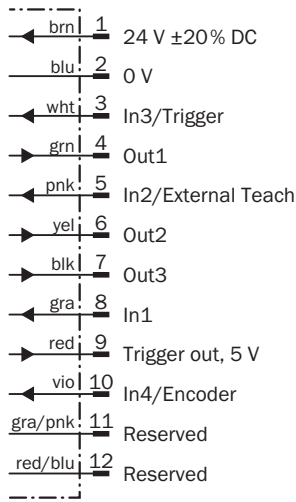



M12 connection diagram, 12-pin



Recommended accessories

Other models and accessories → www.sick.com/Inspector

| | Brief description | Type | part no. |
|---|--|-------------------------------------|----------|
| reflectors and optics | | | |
|  | <ul style="list-style-type: none"> Description: Visible block filter for variants with exchangeable lens and front window, PMMA | Inspector Flex visible block filter | 2073707 |
|  | <ul style="list-style-type: none"> Description: Visible block filter for variants with exchangeable lens and front window, glass | Inspector Flex visible block filter | 2071856 |
|  | <ul style="list-style-type: none"> Description: Exchangeable lens, focal length 6 mm | OBJ-B06025BA | 2049668 |
|  | <ul style="list-style-type: none"> Description: Exchangeable lens, focal length 16 mm, including spacer ring | OBJ-B16018BA | 2049418 |
| connectors and cables | | | |
|  | <ul style="list-style-type: none"> Connection type head A: Male connector, M12, 4-pin, straight, D-coded Connection type head B: Male connector, RJ45, 4-pin, straight Signal type: Ethernet, PROFINET Cable: 2 m, 4-wire, PUR, halogen-free Description: Ethernet, shielded, PROFINET Application: Drag chain operation, Zones with oils and lubricants | YM2D24-020P-N1MRJA4 | 2106182 |
|  | <ul style="list-style-type: none"> Description: Sensor/actuator cable, shielded Connection type head A: Female connector, M12, 12-pin, straight, A-coded Connection type head B: Flying leads Signal type: Sensor/actuator cable Cable: 5 m, 12-wire, PUR, halogen-free Application: Drag chain operation, Zones with oils and lubricants, Robot, Drag chain operation | YF2A2B-050UD2XLEAX | 2130999 |

SICK AT A GLANCE

SICK is one of the leading manufacturers of intelligent sensors and sensor solutions for industrial applications. A unique range of products and services creates the perfect basis for controlling processes securely and efficiently, protecting individuals from accidents and preventing damage to the environment.

We have extensive experience in a wide range of industries and understand their processes and requirements. With intelligent sensors, we can deliver exactly what our customers need. In application centers in Europe, Asia and North America, system solutions are tested and optimized in accordance with customer specifications. All this makes us a reliable supplier and development partner.

Comprehensive services complete our offering: SICK LifeTime Services provide support throughout the machine life cycle and ensure safety and productivity.

For us, that is “Sensor Intelligence.”

WORLDWIDE PRESENCE:

Contacts and other locations –www.sick.com