





### Ordering information

Type	part no.
CLV632-3000F0	1056858

Other models and accessories → [www.sick.com/CLV63x](http://www.sick.com/CLV63x)



### Detailed technical data

#### Features

<b>Version</b>	Short Range
<b>Connection type</b>	Cable
<b>Reading field</b>	Side (105°)
<b>Sensor type</b>	Raster scanner
<b>Optical focus</b>	Fixed focus
<b>Light source</b>	Light spot, laser, Visible, Red, 655 nm
<b>Light spot</b>	Circular
<b>Laser class</b>	2, complies with 21 CFR 1040.10 except for the conformance according to "Laser Notice No. 56" from May 8, 2019 (EN 60825-1:2014+A11:2021, IEC 60825-1:2014)
<b>Aperture angle</b>	≤ 50°
<b>Reading distance</b>	44 mm ... 256 mm <sup>1)</sup>
<b>Scanning frequency</b>	400 Hz ... 1,200 Hz
<b>Code resolution</b>	0.2 mm ... 0.5 mm
<b>Raster height, number of lines, at distance</b>	15 mm, 8, 185 mm
<b>Heating</b>	✓
<b>Cold storage applications</b>	✓

<sup>1)</sup> For details see reading field diagram.

#### Mechanics/electronics

<b>Connection type</b>	1 x 15-pin D-Sub HD male connector (0.9 m) 1 x cable, open-ended, 3-wire (2 m)
------------------------	---

<sup>1)</sup> At 25 °C.

<b>Supply voltage</b>	≤ 24 V DC, ± 10 %
<b>Power consumption</b>	40 W
<b>Housing material</b>	Aluminum die cast
<b>Housing color</b>	Light blue (RAL 5012)
<b>Window material</b>	Glass
<b>Enclosure rating</b>	IP65 (EN 60529)
<b>Protection class</b>	III (EN 61140)
<b>Weight</b>	540 g, with connecting cable
<b>Dimensions (L x W x H)</b>	80 mm x 96 mm x 50 mm
<b>MTBF</b>	100,000 h
<b>MTTF</b>	40,000 h (Laser diode) <sup>1)</sup>

<sup>1)</sup> At 25 °C.

## Performance

<b>Readable code structures</b>	1D codes
<b>Bar code types</b>	All current code types, Code 39, Code 128, Code 93, Codabar, GS1-128 / EAN 128, UPC / GTIN / EAN, Interleaved 2 of 5, Pharmacode, GS1 DataBar, Telepen, MSI/Plessey
<b>Code printing process</b>	Label (printed codes)
<b>Print ratio</b>	2:1 ... 3:1
<b>No. of codes per scan</b>	1 ... 20 (Standard decoder) 1 ... 6 (SMART decoder)
<b>No. of codes per reading interval</b>	1 ... 50 (auto-discriminating)
<b>No. of characters per reading interval</b>	5,000 500 (for multiplexer function in CAN operation)
<b>No. of multiple readings</b>	1 ... 99

## Interfaces

<b>PROFINET</b>	✓
Type of fieldbus integration	Optional over external fieldbus module CDF600-2
Function	PROFINET Single Port, PROFINET Dual Port
<b>EtherCAT®</b>	✓
Type of fieldbus integration	Optional over external fieldbus module CDF600
<b>Serial</b>	✓, RS-232, RS-422, RS-485
Function	Data interface (read result output), Service interface
Data transmission rate	2,400 Baud ... 115.2 kBaud, AUX: 57.6 kBaud (RS-232)
<b>CAN</b>	✓
Function	SICK CAN sensor network CSN (CAN controller/CAN device, multiplexer/server)
Data transmission rate	20 kbit/s ... 1 Mbit/s
<b>CANopen</b>	✓
Data transmission rate	20 kbit/s ... 1 Mbit/s
<b>PROFIBUS DP</b>	✓
Type of fieldbus integration	Optional over external fieldbus module CDF600-2
<b>Digital inputs</b>	4 ("Sensor 1", "Sensor 2", 2 inputs via optional parameter storage CMC600 in CDB620/CDM420)

<b>Digital outputs</b>	4 ("Result 1", "Result 2", 2 outputs via optional parameter storage CMC600 in CDB620/CDM420)
<b>Reading pulse</b>	Digital inputs, non-powered, serial interface, auto pulse, CAN
<b>Optical indicators</b>	6 LEDs (Ready, Result, laser, Data, CAN, LNK TX, Bar graph for displaying the reading rate percentage (10 LEDs))
<b>Acoustic indicators</b>	Beeper/buzzer (can be switched off, can be allocated as a result indication function)
<b>Control elements</b>	2 buttons (choose and start/stop functions)
<b>Configuration software</b>	SOPAS ET
<b>Memory card</b>	MicroSD memory card (flash card), optional

#### Ambient data

<b>Electromagnetic compatibility (EMC)</b>	EN 61000-6-3 (2001-10) / EN 61000-6-2:2005
<b>Vibration resistance</b>	EN 60068-2-6 (1995)
<b>Shock resistance</b>	EN 60068-2-27 (1993)
<b>Ambient operating temperature</b>	-35 °C ... +35 °C
<b>Storage temperature</b>	-20 °C ... +70 °C
<b>Relative humidity</b>	90 %, Non-condensing
<b>Ambient light immunity</b>	2,000 lx, on barcode
<b>Bar code print contrast (PCS)</b>	≥ 60 %

#### General notes

<b>Note on use</b>	For Ethernet connection please use an Ethernet version of CLV6xx
--------------------	--

#### Certificates

<b>EU declaration of conformity</b>	✓
<b>UK declaration of conformity</b>	✓
<b>ACMA declaration of conformity</b>	✓
<b>China RoHS</b>	✓
<b>cULus certificate</b>	✓
<b>Ethercat certificate</b>	✓
<b>Profinet certificate</b>	✓
<b>Laser safety (IEC 60825-1) declaration of manufacturer</b>	✓
<b>Information according to Art. 3 of Data Act (Regulation EU 2023/2854)</b>	✓
<b>4Dpro</b>	✓

#### Classifications

<b>ECLASS 5.0</b>	27280102
<b>ECLASS 5.1.4</b>	27280102
<b>ECLASS 6.0</b>	27280102
<b>ECLASS 6.2</b>	27280102
<b>ECLASS 7.0</b>	27280102
<b>ECLASS 8.0</b>	27280102
<b>ECLASS 8.1</b>	27280102
<b>ECLASS 9.0</b>	27280102

<b>ECLASS 10.0</b>	27280102
<b>ECLASS 11.0</b>	27280102
<b>ECLASS 12.0</b>	27280102
<b>ETIM 5.0</b>	EC002550
<b>ETIM 6.0</b>	EC002550
<b>ETIM 7.0</b>	EC002550
<b>ETIM 8.0</b>	EC002550
<b>UNSPSC 16.0901</b>	43211701

Dimensional drawing

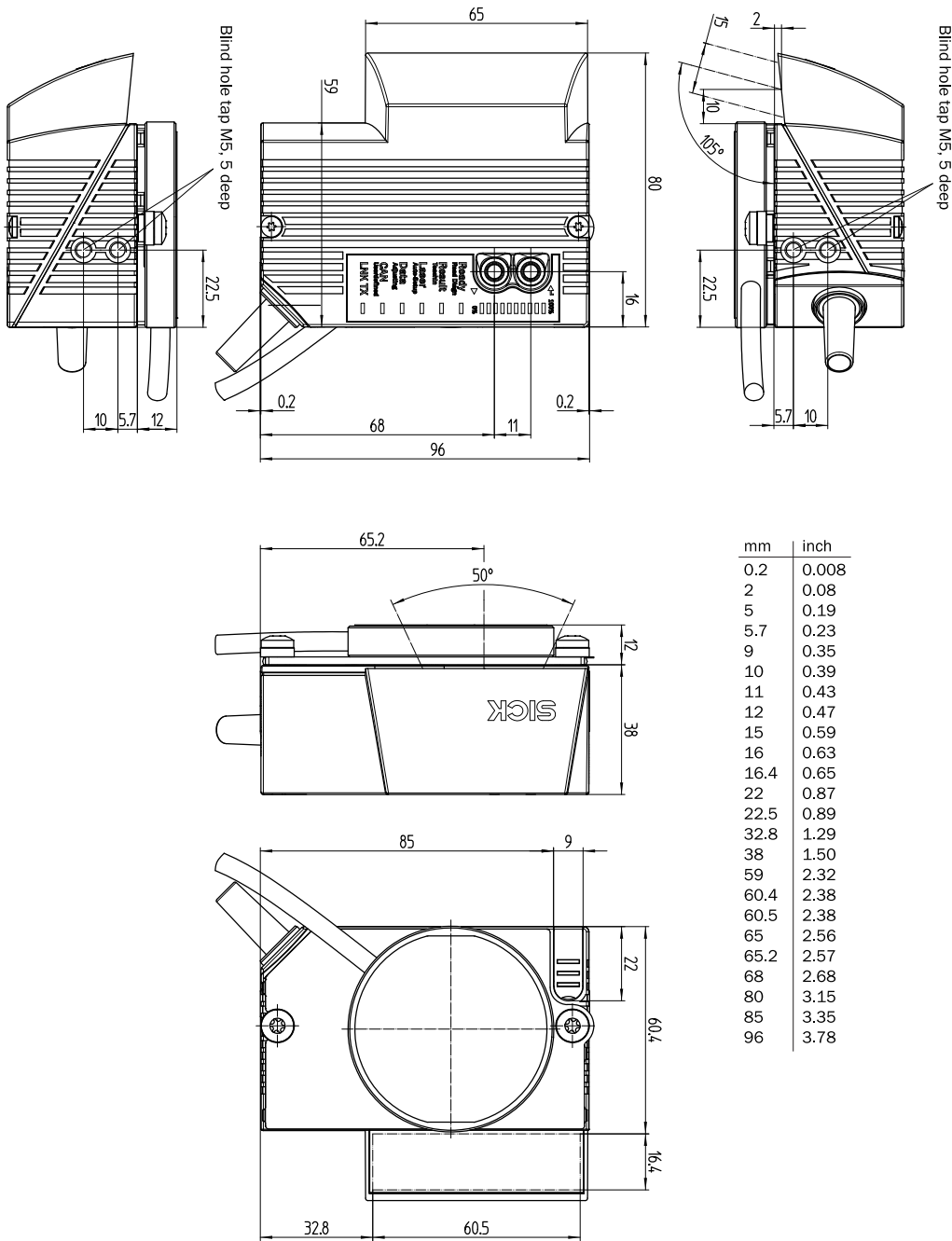

Dimensions in mm (inch)

## Reading field diagram

Reading field height in mm (inch)

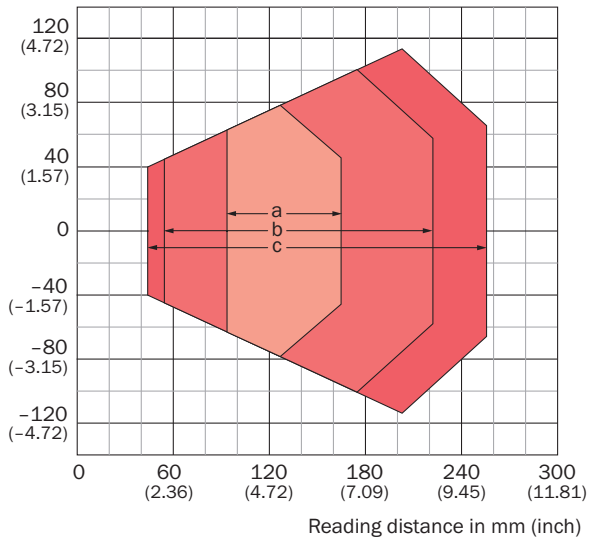







### Resolution

- a: 0.20 mm (7.9 mil)
- b: 0.35 mm (13.8 mil)
- c: 0.50 mm (19.7 mil)

## Recommended accessories

Other models and accessories → [www.sick.com/CLV63x](http://www.sick.com/CLV63x)

	Brief description	Type	part no.
<b>Junction boxes</b>			
		CDB620-001	1042256
		CDM420-0001	1025362
<b>Mounting systems</b>			
	<ul style="list-style-type: none"> <li><b>Description:</b> Hanger-shaped mounting bracket, thermally isolated for use with heating devices</li> <li><b>Items supplied:</b> Mounting hardware included</li> </ul>	Mounting bracket	2050705
<b>device protection and care</b>			
	<ul style="list-style-type: none"> <li><b>Product family:</b> Heating devices</li> <li><b>Description:</b> Additional board for connecting a bar code scanner with heater in combination with CDM-420</li> </ul>	Additional board	2055071
<b>integration modules and adapters</b>			
	<ul style="list-style-type: none"> <li><b>Description:</b> External parameter memory for integration in CDB620/CDB650/CDM42x</li> </ul>	CMC600-101	1042259

	Brief description	Type	part no.
Storage media			
	<ul style="list-style-type: none"><li><b>Description:</b> microSD memory card with 1 GB for industrial use</li></ul>	microSD memory card	4051366

## SICK AT A GLANCE

SICK is one of the leading manufacturers of intelligent sensors and sensor solutions for industrial applications. A unique range of products and services creates the perfect basis for controlling processes securely and efficiently, protecting individuals from accidents and preventing damage to the environment.

We have extensive experience in a wide range of industries and understand their processes and requirements. With intelligent sensors, we can deliver exactly what our customers need. In application centers in Europe, Asia and North America, system solutions are tested and optimized in accordance with customer specifications. All this makes us a reliable supplier and development partner.

Comprehensive services complete our offering: SICK LifeTime Services provide support throughout the machine life cycle and ensure safety and productivity.

For us, that is “Sensor Intelligence.”

## WORLDWIDE PRESENCE:

Contacts and other locations –[www.sick.com](http://www.sick.com)