



CLV690-0010

CLV69x

FIXED MOUNT BARCODE SCANNERS

SICK
Sensor Intelligence.



Ordering information

Type	part no.
CLV690-0010	1056614

Other models and accessories → www.sick.com/CLV69x



Detailed technical data

Features

Version	Standard Density
Connection type	Depending on the cloning plug used
Reading field	Front
Sensor type	Line scanner
Optical focus	Auto focus (alternative: dynamic focus control)
No. of distance configurations	≤ 8
Focus adjustment time	≤ 20 ms
Focus trigger source	Data interface / Digital inputs
Light source	Light spot, laser, Visible, Red, 660 nm
Laser class	2, complies with 21 CFR 1040.10 except for the conformance according to "Laser Notice No. 56" from May 8, 2019 (EN 60825-1:2014+A11:2021, IEC 60825-1:2014)
Aperture angle	≤ 60°
Reading distance	500 mm ... 2,100 mm ¹⁾
Scanning frequency	400 Hz ... 1,200 Hz
Code resolution	0.3 mm ... 1 mm

¹⁾ For details see reading field diagram.

Mechanics/electronics

Connection type	Depending on the cloning plug used
Supply voltage	18 V DC ... 30 V DC
Power consumption	15 W
Housing material	Aluminum die cast

¹⁾ At 25 °C.

Housing color	Light blue (RAL 5012)
Window material	Plastic
Enclosure rating	IP65 (EN 60529/A1 (2002-02))
Weight	1,500 g
Dimensions (L x W x H)	117 mm x 117 mm x 94 mm
MTBF	100,000 h
MTTF	40,000 h (Laser diode) ¹⁾

¹⁾ At 25 °C.

Performance

Readable code structures	1D codes
Bar code types	Interleaved 2 of 5, all current code types, Codabar, Code 128, Code 39, Code 93, GS1-128 / EAN 128, UPC / GTIN / EAN
Code printing process	Label (printed codes)
Print ratio	2:1 ... 3:1
No. of codes per scan	1 ... 20 (Standard decoder) 1 ... 6 (SMART decoder)
No. of codes per reading interval	1 ... 50 (auto-discriminating)
No. of characters per reading interval	5,000
No. of multiple readings	1 ... 100

Interfaces

Ethernet		✓ , TCP/IP
	Remark	Only with cloning plug I/O, CAN IN/OUT or CAN Redundant
	Function	Data interface (read result output), Service interface
	Data transmission rate	10/100 MBit/s
PROFINET		✓
	Type of fieldbus integration	Optional over external fieldbus module CDF600-2
	Remark	Only with cloning plug I/O, CAN IN/OUT or CAN Redundant
	Function	PROFINET Single Port, PROFINET Dual Port
EtherNet/IP™		✓
	Remark	Only with cloning plug I/O, CAN IN/OUT or CAN Redundant
	Data transmission rate	10/100 MBit/s
Serial		✓ , RS-232, RS-422, RS-485
	Remark	Only with cloning plug D-Sub and Ethernet
	Function	Data interface (read result output), AUX (only RS-232)
	Data transmission rate	0.3 kBaud ... 115.2 kBaud, AUX: 57.6 kBaud (RS-232)
CAN		✓
	Function	SICK CAN sensor network CSN (CAN controller/CAN device, multiplexer/server)
	Data transmission rate	20 kbit/s ... 1 Mbit/s
PROFIBUS DP		✓
Type of fieldbus integration	Optional over external fieldbus module CDF600-2	
Digital inputs		6 ("Sensor 1" ... "Sensor 6")
Digital outputs		4 ("Result 1" ... "Result 4")

Reading pulse	Digital inputs, serial interface, auto pulse, CAN
Optical indicators	6 LEDs (Ready, Result, laser, Data, CAN, LNK TX, Bar graph for displaying the reading rate percentage (10 LEDs))
Control elements	2 buttons
Parameter storage	Integrated in cloning plug
Configuration software	SOPAS ET

Ambient data

Electromagnetic compatibility (EMC)	EN 61000-6-4 (2007-01) + A1 (2011) / EN 61000-6-2:2005-08
Vibration resistance	EN 60068-2-6:2008-02
Shock resistance	EN 60068-2-27:2009-05
Ambient operating temperature	0 °C ... +40 °C
Storage temperature	-20 °C ... +70 °C
Relative humidity	90 %, Non-condensing
Ambient light immunity	2,000 lx, on barcode
Bar code print contrast (PCS)	≥ 60 %

General notes

Note on use	Standard device with front reading window made of plastic designed for the food industry
--------------------	--

Certificates

EU declaration of conformity	✓
UK declaration of conformity	✓
ACMA declaration of conformity	✓
China RoHS	✓
cULus certificate	✓
Profinet certificate	✓
BIS registration	✓
Laser safety (IEC 60825-1) declaration of manufacturer	✓
Information according to Art. 3 of Data Act (Regulation EU 2023/2854)	✓
4Dpro	✓

Classifications

ECLASS 5.0	27280102
ECLASS 5.1.4	27280102
ECLASS 6.0	27280102
ECLASS 6.2	27280102
ECLASS 7.0	27280102
ECLASS 8.0	27280102
ECLASS 8.1	27280102
ECLASS 9.0	27280102
ECLASS 10.0	27280102
ECLASS 11.0	27280102

ECLASS 12.0	27280102
ETIM 5.0	EC002550
ETIM 6.0	EC002550
ETIM 7.0	EC002550
ETIM 8.0	EC002550
UNSPSC 16.0901	43211701

Dimensional drawing

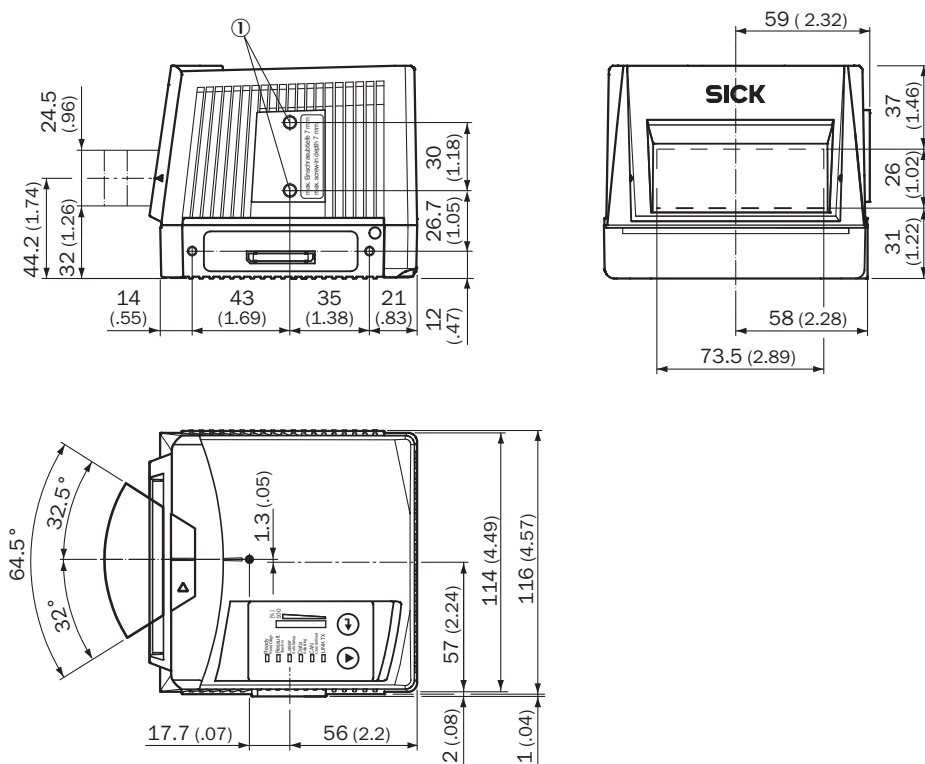

Dimensions in mm (inch)



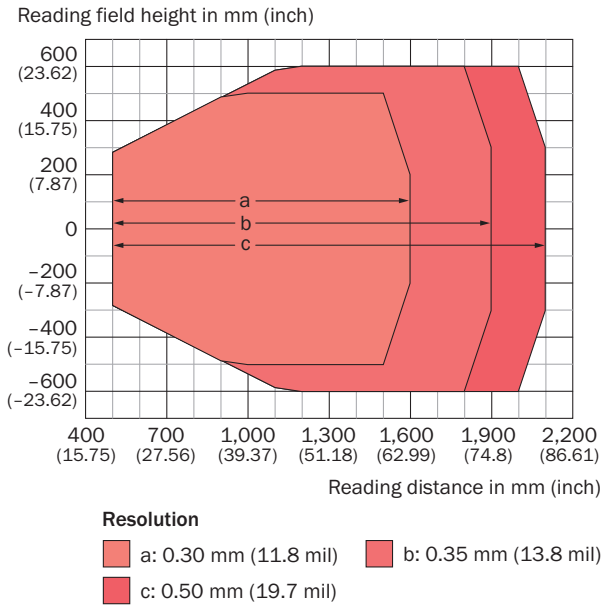

① M6 blind tapped holes, 7 mm deep (2 x), for mounting



Reading field diagram



Recommended accessories

Other models and accessories → www.sick.com/CLV69x

	Brief description	Type	part no.
Mounting systems			
	<ul style="list-style-type: none"> Description: Quick-action lock system Items supplied: Mounting hardware included 	Quick release	2016110
	<ul style="list-style-type: none"> Description: Mounting support with integrated vibration/shock absorption for suspended mounting (absorber elements above the CLV) Suitable for: CLV69x 	Mounting bracket with vibration/shock absorption for CLV69x	2088163
connectors and cables			
	<ul style="list-style-type: none"> Connection type head A: Male connector, M12, 17-pin, Male connector, M12, 5-pin, Female connector, M12, 4-pin Signal type: Power, Ethernet, serial, CAN, digital I/Os Items supplied: With three M12 round connectors (17-pin male connector, 4-pin Ethernet female connector, 5-pin CAN male connector) Description: Power, Ethernet, Serial, CAN, Digital I/Os Note: Plug housing I/O, Ethernet 	Cloning plug	2062452
	<ul style="list-style-type: none"> Connection type head A: Female connector, M12, 17-pin, straight, A-coded Connection type head B: Male connector, M12, 17-pin, straight, A-coded Signal type: Power, serial, CAN, digital I/Os Cable: 2 m, suitable for refrigeration Description: Power, suitable for 2 A, shielded, Serial, CAN, Digital I/Os 	YM2A8D-020XXXF2A8D	6053230
	<ul style="list-style-type: none"> Connection type head A: Male connector, M12, 4-pin, straight, D-coded Connection type head B: Male connector, RJ45, 4-pin, straight Signal type: Ethernet, PROFINET Cable: 2 m, 4-wire, PUR, halogen-free Description: Ethernet, shielded, PROFINET Application: Drag chain operation, Zones with oils and lubricants 	YM2D24-020P-N1MRJA4	2106182

	Brief description	Type	part no.
Junction boxes			
		CDB650-204	1064114
integration modules and adapters			
	<ul style="list-style-type: none"> Description: External parameter memory for integration in CDB620/CDB650/CDM42x 	CMC600-101	1042259

SICK AT A GLANCE

SICK is one of the leading manufacturers of intelligent sensors and sensor solutions for industrial applications. A unique range of products and services creates the perfect basis for controlling processes securely and efficiently, protecting individuals from accidents and preventing damage to the environment.

We have extensive experience in a wide range of industries and understand their processes and requirements. With intelligent sensors, we can deliver exactly what our customers need. In application centers in Europe, Asia and North America, system solutions are tested and optimized in accordance with customer specifications. All this makes us a reliable supplier and development partner.

Comprehensive services complete our offering: SICK LifeTime Services provide support throughout the machine life cycle and ensure safety and productivity.

For us, that is “Sensor Intelligence.”

WORLDWIDE PRESENCE:

Contacts and other locations –www.sick.com