



**CLV692-0000**

CLV69x

**FIXED MOUNT BARCODE SCANNERS**

**SICK**  
Sensor Intelligence.



### Ordering information

Type	part no.
CLV692-0000	1056608

Other models and accessories → [www.sick.com/CLV69x](http://www.sick.com/CLV69x)



### Detailed technical data

#### Features

<b>Version</b>	High Density
<b>Connection type</b>	Depending on the cloning plug used
<b>Reading field</b>	Front
<b>Sensor type</b>	Line scanner
<b>Optical focus</b>	Auto focus (alternative: dynamic focus control)
<b>No. of distance configurations</b>	≤ 8
<b>Focus adjustment time</b>	≤ 20 ms
<b>Focus trigger source</b>	Data interface / Digital inputs
<b>Light source</b>	Light spot, laser, Visible, Red, 660 nm
<b>Laser class</b>	2, complies with 21 CFR 1040.10 except for the conformance according to "Laser Notice No. 56" from May 8, 2019 (EN 60825-1:2014+A11:2021, IEC 60825-1:2014)
<b>Aperture angle</b>	≤ 60°
<b>Reading distance</b>	400 mm ... 1,600 mm <sup>1)</sup>
<b>Scanning frequency</b>	400 Hz ... 1,200 Hz
<b>Code resolution</b>	0.17 mm ... 0.4 mm

<sup>1)</sup> For details see reading field diagram.

#### Mechanics/electronics

<b>Connection type</b>	Depending on the cloning plug used
<b>Supply voltage</b>	18 V DC ... 30 V DC
<b>Power consumption</b>	15 W
<b>Housing material</b>	Aluminum die cast

<sup>1)</sup> At 25 °C.

<b>Housing color</b>	Light blue (RAL 5012)
<b>Window material</b>	Glass
<b>Enclosure rating</b>	IP65 (EN 60529/A1 (2002-02))
<b>Weight</b>	1,500 g
<b>Dimensions (L x W x H)</b>	117 mm x 117 mm x 94 mm
<b>MTBF</b>	100,000 h
<b>MTTF</b>	40,000 h (Laser diode) <sup>1)</sup>

<sup>1)</sup> At 25 °C.

## Performance

<b>Readable code structures</b>	1D codes
<b>Bar code types</b>	Interleaved 2 of 5, all current code types, Codabar, Code 128, Code 39, Code 93, GS1-128 / EAN 128, UPC / GTIN / EAN
<b>Code printing process</b>	Label (printed codes)
<b>Print ratio</b>	2:1 ... 3:1
<b>No. of codes per scan</b>	1 ... 20 (Standard decoder) 1 ... 6 (SMART decoder)
<b>No. of codes per reading interval</b>	1 ... 50 (auto-discriminating)
<b>No. of characters per reading interval</b>	5,000
<b>No. of multiple readings</b>	1 ... 100

## Interfaces

<b>Ethernet</b>		✓ , TCP/IP
	Remark	Only with cloning plug I/O, CAN IN/OUT or CAN Redundant
	Function	Data interface (read result output), Service interface
	Data transmission rate	10/100 MBit/s
<b>PROFINET</b>		✓
	Type of fieldbus integration	Optional over external fieldbus module CDF600-2
	Remark	Only with cloning plug I/O, CAN IN/OUT or CAN Redundant
	Function	PROFINET Single Port, PROFINET Dual Port
<b>EtherNet/IP™</b>		✓
	Remark	Only with cloning plug I/O, CAN IN/OUT or CAN Redundant
	Data transmission rate	10/100 MBit/s
<b>Serial</b>		✓ , RS-232, RS-422, RS-485
	Remark	Only with cloning plug D-Sub and Ethernet
	Function	Data interface (read result output), AUX (only RS-232)
	Data transmission rate	0.3 kBaud ... 115.2 kBaud, AUX: 57.6 kBaud (RS-232)
<b>CAN</b>		✓
	Function	SICK CAN sensor network CSN (CAN controller/CAN device, multiplexer/server)
	Data transmission rate	20 kbit/s ... 1 Mbit/s
<b>PROFIBUS DP</b>		✓
	Type of fieldbus integration	Optional over external fieldbus module CDF600-2
<b>Digital inputs</b>		6 ("Sensor 1" ... "Sensor 6")
<b>Digital outputs</b>		4 ("Result 1" ... "Result 4")

<b>Reading pulse</b>	Digital inputs, serial interface, auto pulse, CAN
<b>Optical indicators</b>	6 LEDs (Ready, Result, laser, Data, CAN, LNK TX, Bar graph for displaying the reading rate percentage (10 LEDs))
<b>Control elements</b>	2 buttons
<b>Parameter storage</b>	Integrated in cloning plug
<b>Configuration software</b>	SOPAS ET

#### Ambient data

<b>Electromagnetic compatibility (EMC)</b>	EN 61000-6-4 (2007-01) + A1 (2011) / EN 61000-6-2:2005-08
<b>Vibration resistance</b>	EN 60068-2-6:2008-02
<b>Shock resistance</b>	EN 60068-2-27:2009-05
<b>Ambient operating temperature</b>	0 °C ... +40 °C
<b>Storage temperature</b>	-20 °C ... +70 °C
<b>Relative humidity</b>	90 %, Non-condensing
<b>Ambient light immunity</b>	2,000 lx, on barcode
<b>Bar code print contrast (PCS)</b>	≥ 60 %

#### Certificates

<b>EU declaration of conformity</b>	✓
<b>UK declaration of conformity</b>	✓
<b>ACMA declaration of conformity</b>	✓
<b>China RoHS</b>	✓
<b>cULus certificate</b>	✓
<b>KC Mark certificate</b>	✓
<b>Profinet certificate</b>	✓
<b>BIS registration</b>	✓
<b>Laser safety (IEC 60825-1) declaration of manufacturer</b>	✓
<b>Information according to Art. 3 of Data Act (Regulation EU 2023/2854)</b>	✓
<b>4Dpro</b>	✓

#### Classifications

<b>ECLASS 5.0</b>	27280102
<b>ECLASS 5.1.4</b>	27280102
<b>ECLASS 6.0</b>	27280102
<b>ECLASS 6.2</b>	27280102
<b>ECLASS 7.0</b>	27280102
<b>ECLASS 8.0</b>	27280102
<b>ECLASS 8.1</b>	27280102
<b>ECLASS 9.0</b>	27280102
<b>ECLASS 10.0</b>	27280102
<b>ECLASS 11.0</b>	27280102
<b>ECLASS 12.0</b>	27280102
<b>ETIM 5.0</b>	EC002550

<b>ETIM 6.0</b>	EC002550
<b>ETIM 7.0</b>	EC002550
<b>ETIM 8.0</b>	EC002550
<b>UNSPSC 16.0901</b>	43211701

Dimensional drawing

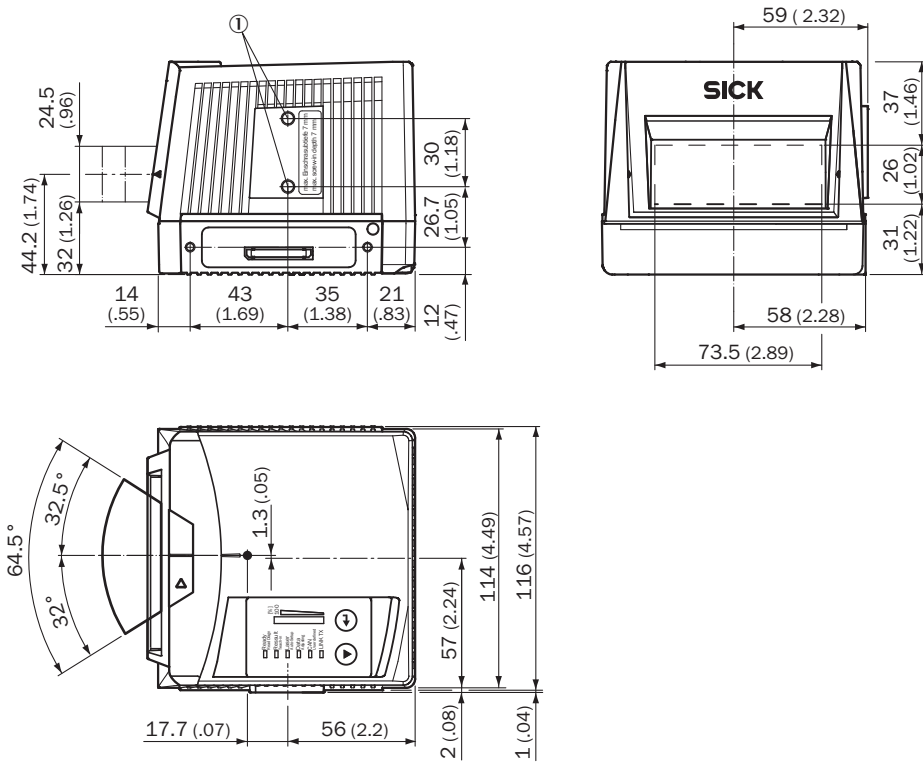

Dimensions in mm (inch)



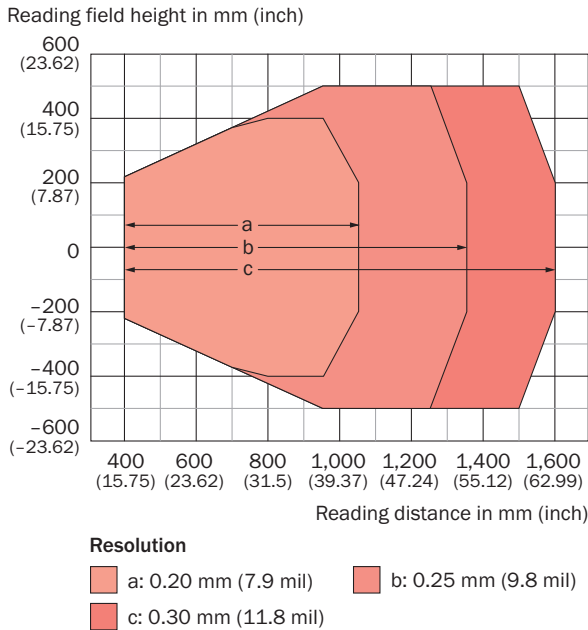

① M6 blind tapped holes, 7 mm deep (2 x), for mounting



### Reading field diagram



### Recommended accessories

Other models and accessories → [www.sick.com/CLV69x](http://www.sick.com/CLV69x)

	Brief description	Type	part no.
<b>Mounting systems</b>			
	<ul style="list-style-type: none"> <li><b>Description:</b> Quick-action lock system</li> <li><b>Items supplied:</b> Mounting hardware included</li> </ul>	Quick release	2016110
	<ul style="list-style-type: none"> <li><b>Description:</b> Mounting support with integrated vibration/shock absorption for suspended mounting (absorber elements above the CLV)</li> <li><b>Suitable for:</b> CLV69x</li> </ul>	Mounting bracket with vibration/shock absorption for CLV69x	2088163
<b>connectors and cables</b>			
	<ul style="list-style-type: none"> <li><b>Connection type head A:</b> Male connector, M12, 17-pin, Male connector, M12, 5-pin, Female connector, M12, 4-pin</li> <li><b>Signal type:</b> Power, Ethernet, serial, CAN, digital I/Os</li> <li><b>Items supplied:</b> With three M12 round connectors (17-pin male connector, 4-pin Ethernet female connector, 5-pin CAN male connector)</li> <li><b>Description:</b> Power, Ethernet, Serial, CAN, Digital I/Os</li> <li><b>Note:</b> Plug housing I/O, Ethernet</li> </ul>	Cloning plug	2062452
	<ul style="list-style-type: none"> <li><b>Connection type head A:</b> Female connector, M12, 17-pin, straight, A-coded</li> <li><b>Connection type head B:</b> Male connector, M12, 17-pin, straight, A-coded</li> <li><b>Signal type:</b> Power, serial, CAN, digital I/Os</li> <li><b>Cable:</b> 2 m, suitable for refrigeration</li> <li><b>Description:</b> Power, suitable for 2 A, shielded, Serial, CAN, Digital I/Os</li> </ul>	YM2A8D-020XXXF2A8D	6053230
	<ul style="list-style-type: none"> <li><b>Connection type head A:</b> Male connector, M12, 4-pin, straight, D-coded</li> <li><b>Connection type head B:</b> Male connector, RJ45, 4-pin, straight</li> <li><b>Signal type:</b> Ethernet, PROFINET</li> <li><b>Cable:</b> 2 m, 4-wire, PUR, halogen-free</li> <li><b>Description:</b> Ethernet, shielded, PROFINET</li> <li><b>Application:</b> Drag chain operation, Zones with oils and lubricants</li> </ul>	YM2D24-020P-N1MRJA4	2106182

	Brief description	Type	part no.
Junction boxes			
		CDB650-204	1064114
integration modules and adapters			
	<ul style="list-style-type: none"> <li><b>Description:</b> External parameter memory for integration in CDB620/CDB650/CDM42x</li> </ul>	CMC600-101	1042259

## SICK AT A GLANCE

SICK is one of the leading manufacturers of intelligent sensors and sensor solutions for industrial applications. A unique range of products and services creates the perfect basis for controlling processes securely and efficiently, protecting individuals from accidents and preventing damage to the environment.

We have extensive experience in a wide range of industries and understand their processes and requirements. With intelligent sensors, we can deliver exactly what our customers need. In application centers in Europe, Asia and North America, system solutions are tested and optimized in accordance with customer specifications. All this makes us a reliable supplier and development partner.

Comprehensive services complete our offering: SICK LifeTime Services provide support throughout the machine life cycle and ensure safety and productivity.

For us, that is “Sensor Intelligence.”

## WORLDWIDE PRESENCE:

Contacts and other locations –[www.sick.com](http://www.sick.com)