

# DFS60A-BAPD65536

DFS60

INCREMENTAL ENCODERS

**SICK**  
Sensor Intelligence.



### Ordering information

Type	part no.
DFS60A-BAPD65536	1056538

Other models and accessories → [www.sick.com/DFS60](http://www.sick.com/DFS60)

Illustration may differ



### Detailed technical data

#### Safety-related parameters

<b>MTTF<sub>D</sub> (mean time to dangerous failure)</b>	300 years (EN ISO 13849-1) <sup>1)</sup>
--	--

<sup>1)</sup> This product is a standard product and does not constitute a safety component as defined in the Machinery Directive. Calculation based on nominal load of components, average ambient temperature 40 °C, frequency of use 8760 h/a. All electronic failures are considered hazardous. For more information, see document no. 8015532.

#### Performance

<b>Pulses per revolution</b>	65,536 <sup>1)</sup>
<b>Measuring step</b>	90°, electric/pulses per revolution
<b>Measuring step deviation at binary number of lines</b>	± 0.0015°
<b>Error limits</b>	± 0.03°

<sup>1)</sup> See maximum revolution range.

#### Interfaces

<b>Communication interface</b>	Incremental
<b>Communication Interface detail</b>	TTL / HTL
<b>Factory setting</b>	Factory setting: output level TTL
<b>Number of signal channels</b>	6-channel
<b>Programmable/configurable</b>	✓
<b>Initialization time</b>	32 ms, 30 ms <sup>1)</sup>
<b>Output frequency</b>	≤ 820 kHz
<b>Load current</b>	≤ 30 mA
<b>Power consumption</b>	≤ 0.7 W (without load)

<sup>1)</sup> With mechanical zero pulse width.

## Electronics

<b>Connection type</b>	Male connector, M12, 8-pin, axial
<b>Supply voltage</b>	4.5 ... 32 V
<b>Reference signal, number</b>	1
<b>Reference signal, position</b>	90°, electric, logically gated with A and B
<b>Reverse polarity protection</b>	✓
<b>Short-circuit protection of the outputs</b>	✓ <sup>1) 2)</sup>

<sup>1)</sup> Programming TTL with  $\geq 5.5$  V: short-circuit opposite to another channel or GND permissible for maximum 30 s.

<sup>2)</sup> Programming HTL or TTL with  $< 5.5$  V: short-circuit opposite to another channel, US or GND permissible for maximum 30 s.

## Mechanics

<b>Mechanical design</b>	Blind hollow shaft
<b>Shaft diameter</b>	6 mm Front clamp
<b>Weight</b>	+ 0.2 kg
<b>Shaft material</b>	Stainless steel
<b>Flange material</b>	Aluminum
<b>Housing material</b>	Aluminum die cast
<b>Start up torque</b>	0.8 Ncm (+20 °C)
<b>Operating torque</b>	0.6 Ncm (+20 °C)
<b>Permissible movement static</b>	$\pm 0.3$ mm (radial) $\pm 0.5$ mm (axial)
<b>Permissible movement dynamic</b>	$\pm 0.05$ mm (radial) $\pm 0.01$ mm (axial)
<b>Operating speed</b>	$\leq 6,000$ min <sup>-1</sup> <sup>1)</sup>
<b>Moment of inertia of the rotor</b>	40 gcm <sup>2</sup>
<b>Bearing lifetime</b>	$3.6 \times 10^{10}$ revolutions
<b>Angular acceleration</b>	$\leq 500,000$ rad/s <sup>2</sup>

<sup>1)</sup> Allow for self-heating of 3.3 K per 1,000 rpm when designing the operating temperature range.

## Ambient data

<b>EMC</b>	According to EN 61000-6-2 and EN 61000-6-3
<b>Enclosure rating</b>	IP67, Housing side, male connector (IEC 60529) <sup>1)</sup> IP65, shaft side (IEC 60529)
<b>Permissible relative humidity</b>	90 % (Condensation not permitted)
<b>Operating temperature range</b>	-40 °C ... +100 °C <sup>2)</sup> -30 °C ... +100 °C <sup>3)</sup>
<b>Storage temperature range</b>	-40 °C ... +100 °C, without package
<b>Resistance to shocks</b>	100 g, 6 ms (EN 60068-2-27)
<b>Resistance to vibration</b>	30 g, 10 Hz ... 2,000 Hz (EN 60068-2-6)

<sup>1)</sup> With mating connector fitted.

<sup>2)</sup> Stationary position of the cable.

<sup>3)</sup> Flexible position of the cable.

## Certificates

<b>EU declaration of conformity</b>	✓
-------------------------------------	---

<b>UK declaration of conformity</b>	✓
<b>ACMA declaration of conformity</b>	✓
<b>Moroccan declaration of conformity</b>	✓
<b>China RoHS</b>	✓
<b>cULus certificate</b>	✓
<b>Information according to Art. 3 of Data Act (Regulation EU 2023/2854)</b>	✓

### Classifications

<b>ECLASS 5.0</b>	27270501
<b>ECLASS 5.1.4</b>	27270501
<b>ECLASS 6.0</b>	27270590
<b>ECLASS 6.2</b>	27270590
<b>ECLASS 7.0</b>	27270501
<b>ECLASS 8.0</b>	27270501
<b>ECLASS 8.1</b>	27270501
<b>ECLASS 9.0</b>	27270501
<b>ECLASS 10.0</b>	27270501
<b>ECLASS 11.0</b>	27270501
<b>ECLASS 12.0</b>	27270501
<b>ETIM 5.0</b>	EC001486
<b>ETIM 6.0</b>	EC001486
<b>ETIM 7.0</b>	EC001486
<b>ETIM 8.0</b>	EC001486
<b>UNSPSC 16.0901</b>	41112113



PINMale connector M12, 8-pin	PINMale connector M23, 12-pin	Wire colors (cable connection)	TTL/HTL signal	Sin/Cos 1.0 V <sub>PP</sub>	Explanation
2	5	White	A	COS+	Signal wire
3	1	Black	$\bar{B}$	SIN-	Signal wire
4	8	Pink	B	SIN+	Signal wire
5	4	Yellow	$\bar{Z}$	$\bar{Z}$	Signal wire
6	3	Purple	Z	Z	Signal wire
7	10	Blue	GND	GND	Ground connection
8	12	Red	+U <sub>S</sub>	+U <sub>S</sub>	Supply voltage
-	9	-	N.c.	N.c.	Not assigned
-	2	-	N.c.	N.c.	Not assigned
-	11	-	N.c.	N.c.	Not assigned
-	7 <sup>1)</sup>	Orange	0-SET <sup>1)</sup>	N.c.	Set zero pulse <sup>1)</sup>
Screen	Screen	Screen	Screen	Screen	Screen connected to housing on encoder side. Connected to ground on control side.

<sup>1)</sup>For electrical interfaces only: M, U, V, W with 0-SET function on PIN 7 on M23 plug. The 0-SET input is used to set the zero pulse to the current shaft position. If the 0-SET input is applied to US for longer than 250 ms after it has previously been open or applied to GND for at least 1,000 ms, the current shaft position is assigned zero pulse signal "Z".

maximum revolution range

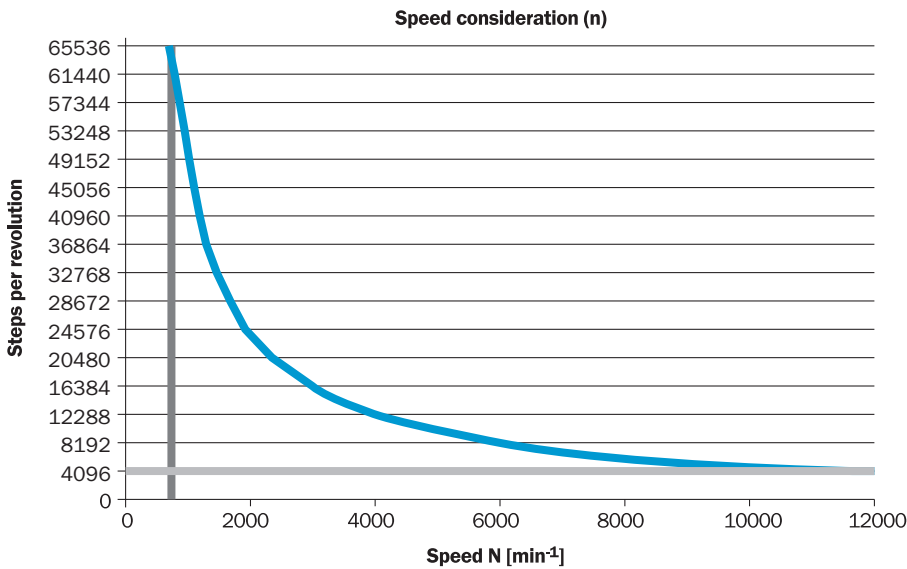

Diagrams Electrical zero pulse width can be configured to 90°, 180°, or 270°. Width of the zero pulse in relation to a pulse period.

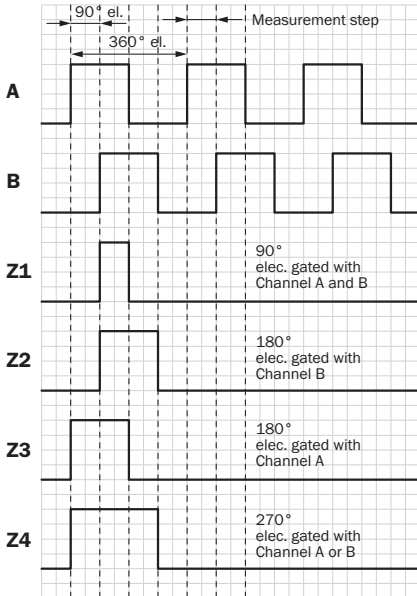

Cw with view on the encoder shaft in direction "A", compare dimensional drawing.

Supply voltage	Output
4,5 V ... 32 V	TTL/HTL programmable

Diagrams Mechanical zero pulse width 1° to 359° programmable. Width of the zero pulse in relation to a mechanical revolution of the shaft.

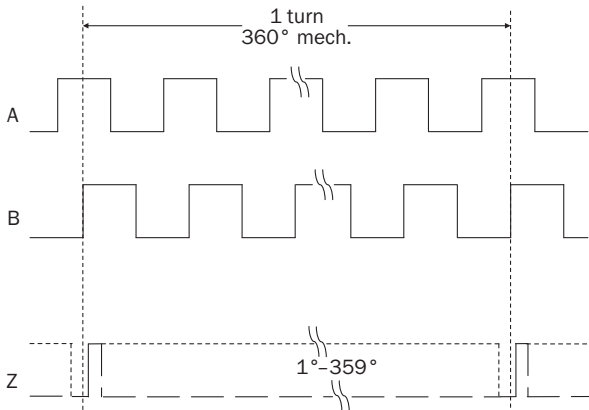







Supply voltage	Output
4,5 V ... 32 V	TTL/HTL programmable

### Recommended accessories

Other models and accessories → [www.sick.com/DFS60](http://www.sick.com/DFS60)

	Brief description	Type	part no.
Mounting systems			
	<ul style="list-style-type: none"> <li><b>Product family:</b> Stator couplings</li> <li><b>Description:</b> Standard stator coupling</li> </ul>	BEF-DS00XFX	2056812
	<ul style="list-style-type: none"> <li><b>Description:</b> Clamping ring for metal hollow shaft</li> <li><b>Material:</b> Steel</li> <li><b>Details:</b> Metal</li> </ul>	BEF-KR-M	2064709
programming devices			
	<ul style="list-style-type: none"> <li><b>Product segment:</b> Programming devices</li> <li><b>Product:</b> PGT-10 Pro</li> <li><b>Description:</b> Programming unit display for programmable SICK DFS60, DFV60, AFS/AFM60, AHS/AHM36 encoders, and wire draw encoder with DFS60, AFS/AFM60 and AHS/AHM36. Compact dimensions, low weight, and intuitive operation.</li> <li><b>Items supplied:</b> 1 x PGT-10-Pro stand-alone programming tool, 4 x alkaline type batteries, 1.5 V Mignon (AA)</li> </ul>	PGT-10-Pro	1072254
	<ul style="list-style-type: none"> <li><b>Product segment:</b> Programming devices</li> <li><b>Product:</b> PGT-08-S</li> <li><b>Description:</b> USB programming unit, for programmable SICK encoders AFS60, AFM60, DFS60, VFS60, DFV60 and wire draw encoders with programmable encoders. Not compatible with the portable SOPAS ET versions.</li> </ul>	PGT-08-S	1036616

	Brief description	Type	part no.
connectors and cables			
	<ul style="list-style-type: none"> <li>• <b>Connection type head A:</b> Female connector, M12, 8-pin, straight</li> <li>• <b>Connection type head B:</b> Male connector, D-Sub, 9-pin, straight</li> <li>• <b>Signal type:</b> Incremental</li> <li>• <b>Cable:</b> 0,5 m, 8-wire</li> <li>• <b>Description:</b> Incremental, shielded</li> <li>• <b>Note:</b> Programming adapter cable for programming tool PGT-10-Pro and PGT-08-S</li> </ul>	DSL-2D08-G0M5AC3	2046579
	<ul style="list-style-type: none"> <li>• <b>Description:</b> Incremental, shielded, SSI</li> <li>• <b>Connection type head A:</b> Female connector, M12, 8-pin, straight</li> <li>• <b>Connection type head B:</b> Flying leads</li> <li>• <b>Signal type:</b> Incremental, SSI</li> <li>• <b>Cable:</b> 2 m, 8-wire, PUR, halogen-free</li> <li>• <b>Connection systems:</b> Flying leads</li> <li>• <b>Application:</b> Drag chain operation, Zones with oils and lubricants</li> </ul>	DOL-1208-G02MAC1	6032866
	<ul style="list-style-type: none"> <li>• <b>Description:</b> Incremental, shielded, SSI</li> <li>• <b>Connection type head A:</b> Female connector, M12, 8-pin, straight</li> <li>• <b>Connection type head B:</b> Flying leads</li> <li>• <b>Signal type:</b> Incremental, SSI</li> <li>• <b>Cable:</b> 5 m, 8-wire, PUR, halogen-free</li> <li>• <b>Connection systems:</b> Flying leads</li> <li>• <b>Application:</b> Drag chain operation, Zones with oils and lubricants</li> </ul>	DOL-1208-G05MAC1	6032867
	<ul style="list-style-type: none"> <li>• <b>Description:</b> Incremental, shielded, SSI</li> <li>• <b>Connection type head A:</b> Female connector, M12, 8-pin, straight</li> <li>• <b>Connection type head B:</b> Flying leads</li> <li>• <b>Signal type:</b> Incremental, SSI</li> <li>• <b>Cable:</b> 10 m, 8-wire, PUR, halogen-free</li> <li>• <b>Connection systems:</b> Flying leads</li> <li>• <b>Application:</b> Drag chain operation, Zones with oils and lubricants</li> </ul>	DOL-1208-G10MAC1	6032868
	<ul style="list-style-type: none"> <li>• <b>Description:</b> Incremental, shielded, SSI</li> <li>• <b>Connection type head A:</b> Female connector, M12, 8-pin, straight</li> <li>• <b>Connection type head B:</b> Flying leads</li> <li>• <b>Signal type:</b> Incremental, SSI</li> <li>• <b>Cable:</b> 20 m, 8-wire, PUR, halogen-free</li> <li>• <b>Connection systems:</b> Flying leads</li> <li>• <b>Application:</b> Drag chain operation, Zones with oils and lubricants</li> </ul>	DOL-1208-G20MAC1	6032869
	<ul style="list-style-type: none"> <li>• <b>Description:</b> Incremental, shielded, SSI</li> <li>• <b>Connection type head A:</b> Female connector, M12, 8-pin, straight, A-coded</li> <li>• <b>Signal type:</b> Incremental, SSI</li> <li>• <b>Cable:</b> CAT5, CAT5e</li> <li>• <b>Connection systems:</b> IDC quick connection</li> <li>• <b>Permitted cross-section:</b> 0.14 mm<sup>2</sup> ... 0.34 mm<sup>2</sup></li> </ul>	DOS-1208-GA01	6045001
	<ul style="list-style-type: none"> <li>• <b>Description:</b> HIPERFACE<sup>®</sup>, shielded, Incremental</li> <li>• <b>Connection type head A:</b> Female connector, M12, 8-pin, angled</li> <li>• <b>Connection type head B:</b> Flying leads</li> <li>• <b>Signal type:</b> HIPERFACE<sup>®</sup>, Incremental</li> <li>• <b>Cable:</b> 2 m, 8-wire, PUR, halogen-free</li> <li>• <b>Application:</b> Zones with oils and lubricants</li> </ul>	DOL-1208-W02MAC1	6037724
	<ul style="list-style-type: none"> <li>• <b>Description:</b> HIPERFACE<sup>®</sup>, shielded, Incremental</li> <li>• <b>Connection type head A:</b> Female connector, M12, 8-pin, angled</li> <li>• <b>Connection type head B:</b> Flying leads</li> <li>• <b>Signal type:</b> HIPERFACE<sup>®</sup>, Incremental</li> <li>• <b>Cable:</b> 5 m, 8-wire, PUR, halogen-free</li> <li>• <b>Application:</b> Zones with oils and lubricants</li> </ul>	DOL-1208-W05MAC1	6037725
	<ul style="list-style-type: none"> <li>• <b>Description:</b> HIPERFACE<sup>®</sup>, shielded, Incremental</li> <li>• <b>Connection type head A:</b> Female connector, M12, 8-pin, angled</li> <li>• <b>Connection type head B:</b> Flying leads</li> <li>• <b>Signal type:</b> HIPERFACE<sup>®</sup>, Incremental</li> <li>• <b>Cable:</b> 10 m, 8-wire, PUR, halogen-free</li> <li>• <b>Application:</b> Zones with oils and lubricants</li> </ul>	DOL-1208-W10MAC1	6037726
	<ul style="list-style-type: none"> <li>• <b>Description:</b> HIPERFACE<sup>®</sup>, shielded, Incremental</li> <li>• <b>Connection type head A:</b> Female connector, M12, 8-pin, angled</li> <li>• <b>Connection type head B:</b> Flying leads</li> <li>• <b>Signal type:</b> HIPERFACE<sup>®</sup>, Incremental</li> <li>• <b>Cable:</b> 20 m, 8-wire, PUR</li> </ul>	DOL-1208-W20MAC1	6037727

	Brief description	Type	part no.
	<ul style="list-style-type: none"> <li>• <b>Application:</b> Zones with oils and lubricants</li> <li>• <b>Connection type head A:</b> Female connector, M12, 8-pin, angled</li> <li>• <b>Connection type head B:</b> Flying leads</li> <li>• <b>Cable:</b> 2 m, 8-wire, PVC</li> <li>• <b>Description:</b> Shielded</li> <li>• <b>Connection systems:</b> Flying leads</li> </ul>	DOL-1208-W02MA	6020992
	<ul style="list-style-type: none"> <li>• <b>Description:</b> Sensor/actuator cable, shielded</li> <li>• <b>Connection type head A:</b> Female connector, M12, 8-pin, angled</li> <li>• <b>Connection type head B:</b> Flying leads</li> <li>• <b>Signal type:</b> Sensor/actuator cable</li> <li>• <b>Cable:</b> 2 m, 8-wire, PUR, halogen-free</li> <li>• <b>Connection systems:</b> Flying leads</li> </ul>	DOL-1208-W02MAS01	6029224
	<ul style="list-style-type: none"> <li>• <b>Connection type head A:</b> Female connector, M12, 8-pin, angled</li> <li>• <b>Connection type head B:</b> Flying leads</li> <li>• <b>Cable:</b> 2 m, 8-wire, PUR, halogen-free</li> <li>• <b>Description:</b> Unshielded</li> </ul>	DOL-1208-W02MC	6035623
	<ul style="list-style-type: none"> <li>• <b>Connection type head A:</b> Female connector, M12, 8-pin, angled</li> <li>• <b>Connection type head B:</b> Flying leads</li> <li>• <b>Cable:</b> 5 m, 8-wire, PVC</li> <li>• <b>Description:</b> Shielded</li> <li>• <b>Connection systems:</b> Flying leads</li> </ul>	DOL-1208-W05MA	6021033
	<ul style="list-style-type: none"> <li>• <b>Connection type head A:</b> Female connector, M12, 8-pin, angled</li> <li>• <b>Connection type head B:</b> Flying leads</li> <li>• <b>Cable:</b> 5 m, 8-wire, PUR</li> <li>• <b>Description:</b> Unshielded</li> </ul>	DOL-1208-W05MC	6035624
	<ul style="list-style-type: none"> <li>• <b>Connection type head A:</b> Female connector, M12, 8-pin, angled</li> <li>• <b>Connection type head B:</b> Flying leads</li> <li>• <b>Cable:</b> 10 m, 8-wire, PUR, halogen-free</li> <li>• <b>Description:</b> Unshielded</li> </ul>	DOL-1208-W10MC	6035625

## SICK AT A GLANCE

SICK is one of the leading manufacturers of intelligent sensors and sensor solutions for industrial applications. A unique range of products and services creates the perfect basis for controlling processes securely and efficiently, protecting individuals from accidents and preventing damage to the environment.

We have extensive experience in a wide range of industries and understand their processes and requirements. With intelligent sensors, we can deliver exactly what our customers need. In application centers in Europe, Asia and North America, system solutions are tested and optimized in accordance with customer specifications. All this makes us a reliable supplier and development partner.

Comprehensive services complete our offering: SICK LifeTime Services provide support throughout the machine life cycle and ensure safety and productivity.

For us, that is “Sensor Intelligence.”

## WORLDWIDE PRESENCE:

Contacts and other locations –[www.sick.com](http://www.sick.com)