



S30B-3011BA

S300

SAFETY LASER SCANNERS

SICK
Sensor Intelligence.



Illustration may differ



Ordering information

Type	part no.
S30B-3011BA	1056427

Other models and accessories → www.sick.com/S300

Detailed technical data

Features

Product version	S300 Standard
Model	Sensor without system plug
Application	Indoor
Protective field range	3 m
Warning field range	8 m (at 15 % reflectivity)
Distance measuring range	30 m
Type of field set	Triple field sets
Number of field sets	1
Number of fields	3
Number of monitoring cases	1
Scanning angle	270°
Resolution (can be configured)	30 mm, 40 mm, 50 mm, 70 mm, 150 mm
Angular resolution	0.5°
Response time	80 ms ¹⁾
Protective field supplement	100 mm
Number of multiple samplings	2 ... 16, configurable
Delay of automatic reset	2 s ... 60 s, configurable

¹⁾ Depending on basic response time and multiple sampling.

Safety-related parameters

Type	Type 3 (IEC 61496)
Safety integrity level	SIL 2 (IEC 61508)

Category	Category 3 (EN ISO 13849)
Performance level	PL d (EN ISO 13849)
PFH_D (mean probability of a dangerous failure per hour)	8,0 x 10 ⁻⁸
T_M (mission time)	20 years (EN ISO 13849)
Safe state in the event of a fault	At least one OSSD is in the OFF state.

Functions

Restart interlock	✓
External device monitoring (EDM)	✓
Multiple sampling	✓
Contour as a reference	✓
Integrated configuration memory	✓
Measured data output	Via RS-422
Safe SICK device communication via EFI	✓

Interfaces

Connection type	System plug with or without connecting cable
Universal I/Os	5 ¹⁾
Inputs	
External device monitoring (EDM)	1 ²⁾
Reset/restart	1 ²⁾
Standby	1
Outputs	
OSSD pairs	1
Application diagnostic outputs	3 ³⁾
Configuration method	PC with CDS (Configuration and Diagnostic Software)
Configuration and diagnostics interface	RS-232
Transmission rate	38.4 kBaud
Data interface	RS-422
Transmission rate	≤ 500 kBaud
Safe SICK device communication via EFI	
Transmission rate	≤ 500 kBaud
Length of cable	≤ 50 m
Conductor cross section	0.22 mm ²

¹⁾ Freely programmable, e.g., external device monitoring input, reset input, contamination warning, reset required.

²⁾ Availability depends on the configuration of the universal I/Os.

³⁾ Freely programmable, e.g. warning field, contamination, reset required.

Electronics

Protection class	III (EN 50178, EN 60950)
-------------------------	--------------------------

¹⁾ At 24 V DC without output load.

²⁾ At 24 V DC including maximum output load.

³⁾ Freely programmable, e.g. warning field, contamination, reset required.

Supply voltage V_s	24 V DC (16.8 V DC ... 30 V DC)
Power consumption	0.33 A ¹⁾ 1.7 A ²⁾
Outputs	
Output signal switching devices (OSSDs)	2 x 250 mA
Application diagnostic outputs	3 x 100 mA ³⁾

¹⁾ At 24 V DC without output load.

²⁾ At 24 V DC including maximum output load.

³⁾ Freely programmable, e.g. warning field, contamination, reset required.

Mechanics

Dimensions (W x H x D)	102 mm x 152 mm x 106 mm
Weight	1.2 kg
Housing material	Aluminum die cast
Housing color	RAL 1021 (yellow)
Optics cover material	Polycarbonate
Optics cover surface finish	Outside with scratch-resistant coating

Ambient data

Enclosure rating	IP65 (EN 60529)
Ambient operating temperature	-10 °C ... +50 °C
Storage temperature	-25 °C ... +50 °C
Vibration resistance	IEC 60068-2-6, IEC 60068-2-64, IEC 60721-3-5, IEC TR 60721-4-5, IEC 61496-3
Class	5M1 (IEC 60721-3-5)
Shock resistance	IEC 60068-2-27, IEC 60721-3-5, IEC TR 60721-4-5, IEC 61496-3
Class	5M1 (IEC 60721-3-5)
Continuous shock	50 m/s ² , 11 ms 100 m/s ² , 16 ms

Other information

Type of light	Pulsed laser diode
Wave length	905 nm
Detectable remission factor	1.8 % ... > 1,000 %, reflectors
Laser class	1 (21 CFR 1040.10 and 1040.11, IEC 60825-1)

Certificates

EU declaration of conformity	✓
UK declaration of conformity	✓
ACMA declaration of conformity	✓
China RoHS	✓
cULus certificate	✓
EC-Type-Examination approval	✓
China GB certificate	✓
Information according to Art. 3 of Data Act (Regulation EU 2023/2854)	✓

Classifications

ECLASS 5.0	27272705
ECLASS 5.1.4	27272705
ECLASS 6.0	27272705
ECLASS 6.2	27272705
ECLASS 7.0	27272705
ECLASS 8.0	27272705
ECLASS 8.1	27272705
ECLASS 9.0	27272705
ECLASS 10.0	27272705
ECLASS 11.0	27272705
ECLASS 12.0	27272705
ETIM 5.0	EC002550
ETIM 6.0	EC002550
ETIM 7.0	EC002550
ETIM 8.0	EC002550
UNSPSC 16.0901	39121528

Dimensional drawing Scan plane origin

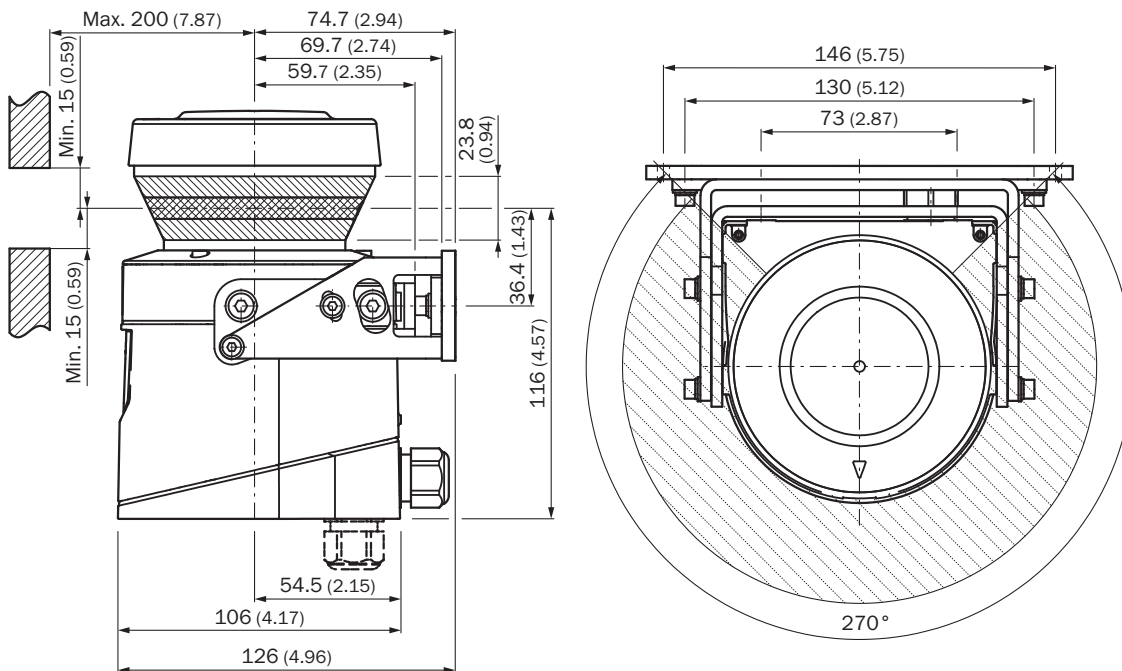

Dimensions in mm (inch)



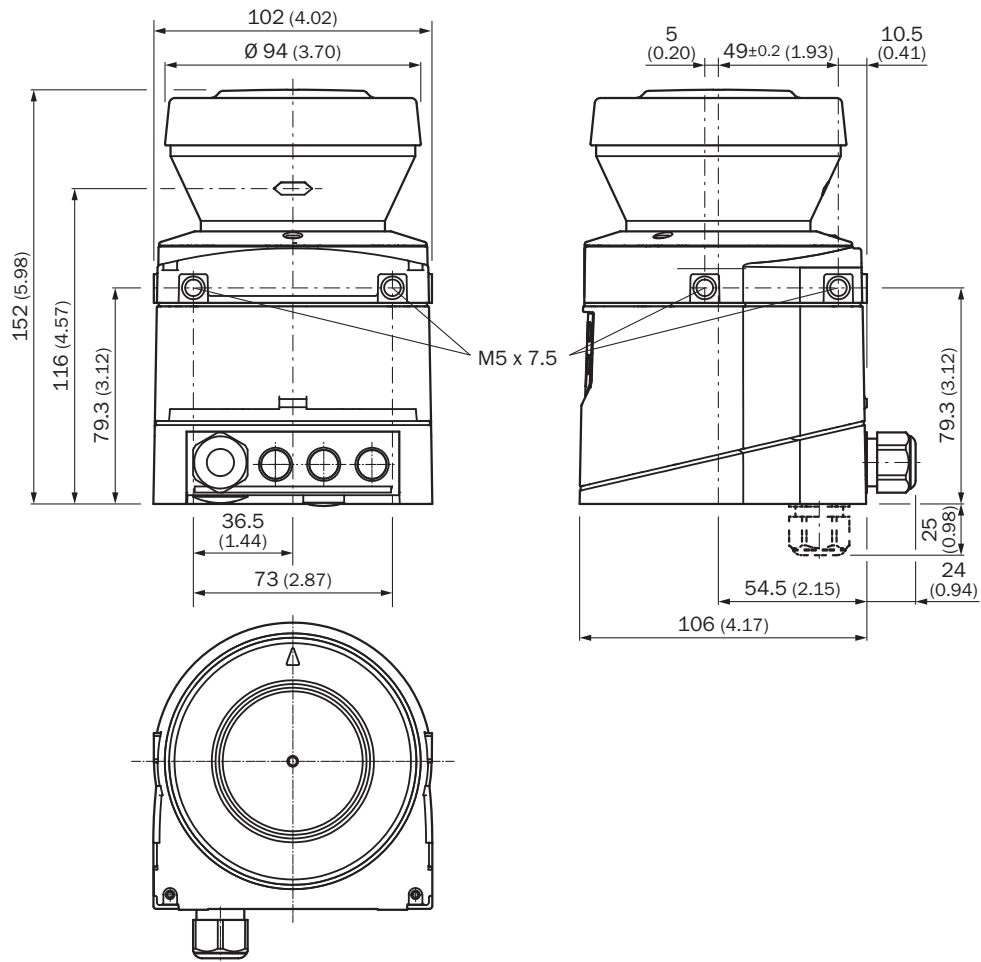





Dimensional drawing Laser scanner







Dimensions in mm (inch)

Recommended accessories

Other models and accessories → www.sick.com/S300

	Brief description	Type	part no.
Mounting systems			
	<ul style="list-style-type: none"> Description: Mounting bracket for rear mounting on wall or machine Material: Anodized aluminum Details: AlMg3, black anodized Packing unit: 1 piece Items supplied: Mounting bracket, 4 x M5 x 10 countersunk screws 	Mounting kit 1a	2034324
	<ul style="list-style-type: none"> Description: Mounting bracket for rear mounting on wall or machine with protection of optics hood Material: Anodized aluminum Details: AlMg3, black anodized Packing unit: 1 piece Items supplied: Mounting bracket, 4 x M5 x 10 countersunk screws 	Mounting kit 1b	2034325
	<ul style="list-style-type: none"> Description: Mounting bracket, adjustable lateral axis, only in conjunction with mounting kit 1a (2034324) or 1b (2034325) Material: Anodized aluminum Details: AlMg3, black anodized Packing unit: 1 piece Items supplied: Mounting bracket, 4 x countersunk screws with washers M4 x 10, 4 x spring washer 	Mounting kit 2	2039302
	<ul style="list-style-type: none"> Description: Mounting plate, adjustable longitudinal axis, only in conjunction with mounting kit 2 (2039302) Material: Anodized aluminum Details: AlMg3, black anodized Packing unit: 1 piece Items supplied: Mounting plate, 2 x countersunk screws with washers M4 x 10, 2 x spring washer 	Mounting kit 3	2039303
connectors and cables			
	<ul style="list-style-type: none"> Connection type head A: Male connector, M8, 4-pin, straight Connection type head B: Male connector, USB-A, straight Cable: 2 m, 4-wire, PVC Description: Unshielded 	DSL-8U04G02M025KM:	6034574
	<ul style="list-style-type: none"> Connection type head A: Male connector, M8, 4-pin, straight Connection type head B: Male connector, USB-A, straight Cable: 10 m, 4-wire, PVC Description: Unshielded 	DSL-8U04G10M025KM:	6034575
	<ul style="list-style-type: none"> Connection type head A: Flying leads Connection type head B: Flying leads Items supplied: By the meter Cable: 15-wire, AWG20, PVC Description: Unshielded Note: On 100 m reel 	Connecting cable	6030795
	<ul style="list-style-type: none"> Connection type head A: Flying leads Connection type head B: Flying leads Items supplied: By the meter Cable: 2-wire, twisted pair, 120 Ohm, PVC Description: Shielded Note: Fitting for EFI connections 	EFI connecting cable	6029448

	Brief description	Type	part no.
system plugs and extension modules			
	<ul style="list-style-type: none"> Description: Without cable, Not for use of incremental encoders, integrated configuration storage 	SX0B-A0000G	2032807
	<ul style="list-style-type: none"> Cable: 14 m, 11-wire, PVC Description: Pre-assembled, unshielded, Not for use of incremental encoders, integrated configuration storage Connection systems: Flying leads 	SX0B-B1114G	2047875
	<ul style="list-style-type: none"> Cable: 5 m, 11-wire, PVC Description: Pre-assembled, unshielded, Not for use of incremental encoders, integrated configuration storage Connection systems: Flying leads 	SX0B-B1105G	2032859
	<ul style="list-style-type: none"> Cable: 10 m, 11-wire, PVC Description: Pre-assembled, unshielded, Not for use of incremental encoders, integrated configuration storage Connection systems: Flying leads 	SX0B-B1110G	2032860
	<ul style="list-style-type: none"> Cable: 20 m, 11-wire, PVC Description: Pre-assembled, unshielded, Not for use of incremental encoders, integrated configuration storage Connection systems: Flying leads 	SX0B-B1120G	2032861

SICK AT A GLANCE

SICK is one of the leading manufacturers of intelligent sensors and sensor solutions for industrial applications. A unique range of products and services creates the perfect basis for controlling processes securely and efficiently, protecting individuals from accidents and preventing damage to the environment.

We have extensive experience in a wide range of industries and understand their processes and requirements. With intelligent sensors, we can deliver exactly what our customers need. In application centers in Europe, Asia and North America, system solutions are tested and optimized in accordance with customer specifications. All this makes us a reliable supplier and development partner.

Comprehensive services complete our offering: SICK LifeTime Services provide support throughout the machine life cycle and ensure safety and productivity.

For us, that is “Sensor Intelligence.”

WORLDWIDE PRESENCE:

Contacts and other locations –www.sick.com