



WSE4S-3P1330V

W4

PHOTOELECTRIC SENSORS

SICK
Sensor Intelligence.



Illustration may differ



Ordering information

Type	part no.
WSE4S-3P1330V	1052887

Other models and accessories → www.sick.com/W4

Detailed technical data

Features

Functional principle	Through-beam photoelectric sensor
Sensing range max.	0 m ... 5 m
Sensing range	0 m ... 4.5 m
Emitted beam	
Light source	PinPoint LED ¹⁾
Type of light	Visible red light
Light spot size (distance)	Ø 50 mm (2 m)
Key LED figures	
Wave length	650 nm
Adjustment	None
Special applications	Hygienic and washdown zones
Part number of individual components	2058460 WS4S-3D1330V 2058739 WE4S-3P1330V
Housing design	Washdown

¹⁾ Average service life: 100,000 h at T_J = +25 °C.

Safety-related parameters

MTTF_D	968 years
DC_{avg}	0 %
T_M (mission time)	20 years

Electronics

Supply voltage U_B	10 V DC ... 30 V DC ¹⁾
Ripple	< 5 V _{pp} ²⁾
Protection class	III
Digital output	
Type	PNP
Switching mode	Light switching
Output current I_{max}	≤ 100 mA
Response time	< 0.5 ms ³⁾
Switching frequency	1,000 Hz ⁴⁾
Circuit protection	A ⁵⁾ B ⁶⁾ C ⁷⁾
Test input sender off	TE to 0 V

¹⁾ Limit values, reverse-polarity protected, operation in short-circuit protected network: max. 8 A.

²⁾ May not fall below or exceed U_V tolerances.

³⁾ Signal transit time with resistive load.

⁴⁾ With light/dark ratio 1:1.

⁵⁾ A = V_S connections reverse-polarity protected.

⁶⁾ B = inputs and output reverse-polarity protected.

⁷⁾ C = interference suppression.

Mechanics

Housing	Rectangular
Design detail	Slim
Dimensions (W x H x D)	15.25 mm x 48.6 mm x 22.2 mm
Connection	Cable, 3-wire, 2 m ¹⁾
Connection detail	
Conductor size	0.14 mm ²
Length of cable (L)	2 m ¹⁾
Material	
Housing	Metal, Stainless steel V4A (1.4404, 316L)
Front screen	Plastic, PMMA
Cable	Plastic, PVC
Weight	80 g

¹⁾ Do not bend below 0 °C.

Ambient data

Enclosure rating	IP66 IP67 IP68 IP69K
Ambient operating temperature	-30 °C ... +70 °C ¹⁾
Ambient temperature, storage	-30 °C ... +75 °C

¹⁾ At $U_V \leq 24$ V and $I_A < 30$ mA.

UL File No.	NRKH.E181493 & NRKH7.E181493
--------------------	------------------------------

¹⁾ At UV ≤ 24 V and IA < 30 mA.

Certificates

EU declaration of conformity	✓
UK declaration of conformity	✓
ACMA declaration of conformity	✓
Moroccan declaration of conformity	✓
China RoHS	✓
ECOLAB certificate	✓
Photobiological safety (DIN EN 62471) certificate	✓

Classifications

ECLASS 5.0	27270901
ECLASS 5.1.4	27270901
ECLASS 6.0	27270901
ECLASS 6.2	27270901
ECLASS 7.0	27270901
ECLASS 8.0	27270901
ECLASS 8.1	27270901
ECLASS 9.0	27270901
ECLASS 10.0	27270901
ECLASS 11.0	27270901
ECLASS 12.0	27270901
ETIM 5.0	EC002716
ETIM 6.0	EC002716
ETIM 7.0	EC002716
ETIM 8.0	EC002716
UNSPSC 16.0901	39121528

Connection diagram Cd-061

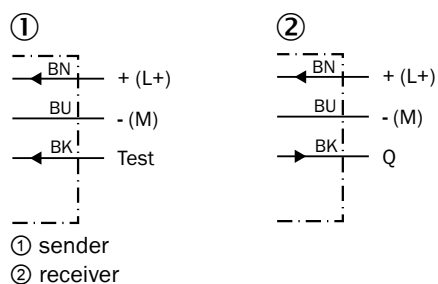

Characteristic curve WSE4S-3V, WSE4S-3H

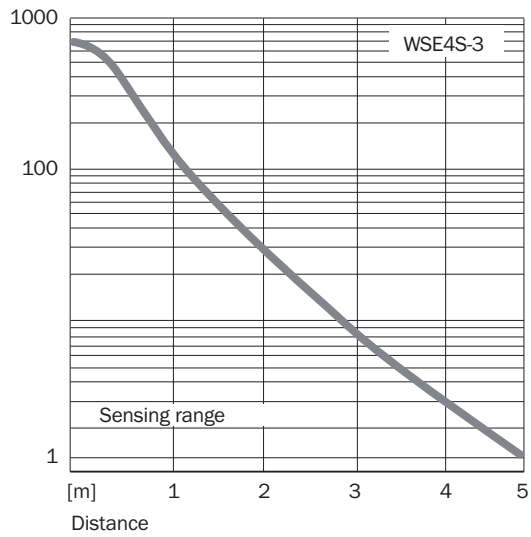

Sensing range diagram WSE4S-3

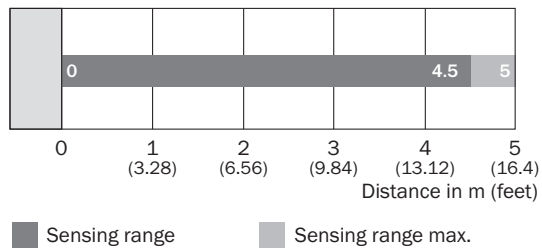

Dimensional drawing WL4S-3V, WLG4S-3V, without single teach-in button

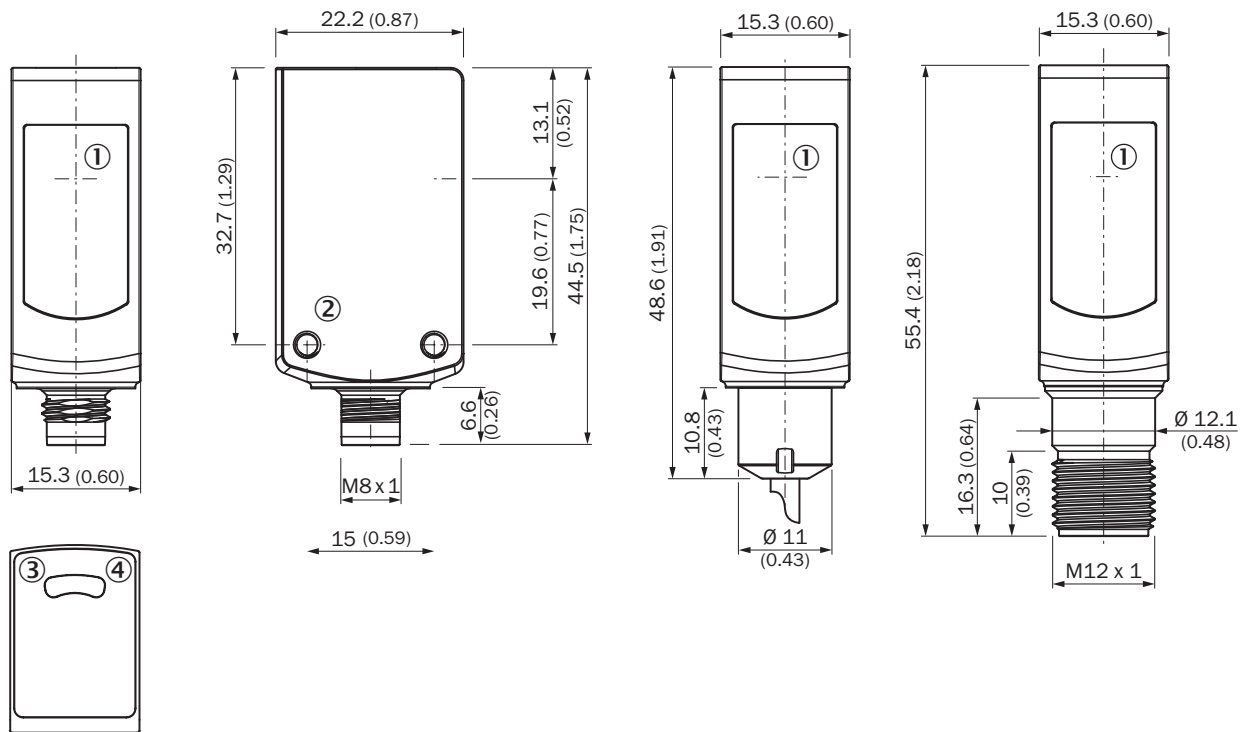



Dimensions in mm (inch)

- ① Center of optical axis
- ② Threaded mounting hole M8
- ③ LED indicator yellow: Status of received light beam
- ④ LED indicator green: Supply voltage active

Recommended accessories

Other models and accessories → www.sick.com/W4

	Brief description	Type	part no.
connectors and cables			
	<ul style="list-style-type: none"> • Description: Unshielded • Connection type head A: Male connector, M8, 3-pin, straight, A-coded • Connection systems: Screw-type terminals • Permitted cross-section: 0.14 mm² ... 0.5 mm² 	STE-0803-G	6037322

	Brief description	Type	part no.
Mounting systems			
	<ul style="list-style-type: none"> • Description: Mounting bracket for floor mounting • Material: Stainless steel • Details: Stainless steel 1.4571 • Items supplied: Mounting hardware included • Suitable for: W4S, W4F, W4S 	BEF-W4-B	2051630
	<ul style="list-style-type: none"> • Description: Plate N02N for universal clamp bracket • Material: Stainless steel, stainless steel • Details: Stainless steel 1.4571 (sheet), Stainless steel 1.4408 (clamp) • Items supplied: Universal clamp (5322627), mounting hardware • Usable for: W4S-3 Glass, W10, W4SLG-3, W4S-3 Inox, W4S-3 Inox Glass, W9, W11-2, W12-3, W12-2 Laser, W12G, W12 Teflon, W16, W250, W250-2, PowerProx, W11G-2, TranspaTect, WTT12, UC12, P250, G6 Inox, W4S, W4SL-3V, W4SLG-3V, W4SL-3H 	BEF-KHS-N02N	2051618

SICK AT A GLANCE

SICK is one of the leading manufacturers of intelligent sensors and sensor solutions for industrial applications. A unique range of products and services creates the perfect basis for controlling processes securely and efficiently, protecting individuals from accidents and preventing damage to the environment.

We have extensive experience in a wide range of industries and understand their processes and requirements. With intelligent sensors, we can deliver exactly what our customers need. In application centers in Europe, Asia and North America, system solutions are tested and optimized in accordance with customer specifications. All this makes us a reliable supplier and development partner.

Comprehensive services complete our offering: SICK LifeTime Services provide support throughout the machine life cycle and ensure safety and productivity.

For us, that is “Sensor Intelligence.”

WORLDWIDE PRESENCE:

Contacts and other locations –www.sick.com