



OLM100-1005S01

OLM

OPTICAL LINEAR MEASUREMENT SENSORS

**SICK**  
Sensor Intelligence.



Illustration may differ



### Ordering information

Type	part no.
OLM100-1005S01	1050976

Other models and accessories → [www.sick.com/OLM](http://www.sick.com/OLM)

### Detailed technical data

#### Safety-related parameters

<b>MTTF<sub>D</sub> (mean time to dangerous failure)</b>	> 100 years
<b>DC<sub>avg</sub> (average diagnostic coverage)</b>	0 %

#### Features

<b>Measuring range</b>	0 m ... 10,000 m <sup>1)</sup>
<b>Resolution</b>	1 mm
<b>Repeatability</b>	1 mm <sup>2)</sup>
<b>Output time</b>	5 ms
<b>Light source</b>	LED, red
<b>Max. movement speed</b>	4 m/s
<b>Reading distance</b>	100 mm, ± 20 mm
<b>Barcode width</b>	30 mm

<sup>1)</sup> Dependent on the set resolution and transfer protocol.

<sup>2)</sup> Statistical error 1  $\sigma$ .

#### Interfaces

<b>Serial</b>	✓, RS-485
---------------	-----------

#### Electronics

<b>Supply voltage V<sub>s</sub></b>	DC 10 V ... 30 V <sup>1)</sup>
<b>Ripple</b>	≤ 5 V <sub>pp</sub> <sup>2)</sup>
<b>Power consumption</b>	< 3 W
<b>Initialization time</b>	< 3 s
<b>Enclosure rating</b>	IP65

<sup>1)</sup> Limit values, reverse-polarity protected.

<sup>2)</sup> May not fall below or exceed U<sub>v</sub> tolerances.

<b>Protection class</b>	III
-------------------------	-----

- 1) Limit values, reverse-polarity protected.
- 2) May not fall below or exceed  $U_y$  tolerances.

Ambient data

<b>Electromagnetic compatibility (EMC)</b>	EN 61000-6-2 / EN 61000-6-4
<b>Ambient temperature, operation</b>	-30 °C ... +60 °C <sup>1)</sup>
<b>Ambient temperature, storage</b>	-40 °C ... +75 °C <sup>2)</sup>
<b>Typ. Ambient light immunity</b>	≤ 9,000 lx <sup>3)</sup>
<b>Vibration resistance</b>	DIN/EN 60068-2-6, DIN/EN 60068-2-64
<b>Shock resistance</b>	DIN/EN 60068-2-27

- 1) Temperatures < -20 °C with 5 min warm-up time.
- 2) Max. 95 % humidity, non-condensing.
- 3) Typ. value at +25 °C ambient temperature.

Certificates

<b>EU declaration of conformity</b>	✓
<b>UK declaration of conformity</b>	✓
<b>ACMA declaration of conformity</b>	✓
<b>Moroccan declaration of conformity</b>	✓
<b>China RoHS</b>	✓
<b>cULus certificate</b>	✓
<b>Information according to Art. 3 of Data Act (Regulation EU 2023/2854)</b>	✓

Dimensional drawing

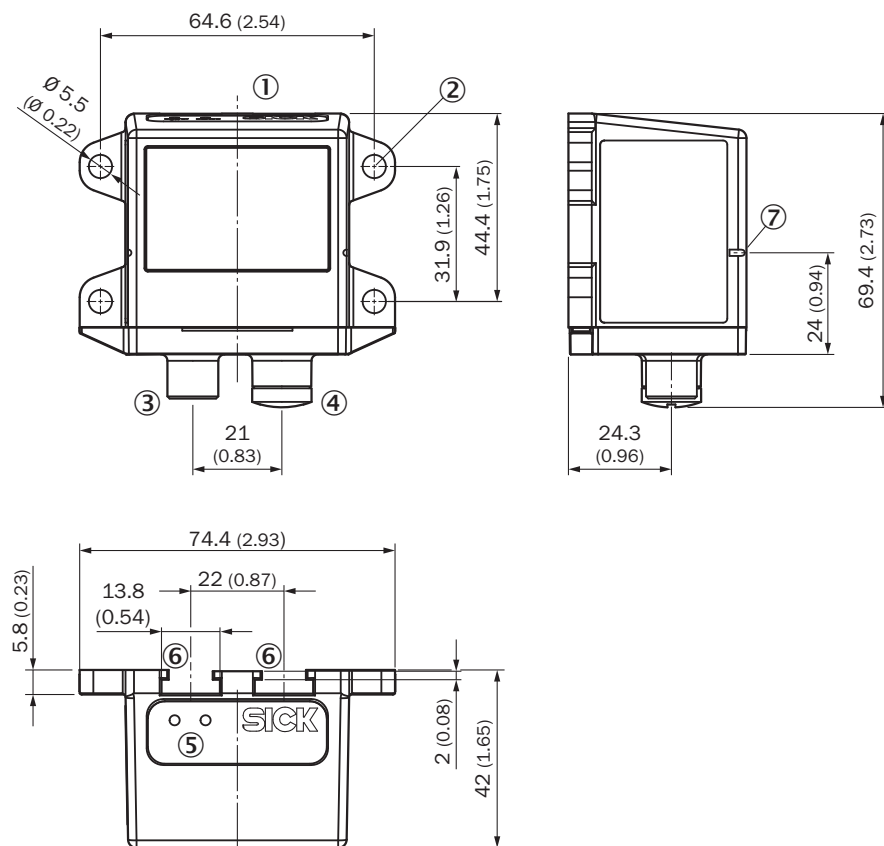

Dimensions in mm (inch)

- ① Reference axis position measurement
- ② Mounting holes,  $\varnothing$  5.5 mm
- ③ M12 device connector plug, 5-pin
- ④ Ethernet M12 female connector, 4-pin
- ⑤ status LED [status]
- ⑥ T-slot
- ⑦ Adjustment aid (slot)

Pinouts OLM100-10x5

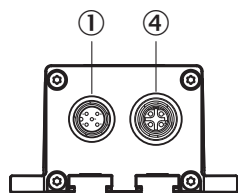

- ① M12 plug, 5-pin, RS-485 interface
- ④ M12 socket, 4-pin, Ethernet interface

Connection diagram OLM100-10x5 1 x socket M12, 4-pin 1 x connector M12, 5-pin

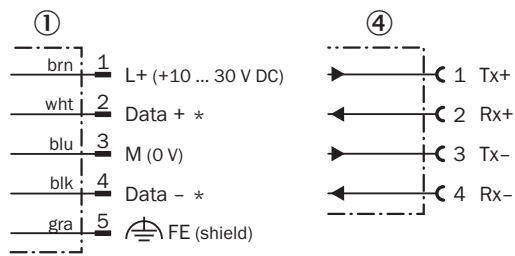

M12 (A-coded)

M12 (D-coded)

\* Termination resistors integrated in sensor













① RS-485

④ Ethernet

Recommended accessories

Other models and accessories → [www.sick.com/OLM](http://www.sick.com/OLM)

	Brief description	Type	part no.
Mounting systems			
	<ul style="list-style-type: none"> <li><b>Description:</b> Sliding nut set, M5, 4x</li> <li><b>Packing unit:</b> 4 pieces</li> <li><b>Items supplied:</b> Included in delivery</li> </ul>	Sliding nuts	2017550

	Brief description	Type	part no.
connectors and cables			
	<ul style="list-style-type: none"> <li><b>Description:</b> CANopen, shielded, DeviceNet™</li> <li><b>Connection type head A:</b> Male connector, M12, 5-pin, straight, A-coded</li> <li><b>Signal type:</b> CANopen, DeviceNet™</li> <li><b>Connection systems:</b> Screw-type terminals</li> <li><b>Permitted cross-section:</b> ≤ 0.75 mm²</li> </ul>	STE-1205-GA	6027533
	<ul style="list-style-type: none"> <li><b>Connection type head A:</b> Male connector, M12, 4-pin, angled, D-coded</li> <li><b>Connection type head B:</b> Male connector, RJ45, 8-pin, straight</li> <li><b>Signal type:</b> Ethernet</li> <li><b>Cable:</b> 2 m, 4-wire, CAT5, CAT5e, PUR, halogen-free</li> <li><b>Description:</b> Ethernet, shielded</li> </ul>	SSL-2J04-H02ME	6047911
	<ul style="list-style-type: none"> <li><b>Description:</b> Sensor/actuator cable, shielded</li> <li><b>Connection type head A:</b> Female connector, M12, 5-pin, straight, A-coded</li> <li><b>Connection type head B:</b> Flying leads</li> <li><b>Signal type:</b> Sensor/actuator cable</li> <li><b>Cable:</b> 5 m, 5-wire, PUR, halogen-free</li> <li><b>Application:</b> Drag chain operation, Zones with oils and lubricants, Robot, Drag chain operation</li> </ul>	YF2A25-050UB6XLEAX	2095733
	<ul style="list-style-type: none"> <li><b>Connection type head A:</b> Male connector, M12, 4-pin, straight, D-coded</li> <li><b>Connection type head B:</b> Male connector, RJ45, 4-pin, straight</li> <li><b>Signal type:</b> Ethernet, PROFINET</li> <li><b>Cable:</b> 2 m, 4-wire, PUR, halogen-free</li> <li><b>Description:</b> Ethernet, shielded, PROFINET</li> <li><b>Application:</b> Drag chain operation, Zones with oils and lubricants</li> </ul>	YM2D24-020P-N1MRJA4	2106182
	<ul style="list-style-type: none"> <li><b>Description:</b> Sensor/actuator cable, shielded</li> <li><b>Connection type head A:</b> Female connector, M12, 5-pin, straight, A-coded</li> <li><b>Connection type head B:</b> Flying leads</li> <li><b>Signal type:</b> Sensor/actuator cable</li> <li><b>Cable:</b> 2 m, 5-wire, PUR, halogen-free</li> <li><b>Application:</b> Drag chain operation, Zones with oils and lubricants, Robot, Drag chain operation</li> </ul>	YF2A25-020UB6XLEAX	2145583
	<ul style="list-style-type: none"> <li><b>Description:</b> Sensor/actuator cable, shielded</li> <li><b>Connection type head A:</b> Female connector, M12, 5-pin, straight, A-coded</li> <li><b>Connection type head B:</b> Flying leads</li> <li><b>Signal type:</b> Sensor/actuator cable</li> <li><b>Cable:</b> 1 m, 5-wire, PUR, halogen-free</li> <li><b>Application:</b> Drag chain operation, Zones with oils and lubricants, Robot, Drag chain operation</li> </ul>	YF2A25-010UB6XLEAX	2145582
	<ul style="list-style-type: none"> <li><b>Description:</b> Sensor/actuator cable, shielded</li> <li><b>Connection type head A:</b> Female connector, M12, 5-pin, straight, A-coded</li> <li><b>Connection type head B:</b> Flying leads</li> <li><b>Signal type:</b> Sensor/actuator cable</li> <li><b>Cable:</b> 0.6 m, 5-wire, PUR, halogen-free</li> <li><b>Application:</b> Drag chain operation, Zones with oils and lubricants, Robot, Drag chain operation</li> </ul>	YF2A25-C60UB6XLEAX	2145581
Codes			
	<ul style="list-style-type: none"> <li><b>Description:</b> 30 mm, height: 60 mm, measuring range: customer-specific</li> <li><b>Suitable for:</b> OLM100/OLM200-1x0x</li> </ul>	Customer-specific bar code tape	5327812
	<ul style="list-style-type: none"> <li><b>Description:</b> 30 mm, height: 100 mm, measuring range: customer-specific</li> <li><b>Suitable for:</b> OLM100/OLM200-1x0x</li> </ul>	Customer-specific bar code tape	5327576
	<ul style="list-style-type: none"> <li><b>Description:</b> 30 mm, height: 25 mm, measuring range: customer-specific</li> <li><b>Suitable for:</b> OLM100/OLM200-1x0x</li> </ul>	Customer-specific bar code tape	5328960
	<ul style="list-style-type: none"> <li><b>Description:</b> 30 mm, height: 40 mm, measuring range: customer-specific</li> <li><b>Suitable for:</b> OLM100/OLM200-1x0x</li> </ul>	Customer-specific bar code tape	5323951
	<ul style="list-style-type: none"> <li><b>Description:</b> 30 mm, height: 30 mm, measuring range: customer-specific</li> <li><b>Suitable for:</b> OLM100/OLM200-1x0x</li> </ul>	Customer-specific bar code tape	5322556

## SICK AT A GLANCE

SICK is one of the leading manufacturers of intelligent sensors and sensor solutions for industrial applications. A unique range of products and services creates the perfect basis for controlling processes securely and efficiently, protecting individuals from accidents and preventing damage to the environment.

We have extensive experience in a wide range of industries and understand their processes and requirements. With intelligent sensors, we can deliver exactly what our customers need. In application centers in Europe, Asia and North America, system solutions are tested and optimized in accordance with customer specifications. All this makes us a reliable supplier and development partner.

Comprehensive services complete our offering: SICK LifeTime Services provide support throughout the machine life cycle and ensure safety and productivity.

For us, that is “Sensor Intelligence.”

## WORLDWIDE PRESENCE:

Contacts and other locations –[www.sick.com](http://www.sick.com)