



VSPI-4F2111

Inspector

2D MACHINE VISION

SICK
Sensor Intelligence.



Ordering information

Type	part no.
VSPi-4F2111	1047913

Other models and accessories → www.sick.com/Inspector

Detailed technical data

Features

Technology	2D snapshot
Configurable	✓
Toolkit	Object Locator Contour Pixel Counter Edge Pixel Counter Pattern
Image sensor	CMOS monochrome
Optical focus	Adjustable focus (manual)
Working range	≥ 50 mm
Operating distance with internal illumination	50 mm ... 200 mm
Field of view of internal illumination	22 mm x 15 mm ... 79 mm x 58 mm
Illumination	Integrated
Illumination color	White
LED class	Risk group 1 (low risk, IEC62471 : 2006)
Spectral range	Approx. 400 nm ... 750 nm
Offline support	Emulator
Lens	S-mount
	Optical format 1/3"
	Focal length 10 mm
Task	Detecting - Standard objects Measuring - Dimension, contour and volume Measuring - Number Identifying - OCR Identifying - Pattern Determining position - 2D position determination

Mechanics/electronics

Supply voltage	24 V DC, ± 20 %
Ripple	< 5 V _{pp}
Current consumption	≤ < 450 mA Without output load
Enclosure rating	IP67 ¹⁾
Housing material	Aluminum
Window material	PMMA
Weight	350 g
Dimensions (L x W x H)	100 mm x 53 mm x 38 mm

¹⁾ With front window mounted.

Performance

Sensor properties	
Sensor resolution	640 px x 480 px (0.3 MP)
Scan/frame rate	40 fps ¹⁾
Number of inspections	32
Reference images	32 objects

¹⁾ Max. 250 fps.

Interfaces

EtherNet/IP™	✓
Data transmission rate	100 Mbit/s
Operator interfaces	Inspector Viewer
Configuration software	SOPAS ET
Data storage and retrieval	Log for 30 images, record images on PC, store images to FTP
Ethernet communication	EtherNet/IP™
Digital input	4 inputs (24 V)
Configurable inputs	External trigger, encoder input, External teach, reference object selection
Digital output	3 digital outputs, 24 V (B-type)
Configurable outputs	Output by logical expressions, Additional image storage possibility via FTP
Output current	≤ 100 mA
Standard outputs	No object detected, Everything OK, Detail error
Maximum encoder frequency	Max. 40 kHz
External illumination	5 V TTL
I/O box extension	5 x inputs for object selection, 16 outputs

Ambient data

Shock load	EN 60068-2-27
Vibration load	IEC 60068-2-6
Ambient operating temperature	0 °C ... +45 °C ¹⁾
Storage temperature	-20 °C ... +70 °C ¹⁾

¹⁾ Relative humidity: 35% ... 85%, 95% in storage.

Certificates

EU declaration of conformity	✓
ACMA declaration of conformity	✓
China RoHS	✓
cULus certificate	✓
Information according to Art. 3 of Data Act (Regulation EU 2023/2854)	✓

Classifications

ECLASS 5.0	27310205
ECLASS 5.1.4	27310205
ECLASS 6.0	27310205
ECLASS 6.2	27310205
ECLASS 7.0	27310205
ECLASS 8.0	27310205
ECLASS 8.1	27310205
ECLASS 9.0	27310205
ECLASS 10.0	27310205
ECLASS 11.0	27310205
ECLASS 12.0	27310205
ETIM 5.0	EC001820
ETIM 6.0	EC001820
ETIM 7.0	EC001820
ETIM 8.0	EC001820
UNSPSC 16.0901	43211731

Dimensional drawing Standard

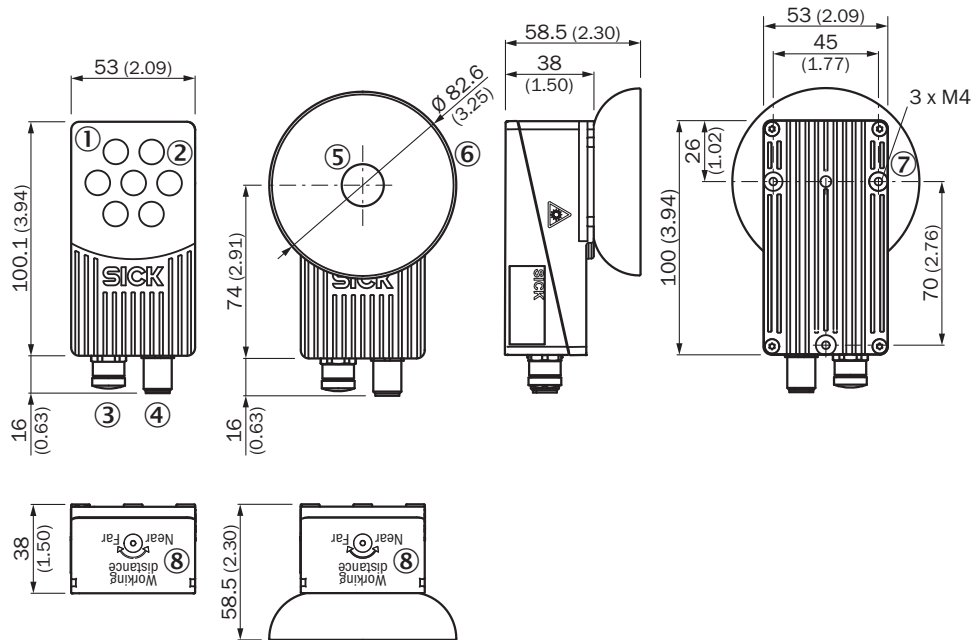

Dimensions in mm (inch)

- ① Front screen: standard, flex
- ② ring lighting
- ③ Ethernet connection M12, 4-pin, female
- ④ Power connection M12, 12-pin, male
- ⑤ Front screen: dome
- ⑥ dome light
- ⑦ Mounting hole M4
- ⑧ focus

Field of view

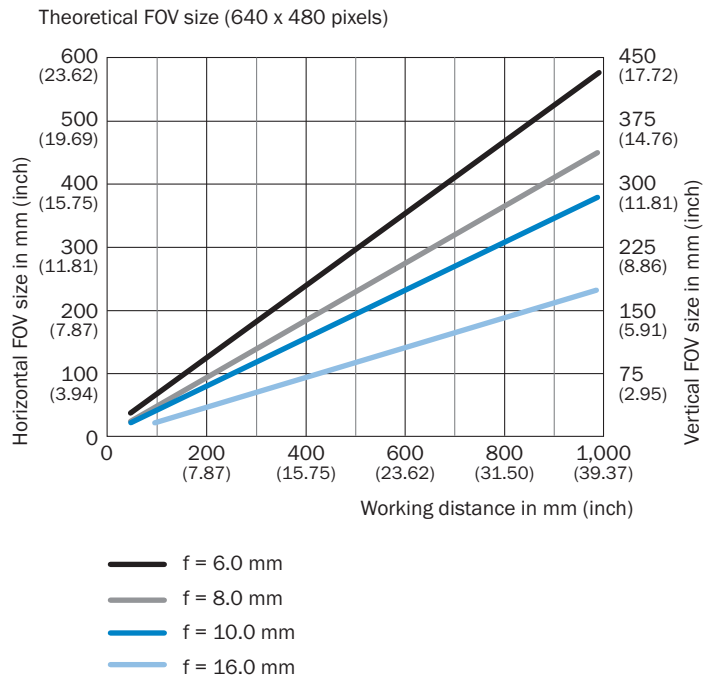

Connection type

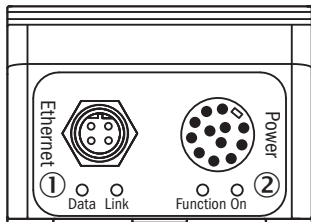

- ① Ethernet connection M12, 4-pin, female
- ② Power connection M12, 12-pin, male

Ethernet connection diagram

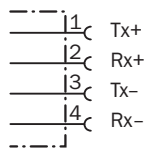



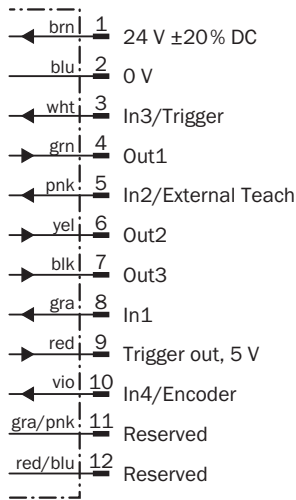





M12 connection diagram, 12-pin



Recommended accessories

Other models and accessories → www.sick.com/Inspector

	Brief description	Type	part no.
reflectors and optics			
	<ul style="list-style-type: none"> Description: Color filter blue (468 nm ± 62 nm) for variants with exchangeable lens and front window, PMMA 	Inspector Flex blue color filter	2050676
	<ul style="list-style-type: none"> Description: Color filter green (544 nm ± 53 nm) for variants with exchangeable lens and front window, PMMA 	Inspector Flex green color filter	2050677
	<ul style="list-style-type: none"> Description: Color filter red for variants with exchangeable lens and front window, PMMA 	Inspector Flex red color filter	2050675
	<ul style="list-style-type: none"> Description: Replaces the front screen and generates even and uniform illumination, for glossy surfaces 	Inspector Flex Dome	2050678
	<ul style="list-style-type: none"> Description: Exchangeable lens, focal length 6 mm 	OBJ-B06025BA	2049668
	<ul style="list-style-type: none"> Description: Exchangeable lens, focal length 16 mm, including spacer ring 	OBJ-B16018BA	2049418

	Brief description	Type	part no.
connectors and cables			
	<ul style="list-style-type: none"> • Connection type head A: Male connector, M12, 4-pin, straight, D-coded • Connection type head B: Male connector, RJ45, 4-pin, straight • Signal type: Ethernet, PROFINET • Cable: 2 m, 4-wire, PUR, halogen-free • Description: Ethernet, shielded, PROFINET • Application: Drag chain operation, Zones with oils and lubricants 	YM2D24-020P-N1MRJA4	2106182
	<ul style="list-style-type: none"> • Description: Sensor/actuator cable, shielded • Connection type head A: Female connector, M12, 12-pin, straight, A-coded • Connection type head B: Flying leads • Signal type: Sensor/actuator cable • Cable: 5 m, 12-wire, PUR, halogen-free • Application: Drag chain operation, Zones with oils and lubricants, Robot, Drag chain operation 	YF2A2B-050UD2XLEAX	2130999

SICK AT A GLANCE

SICK is one of the leading manufacturers of intelligent sensors and sensor solutions for industrial applications. A unique range of products and services creates the perfect basis for controlling processes securely and efficiently, protecting individuals from accidents and preventing damage to the environment.

We have extensive experience in a wide range of industries and understand their processes and requirements. With intelligent sensors, we can deliver exactly what our customers need. In application centers in Europe, Asia and North America, system solutions are tested and optimized in accordance with customer specifications. All this makes us a reliable supplier and development partner.

Comprehensive services complete our offering: SICK LifeTime Services provide support throughout the machine life cycle and ensure safety and productivity.

For us, that is “Sensor Intelligence.”

WORLDWIDE PRESENCE:

Contacts and other locations –www.sick.com