



WTB4S-3P2264V

W4

PHOTOELECTRIC SENSORS

**SICK**  
Sensor Intelligence.



Illustration may differ



### Ordering information

Type	part no.
WTB4S-3P2264V	1047651

Other models and accessories → [www.sick.com/W4](http://www.sick.com/W4)

### Detailed technical data

#### Features

<b>Functional principle</b>	Photoelectric proximity sensor	
<b>Functional principle detail</b>	Background suppression	
<b>Sensing range max.</b>	4 mm ... 500 mm <sup>1)</sup>	
<b>Sensing range</b>	10 mm ... 350 mm <sup>1)</sup>	
<b>Emitted beam</b>	Light source	PinPoint LED <sup>2)</sup>
	Type of light	Visible red light
	Light spot size (distance)	Ø 6.5 mm (150 mm)
<b>Key LED figures</b>	Wave length	650 nm
	<b>Adjustment</b>	Cable, Single teach-in button <sup>3)</sup>
<b>Special applications</b>	Hygienic and washdown zones	
<b>Housing design</b>	Washdown	

<sup>1)</sup> Object with 90% remission (based on standard white, DIN 5033).

<sup>2)</sup> Average service life: 100,000 h at T<sub>U</sub> = +25 °C.

<sup>3)</sup> External teach-in: pulse > 2 s with voltage U<sub>v</sub> with PNP and M with NPN.

#### Safety-related parameters

<b>MTTF<sub>D</sub></b>	1,071 years
<b>DC<sub>avg</sub></b>	0%
<b>T<sub>M</sub> (mission time)</b>	20 years

## Electronics

<b>Supply voltage <math>U_B</math></b>	10 V DC ... 30 V DC <sup>1)</sup>
<b>Ripple</b>	< 5 V <sub>pp</sub> <sup>2)</sup>
<b>Current consumption</b>	30 mA <sup>3)</sup>
<b>Protection class</b>	III
<b>Digital output</b>	
Type	PNP
Switching mode	Light switching
Output current $I_{max}$	≤ 100 mA
Response time	< 0.5 ms <sup>4)</sup>
Switching frequency	1,000 Hz <sup>5)</sup>
<b>Output function</b>	Complementary
<b>Circuit protection</b>	A <sup>6)</sup> B <sup>7)</sup> C <sup>8)</sup>

<sup>1)</sup> Limit values, reverse-polarity protected, operation in short-circuit protected network: max. 8 A.

<sup>2)</sup> May not fall below or exceed  $U_V$  tolerances.

<sup>3)</sup> Without load.

<sup>4)</sup> Signal transit time with resistive load.

<sup>5)</sup> With light/dark ratio 1:1.

<sup>6)</sup> A =  $V_S$  connections reverse-polarity protected.

<sup>7)</sup> B = inputs and output reverse-polarity protected.

<sup>8)</sup> C = interference suppression.

## Mechanics

<b>Housing</b>	Rectangular
<b>Design detail</b>	Slim
<b>Dimensions (W x H x D)</b>	15.25 mm x 44.9 mm x 22.2 mm
<b>Connection</b>	Male connector M8, 4-pin <sup>1)</sup>
<b>Material</b>	
Housing	Metal, Stainless steel V4A (1.4404, 316L)
Front screen	Plastic, PMMA
<b>Weight</b>	40 g

<sup>1)</sup> Max. tightening torque: 0.6 Nm.

## Ambient data

<b>Enclosure rating</b>	IP66 IP67 IP68 IP69K <sup>1)</sup>
<b>Ambient operating temperature</b>	-30 °C ... +70 °C <sup>2)</sup> -30 °C ... +60 °C
<b>Ambient temperature, storage</b>	-30 °C ... +75 °C
<b>UL File No.</b>	NRKH.E181493 & NRKH7.E181493

<sup>1)</sup> Only in case of correctly mounted IP69K connecting cable.

<sup>2)</sup> At  $U_V \leq 24$  V and  $I_A < 30$  mA.

Certificates

<b>EU declaration of conformity</b>	✓
<b>UK declaration of conformity</b>	✓
<b>ACMA declaration of conformity</b>	✓
<b>Moroccan declaration of conformity</b>	✓
<b>China RoHS</b>	✓
<b>ECOLAB certificate</b>	✓
<b>Photobiological safety (DIN EN 62471) certificate</b>	✓

Classifications

<b>ECLASS 5.0</b>	27270904
<b>ECLASS 5.1.4</b>	27270904
<b>ECLASS 6.0</b>	27270904
<b>ECLASS 6.2</b>	27270904
<b>ECLASS 7.0</b>	27270904
<b>ECLASS 8.0</b>	27270904
<b>ECLASS 8.1</b>	27270904
<b>ECLASS 9.0</b>	27270904
<b>ECLASS 10.0</b>	27270904
<b>ECLASS 11.0</b>	27270904
<b>ECLASS 12.0</b>	27270903
<b>ETIM 5.0</b>	EC002719
<b>ETIM 6.0</b>	EC002719
<b>ETIM 7.0</b>	EC002719
<b>ETIM 8.0</b>	EC002719
<b>UNSPSC 16.0901</b>	39121528

Connection diagram Cd-083

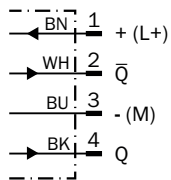

Characteristic curve WTB4S-3, 500 mm

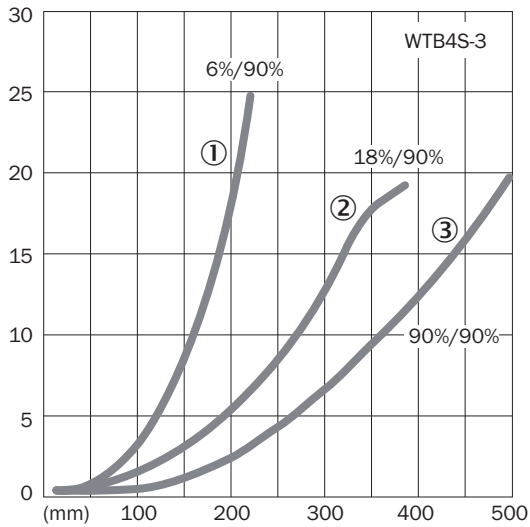

- ① Sensing range on black, 6% remission factor
- ② Sensing range on gray, 18% remission factor
- ③ Sensing range on white, 90% remission factor

Sensing range diagram WTB4S-3, 500 mm

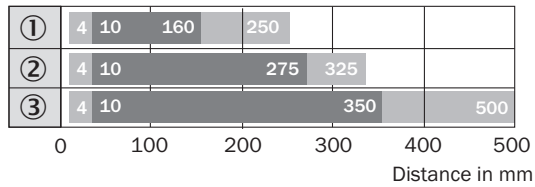

- Sensing range      ■ Sensing range max.
- ① Sensing range on black, 6% remission factor
  - ② Sensing range on gray, 18% remission factor
  - ③ Sensing range on white, 90% remission factor

### Dimensional drawing WTB4S-3V, WTF4S-3V, Single teach-in button

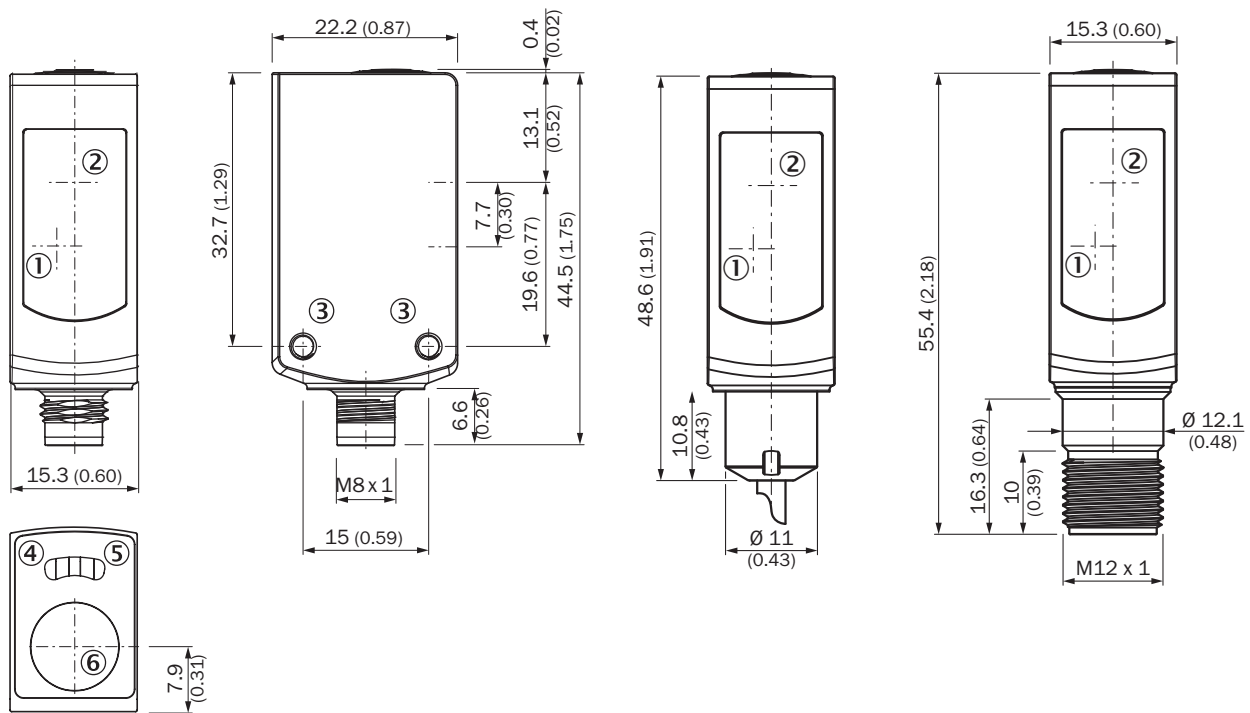





Dimensions in mm (inch)

- ① Center of optical axis, receiver
- ② Center of optical axis, sender
- ③ Threaded mounting hole M3
- ④ LED indicator yellow: Status of received light beam
- ⑤ LED indicator green: Supply voltage active
- ⑥ Teach-in button

## Recommended accessories

Other models and accessories → [www.sick.com/W4](http://www.sick.com/W4)

	Brief description	Type	part no.
Mounting systems			
	<ul style="list-style-type: none"> <li><b>Description:</b> Mounting bracket for floor mounting</li> <li><b>Material:</b> Stainless steel</li> <li><b>Details:</b> Stainless steel 1.4571</li> <li><b>Items supplied:</b> Mounting hardware included</li> <li><b>Suitable for:</b> W4S, W4F, W4S</li> </ul>	BEF-W4-B	2051630
	<ul style="list-style-type: none"> <li><b>Description:</b> Plate N02N for universal clamp bracket</li> <li><b>Material:</b> Stainless steel, stainless steel</li> <li><b>Details:</b> Stainless steel 1.4571 (sheet), Stainless steel 1.4408 (clamp)</li> <li><b>Items supplied:</b> Universal clamp (5322627), mounting hardware</li> <li><b>Usable for:</b> W4S-3 Glass, W10, W4SLG-3, W4S-3 Inox, W4S-3 Inox Glass, W9, W11-2, W12-3, W12-2 Laser, W12G, W12 Teflon, W16, W250, W250-2, PowerProx, W11G-2, TranspaTect, WTT12, UC12, P250, G6 Inox, W4S, W4SL-3V, W4SLG-3V, W4SL-3H</li> </ul>	BEF-KHS-N02N	2051618
connectors and cables			
	<ul style="list-style-type: none"> <li><b>Description:</b> Sensor/actuator cable, unshielded</li> <li><b>Connection type head A:</b> Female connector, M8, 4-pin, straight</li> <li><b>Connection type head B:</b> Flying leads</li> <li><b>Signal type:</b> Sensor/actuator cable</li> <li><b>Cable:</b> 5 m, 4-wire, PP</li> <li><b>Connection systems:</b> Flying leads</li> <li><b>Note:</b> This product is generally resistant to chemical cleaning agents (see ECOLAB) and other chemical compounds such as H2O2 and CH2O2. Before permanent installation is carried out, the material's resistance to the cleaning agent being used must be checked., Resistant against lactic acid &amp; hydrogen peroxide (H2O2)</li> <li><b>Application:</b> Hygienic and washdown zones, Drag chain operation, Robot, cold bending resistant, seawater resistant</li> </ul>	DOL-0804-G05MRN	6058511
	<ul style="list-style-type: none"> <li><b>Description:</b> Sensor/actuator cable, unshielded</li> <li><b>Connection type head A:</b> Female connector, M8, 4-pin, straight</li> <li><b>Connection type head B:</b> Flying leads</li> <li><b>Signal type:</b> Sensor/actuator cable</li> <li><b>Cable:</b> 5 m, 4-wire, PVC</li> <li><b>Connection systems:</b> Flying leads</li> <li><b>Note:</b> This product is generally resistant to chemical cleaning agents (see ECOLAB). Please do not use cleaning agents of any other Kind., Not resistant against lactic acid &amp; hydrogen peroxide (H2O2)</li> <li><b>Application:</b> Uncontaminated zones, Hygienic and washdown zones, Zones with chemicals</li> </ul>	YF8U54-050VA3XLEAX	6059194

## SICK AT A GLANCE

SICK is one of the leading manufacturers of intelligent sensors and sensor solutions for industrial applications. A unique range of products and services creates the perfect basis for controlling processes securely and efficiently, protecting individuals from accidents and preventing damage to the environment.

We have extensive experience in a wide range of industries and understand their processes and requirements. With intelligent sensors, we can deliver exactly what our customers need. In application centers in Europe, Asia and North America, system solutions are tested and optimized in accordance with customer specifications. All this makes us a reliable supplier and development partner.

Comprehensive services complete our offering: SICK LifeTime Services provide support throughout the machine life cycle and ensure safety and productivity.

For us, that is “Sensor Intelligence.”

## WORLDWIDE PRESENCE:

Contacts and other locations –[www.sick.com](http://www.sick.com)