



# LUT8U-11301

## LUT8

LUMINESCENCE SENSORS

**SICK**  
Sensor Intelligence.



Illustration may differ



## Ordering information

Type	part no.
LUT8U-11301	1047043

Other models and accessories → [www.sick.com/LUT8](http://www.sick.com/LUT8)

## Detailed technical data

### Features

<b>Housing design</b>	Large
<b>Dimensions (W x H x D)</b>	30.4 mm x 53 mm x 80 mm
<b>Light source</b>	LED, Ultraviolet light <sup>1)</sup>
<b>Light emission</b>	Long side
<b>Light spot size</b>	5 mm x 15 mm
<b>Light spot direction</b>	Vertical
<b>Receiving filters</b>	≤ 420 nm <sup>2)</sup>
<b>Wave length</b>	375 nm
<b>Working range</b>	20 mm ... 70 mm
<b>Sensing distance</b>	≤ 50 mm <sup>3)</sup>
<b>Receiving range</b>	450 nm ... 750 nm
<b>Adjustment</b>	Manual (rotary switch)
<b>Output function</b>	Light switching

<sup>1)</sup> Average service life: 100,000 h at T<sub>U</sub> = +25 °C.

<sup>2)</sup> Filter blocks shorter wavelengths to suppress background luminescence.

<sup>3)</sup> From leading edge of lens.

### Electronics

<b>Supply voltage</b>	12 V DC ... 30 V DC <sup>1)</sup>
<b>Ripple</b>	< 5 V <sub>pp</sub> <sup>2)</sup>

<sup>1)</sup> Limit values when operated in short-circuit protected network: max. 8 A.

<sup>2)</sup> May not fall below or exceed U<sub>y</sub> tolerances.

<sup>3)</sup> Without load.

<sup>4)</sup> With light/dark ratio 1:1.

<sup>5)</sup> Reference voltage DC 50 V.

<b>Current consumption</b>	< 100 mA <sup>3)</sup>
<b>Switching frequency</b>	2.5 kHz <sup>4)</sup>
<b>Response time</b>	200 µs
<b>Switching output</b>	PNP NPN
<b>Switching output (voltage)</b>	PNP: HIGH = $V_S - \leq 3 \text{ V}$ / LOW = approx. 0 V NPN: HIGH = approx. $U_V$ / LOW $\leq 2 \text{ V}$
<b>Switching mode</b>	Light switching
<b>Analog output</b>	0 mA ... 13 mA
<b>Output current <math>I_{\text{max}}</math></b>	100 mA
<b>Protection class</b>	II <sup>5)</sup>
<b>Circuit protection</b>	$U_V$ connections, reverse polarity protected Output Q short-circuit protected Interference pulse suppression
<b>Connection type</b>	Plug, M12, 5-pin

<sup>1)</sup> Limit values when operated in short-circuit protected network: max. 8 A.

<sup>2)</sup> May not fall below or exceed  $U_V$  tolerances.

<sup>3)</sup> Without load.

<sup>4)</sup> With light/dark ratio 1:1.

<sup>5)</sup> Reference voltage DC 50 V.

## Mechanics

<b>Housing material</b>	Zinc diecast
<b>Weight</b>	400 g

## Ambient data

<b>Ambient operating temperature</b>	-10 °C ... +55 °C
<b>Ambient temperature, storage</b>	-25 °C ... +75 °C
<b>Shock load</b>	According to IEC 60068
<b>Enclosure rating</b>	IP67

## Certificates

<b>EU declaration of conformity</b>	✓
<b>UK declaration of conformity</b>	✓
<b>ACMA declaration of conformity</b>	✓
<b>Moroccan declaration of conformity</b>	✓
<b>China RoHS</b>	✓
<b>Photobiological safety (IEC EN 62471)</b>	✓

## Classifications

<b>ECLASS 5.0</b>	27270908
<b>ECLASS 5.1.4</b>	27270908
<b>ECLASS 6.0</b>	27270908
<b>ECLASS 6.2</b>	27270908

<b>ECLASS 7.0</b>	27270908
<b>ECLASS 8.0</b>	27270908
<b>ECLASS 8.1</b>	27270908
<b>ECLASS 9.0</b>	27270908
<b>ECLASS 10.0</b>	27270908
<b>ECLASS 11.0</b>	27270908
<b>ECLASS 12.0</b>	27270908
<b>ETIM 5.0</b>	EC001822
<b>ETIM 6.0</b>	EC001822
<b>ETIM 7.0</b>	EC001822
<b>ETIM 8.0</b>	EC001822
<b>UNSPSC 16.0901</b>	39121528

### Dimensional drawing

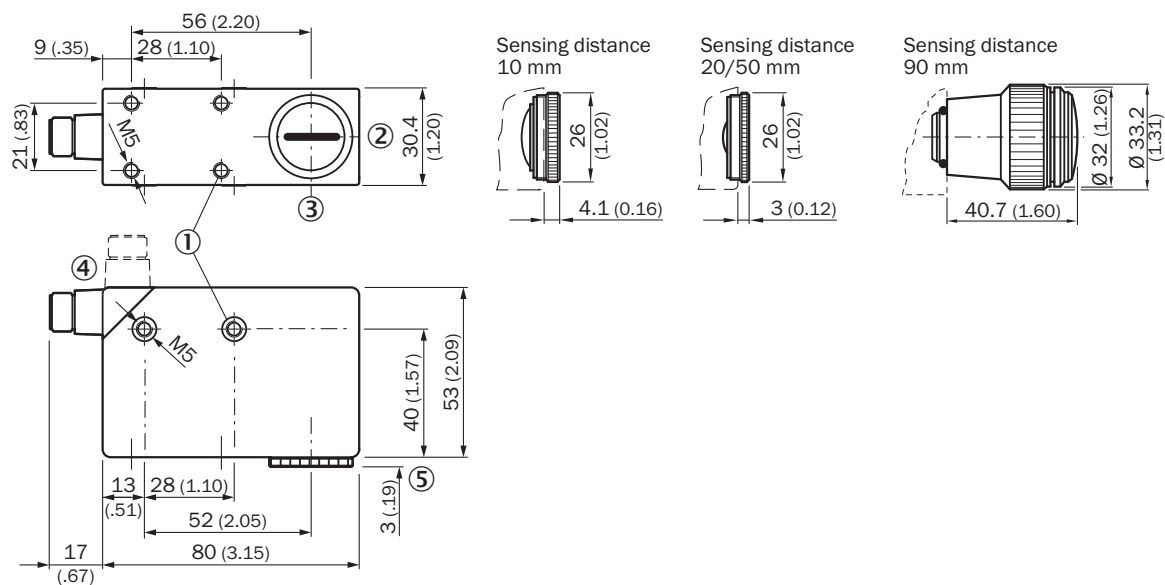

Dimensions in mm (inch)

- ① M5 threaded mounting hole, 5.5 mm deep
- ② Light spot direction
- ③ Center of optical axis
- ④ Connector M12 (rotatable up to 90°)
- ⑤ see dimensional drawings of lenses

## Adjustments

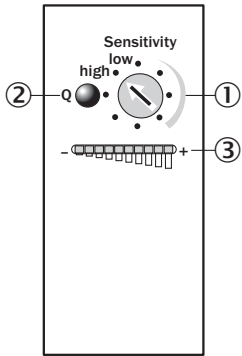

- ① Rotary selection switch
- ② Function signal indicator (yellow), switching output
- ③ bar graph (green), power-on left-hand LED

## Connection diagram Cd-312

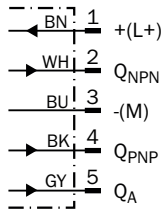

## Concept of operation Rotary switch

### 1. Position mark

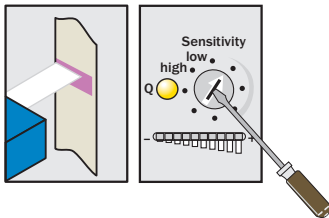

Turn "Sensitivity" rotary switch clockwise until yellow LED illuminates.

### 2. Position background

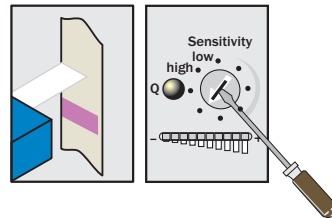

If yellow LED illuminates, turn "Sensitivity" rotary switch counter-clockwise until the yellow LED just goes out.

### Sensitivity setting

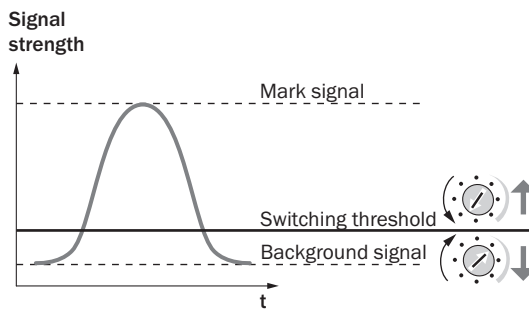

### Note

The bar graph display shows the luminescence intensity (regardless of switching threshold setting). Adjustments are intended for luminescence background suppression.

**Sensing distance**

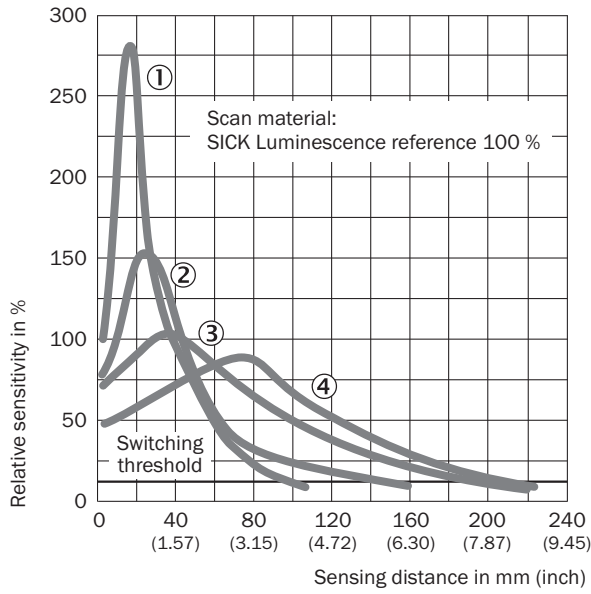

- ① Sensing distance 10 mm
- ② Sensing distance 20 mm
- ③ Sensing distance 50 mm
- ④ Sensing distance 90 mm

**Light spot size**

**Sensing distance 10 mm**

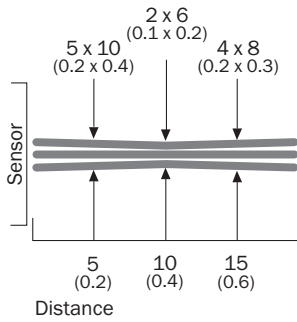

**Sensing distance 20 mm**

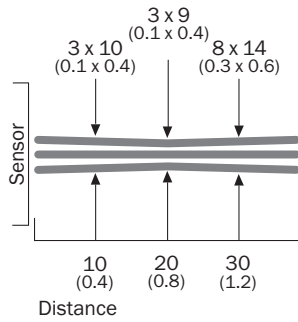

**Sensing distance 50 mm**

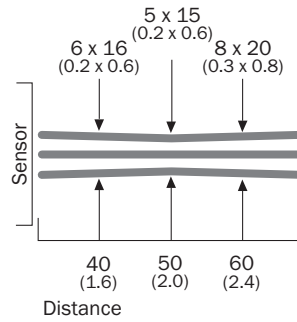



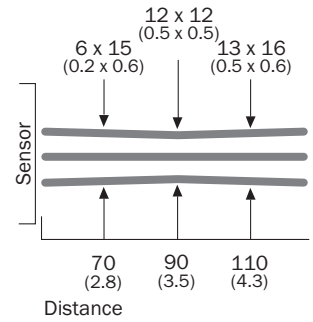



**Sensing distance 90 mm**





All dimensions in mm (inch)

## Recommended accessories

Other models and accessories → [www.sick.com/LUT8](http://www.sick.com/LUT8)

	Brief description	Type	part no.
reflectors and optics			
	<ul style="list-style-type: none"> <li><b>Description:</b> Lens, 10 mm sensing distance</li> </ul>	OBJ-LUT3-10	2016348
	<ul style="list-style-type: none"> <li><b>Description:</b> Lens, 20 mm sensing distance</li> </ul>	OBJ-LUT3-20	2016349
	<ul style="list-style-type: none"> <li><b>Description:</b> Lens, 50 mm sensing distance</li> </ul>	OBJ-LUT3-50	2016350
	<ul style="list-style-type: none"> <li><b>Description:</b> Lens, 90 mm scanning distance</li> </ul>	OBJ-026	1001326
	<ul style="list-style-type: none"> <li><b>Description:</b> Adapter ring for lens with M20 x 0.75 (OBJ-026/90 mm lens)</li> </ul>	AD-OBJ-01	2017097
Mounting systems			
	<ul style="list-style-type: none"> <li><b>Description:</b> Plate G for universal clamp bracket</li> <li><b>Material:</b> Steel</li> <li><b>Details:</b> Steel, zinc coated</li> <li><b>Items supplied:</b> Universal clamp (2022726), mounting hardware</li> <li><b>Usable for:</b> W34, LUT3, KT5-2, KT10, CS8, W24-2, KT8, KT8</li> </ul>	BEF-KHS-G01	2022464
	<ul style="list-style-type: none"> <li><b>Description:</b> Plate K for universal clamp bracket</li> <li><b>Material:</b> Steel</li> <li><b>Details:</b> Steel, zinc coated</li> <li><b>Items supplied:</b> Universal clamp (2022726), mounting hardware</li> <li><b>Usable for:</b> W11-2, W12-3, W14-2, W18-3, W23-2, W24-2, W27-3, W30, W32, W34, W36, PL50A, PL80A, P250, UC12, LUT3, KT2, KT5-2, KT8, CS8, DT2, DS30, DS40, W12-2 Laser, W16, W26, KT5</li> </ul>	BEF-KHS-K01	2022718

	Brief description	Type	part no.
connectors and cables			
	<ul style="list-style-type: none"> <li><b>Description:</b> Unshielded</li> <li><b>Connection type head A:</b> Female connector, M12, 5-pin, straight, A-coded</li> <li><b>Connection systems:</b> Screw-type terminals</li> <li><b>Permitted cross-section:</b> ≤ 0.75 mm<sup>2</sup></li> </ul>	DOS-1205-G	6009719
	<ul style="list-style-type: none"> <li><b>Description:</b> Unshielded</li> <li><b>Connection type head A:</b> Female connector, M12, 5-pin, angled, A-coded</li> <li><b>Connection systems:</b> Screw-type terminals</li> <li><b>Permitted cross-section:</b> ≤ 0.75 mm<sup>2</sup></li> </ul>	DOS-1205-W	6009720
	<ul style="list-style-type: none"> <li><b>Description:</b> Sensor/actuator cable, unshielded</li> <li><b>Connection type head A:</b> Female connector, M12, 5-pin, angled, A-coded</li> <li><b>Connection type head B:</b> Flying leads</li> <li><b>Signal type:</b> Sensor/actuator cable</li> <li><b>Cable:</b> 2 m, 5-wire, PVC</li> <li><b>Application:</b> Untaminated zones, Zones with chemicals</li> </ul>	YG2A15-020VB5XLEAX	2096215
	<ul style="list-style-type: none"> <li><b>Description:</b> Sensor/actuator cable, unshielded</li> <li><b>Connection type head A:</b> Female connector, M12, 5-pin, angled, A-coded</li> <li><b>Connection type head B:</b> Flying leads</li> <li><b>Signal type:</b> Sensor/actuator cable</li> <li><b>Cable:</b> 5 m, 5-wire, PVC</li> <li><b>Application:</b> Untaminated zones, Zones with chemicals</li> </ul>	YG2A15-050VB5XLEAX	2096216
	<ul style="list-style-type: none"> <li><b>Description:</b> Sensor/actuator cable, unshielded</li> <li><b>Connection type head A:</b> Female connector, M12, 5-pin, angled, A-coded</li> <li><b>Connection type head B:</b> Flying leads</li> <li><b>Signal type:</b> Sensor/actuator cable</li> <li><b>Cable:</b> 10 m, 5-wire, PVC</li> <li><b>Application:</b> Untaminated zones, Zones with chemicals</li> </ul>	YG2A15-100VB5XLEAX	2096217
	<ul style="list-style-type: none"> <li><b>Description:</b> Sensor/actuator cable, unshielded</li> <li><b>Connection type head A:</b> Female connector, M12, 5-pin, straight, A-coded</li> <li><b>Connection type head B:</b> Flying leads</li> <li><b>Signal type:</b> Sensor/actuator cable</li> <li><b>Cable:</b> 2 m, 5-wire, PVC</li> <li><b>Application:</b> Untaminated zones, Zones with chemicals</li> </ul>	YF2A15-020VB5XLEAX	2096239
	<ul style="list-style-type: none"> <li><b>Description:</b> Sensor/actuator cable, unshielded</li> <li><b>Connection type head A:</b> Female connector, M12, 5-pin, straight, A-coded</li> <li><b>Connection type head B:</b> Flying leads</li> <li><b>Signal type:</b> Sensor/actuator cable</li> <li><b>Cable:</b> 5 m, 5-wire, PVC</li> <li><b>Application:</b> Untaminated zones, Zones with chemicals</li> </ul>	YF2A15-050VB5XLEAX	2096240
	<ul style="list-style-type: none"> <li><b>Description:</b> Sensor/actuator cable, unshielded</li> <li><b>Connection type head A:</b> Female connector, M12, 5-pin, straight, A-coded</li> <li><b>Connection type head B:</b> Flying leads</li> <li><b>Signal type:</b> Sensor/actuator cable</li> <li><b>Cable:</b> 10 m, 5-wire, PVC</li> <li><b>Application:</b> Untaminated zones, Zones with chemicals</li> </ul>	YF2A15-100VB5XLEAX	2096241
	<ul style="list-style-type: none"> <li><b>Description:</b> Sensor/actuator cable, unshielded</li> <li><b>Connection type head A:</b> Female connector, M12, 5-pin, angled, A-coded</li> <li><b>Connection type head B:</b> Flying leads</li> <li><b>Signal type:</b> Sensor/actuator cable</li> <li><b>Cable:</b> 0.6 m, 5-wire, PVC</li> <li><b>Application:</b> Untaminated zones, Zones with chemicals</li> </ul>	YG2A15-C60VB5XLEAX	2145573
	<ul style="list-style-type: none"> <li><b>Description:</b> Sensor/actuator cable, unshielded</li> <li><b>Connection type head A:</b> Female connector, M12, 5-pin, angled, A-coded</li> <li><b>Connection type head B:</b> Flying leads</li> <li><b>Signal type:</b> Sensor/actuator cable</li> <li><b>Cable:</b> 1 m, 5-wire, PVC</li> <li><b>Application:</b> Untaminated zones, Zones with chemicals</li> </ul>	YG2A15-010VB5XLEAX	2145574
	<ul style="list-style-type: none"> <li><b>Description:</b> Sensor/actuator cable, unshielded</li> <li><b>Connection type head A:</b> Female connector, M12, 5-pin, angled, A-coded</li> <li><b>Connection type head B:</b> Flying leads</li> <li><b>Signal type:</b> Sensor/actuator cable</li> <li><b>Cable:</b> 3 m, 5-wire, PVC</li> </ul>	YG2A15-030VB5XLEAX	2145575

	Brief description	Type	part no.
	<ul style="list-style-type: none"> <li>• <b>Application:</b> Uncontaminated zones, Zones with chemicals</li> <li>• <b>Description:</b> Sensor/actuator cable, unshielded</li> <li>• <b>Connection type head A:</b> Female connector, M12, 5-pin, straight, A-coded</li> <li>• <b>Connection type head B:</b> Flying leads</li> <li>• <b>Signal type:</b> Sensor/actuator cable</li> <li>• <b>Cable:</b> 0.6 m, 5-wire, PVC</li> <li>• <b>Application:</b> Uncontaminated zones, Zones with chemicals</li> </ul>	YF2A15-C60VB5XLEAX	2145570
	<ul style="list-style-type: none"> <li>• <b>Description:</b> Sensor/actuator cable, unshielded</li> <li>• <b>Connection type head A:</b> Female connector, M12, 5-pin, straight, A-coded</li> <li>• <b>Connection type head B:</b> Flying leads</li> <li>• <b>Signal type:</b> Sensor/actuator cable</li> <li>• <b>Cable:</b> 3 m, 5-wire, PVC</li> <li>• <b>Application:</b> Uncontaminated zones, Zones with chemicals</li> </ul>	YF2A15-030VB5XLEAX	2145572

## SICK AT A GLANCE

SICK is one of the leading manufacturers of intelligent sensors and sensor solutions for industrial applications. A unique range of products and services creates the perfect basis for controlling processes securely and efficiently, protecting individuals from accidents and preventing damage to the environment.

We have extensive experience in a wide range of industries and understand their processes and requirements. With intelligent sensors, we can deliver exactly what our customers need. In application centers in Europe, Asia and North America, system solutions are tested and optimized in accordance with customer specifications. All this makes us a reliable supplier and development partner.

Comprehensive services complete our offering: SICK LifeTime Services provide support throughout the machine life cycle and ensure safety and productivity.

For us, that is “Sensor Intelligence.”

## WORLDWIDE PRESENCE:

Contacts and other locations –[www.sick.com](http://www.sick.com)