



LUT8U-11201

LUT8

LUMINESCENCE SENSORS

SICK
Sensor Intelligence.



Illustration may differ



Ordering information

Type	part no.
LUT8U-11201	1047042

Other models and accessories → www.sick.com/LUT8

Detailed technical data

Features

Housing design	Large
Dimensions (W x H x D)	30.4 mm x 53 mm x 80 mm
Light source	LED, Ultraviolet light ¹⁾
Light emission	Long side
Light spot size	3 mm x 9 mm
Light spot direction	Vertical
Receiving filters	≤ 420 nm ²⁾
Wave length	375 nm
Working range	10 mm ... 40 mm
Sensing distance	≤ 20 mm ³⁾
Receiving range	450 nm ... 750 nm
Adjustment	Manual (rotary switch)
Output function	Light switching

¹⁾ Average service life: 100,000 h at T_U = +25 °C.

²⁾ Filter blocks shorter wavelengths to suppress background luminescence.

³⁾ From leading edge of lens.

Electronics

Supply voltage	12 V DC ... 30 V DC ¹⁾
Ripple	< 5 V _{pp} ²⁾

¹⁾ Limit values when operated in short-circuit protected network: max. 8 A.

²⁾ May not fall below or exceed U_y tolerances.

³⁾ Without load.

⁴⁾ With light/dark ratio 1:1.

⁵⁾ Reference voltage DC 50 V.

Current consumption	< 100 mA ³⁾
Switching frequency	2.5 kHz ⁴⁾
Response time	200 µs
Switching output	PNP NPN
Switching output (voltage)	PNP: HIGH = $V_S - \leq 3 \text{ V}$ / LOW = approx. 0 V NPN: HIGH = approx. U_V / LOW $\leq 2 \text{ V}$
Switching mode	Light switching
Analog output	0 mA ... 13 mA
Output current I_{max}	100 mA
Protection class	II ⁵⁾
Circuit protection	U_V connections, reverse polarity protected Output Q short-circuit protected Interference pulse suppression
Connection type	Plug, M12, 5-pin

¹⁾ Limit values when operated in short-circuit protected network: max. 8 A.

²⁾ May not fall below or exceed U_V tolerances.

³⁾ Without load.

⁴⁾ With light/dark ratio 1:1.

⁵⁾ Reference voltage DC 50 V.

Mechanics

Housing material	Zinc diecast
Weight	400 g

Ambient data

Ambient operating temperature	-10 °C ... +55 °C
Ambient temperature, storage	-25 °C ... +75 °C
Shock load	According to IEC 60068
Enclosure rating	IP67

Certificates

EU declaration of conformity	✓
UK declaration of conformity	✓
ACMA declaration of conformity	✓
Moroccan declaration of conformity	✓
China RoHS	✓
Photobiological safety (IEC EN 62471)	✓

Classifications

ECLASS 5.0	27270908
ECLASS 5.1.4	27270908
ECLASS 6.0	27270908
ECLASS 6.2	27270908

ECLASS 7.0	27270908
ECLASS 8.0	27270908
ECLASS 8.1	27270908
ECLASS 9.0	27270908
ECLASS 10.0	27270908
ECLASS 11.0	27270908
ECLASS 12.0	27270908
ETIM 5.0	EC001822
ETIM 6.0	EC001822
ETIM 7.0	EC001822
ETIM 8.0	EC001822
UNSPSC 16.0901	39121528

Dimensional drawing

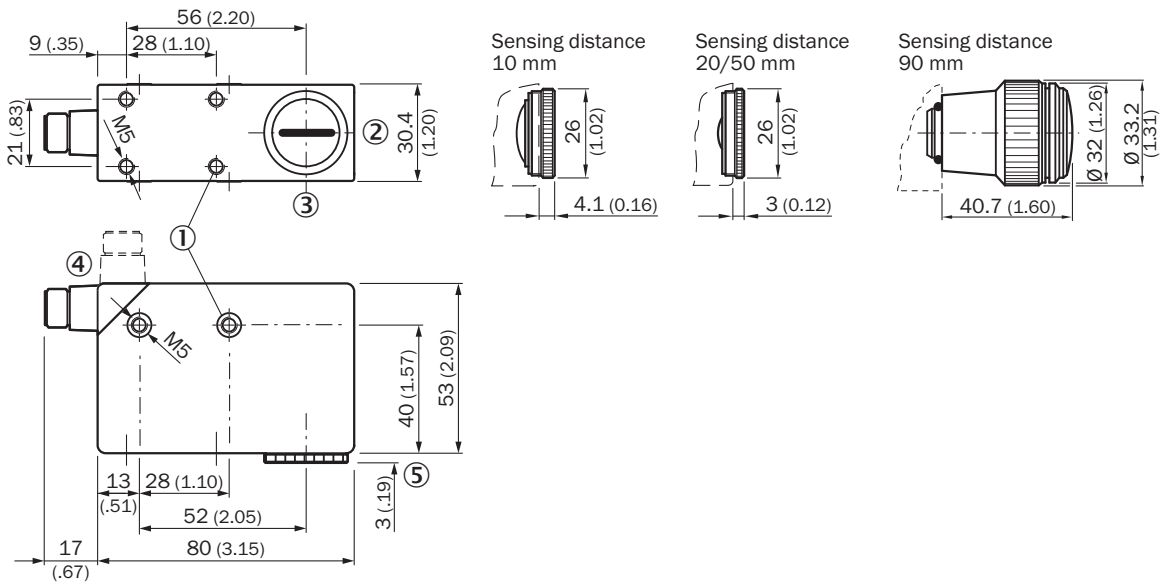

Dimensions in mm (inch)

- ① M5 threaded mounting hole, 5.5 mm deep
- ② Light spot direction
- ③ Center of optical axis
- ④ Connector M12 (rotatable up to 90°)
- ⑤ see dimensional drawings of lenses

Adjustments

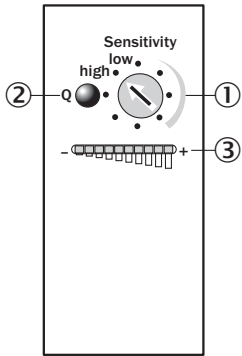

- ① Rotary selection switch
- ② Function signal indicator (yellow), switching output
- ③ bar graph (green), power-on left-hand LED

Connection diagram Cd-312

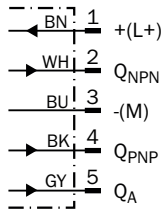

Concept of operation Rotary switch

1. Position mark

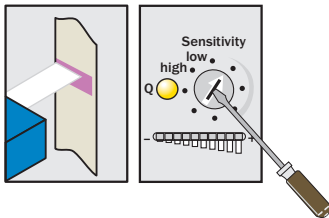

Turn "Sensitivity" rotary switch clockwise until yellow LED illuminates.

2. Position background

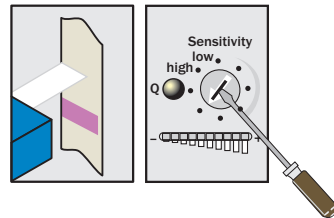

If yellow LED illuminates, turn "Sensitivity" rotary switch counter-clockwise until the yellow LED just goes out.

Sensitivity setting

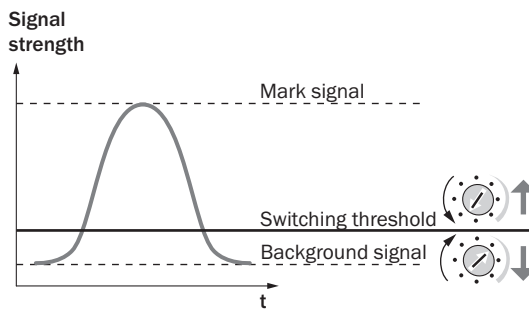

Note

The bar graph display shows the luminescence intensity (regardless of switching threshold setting). Adjustments are intended for luminescence background suppression.

Sensing distance

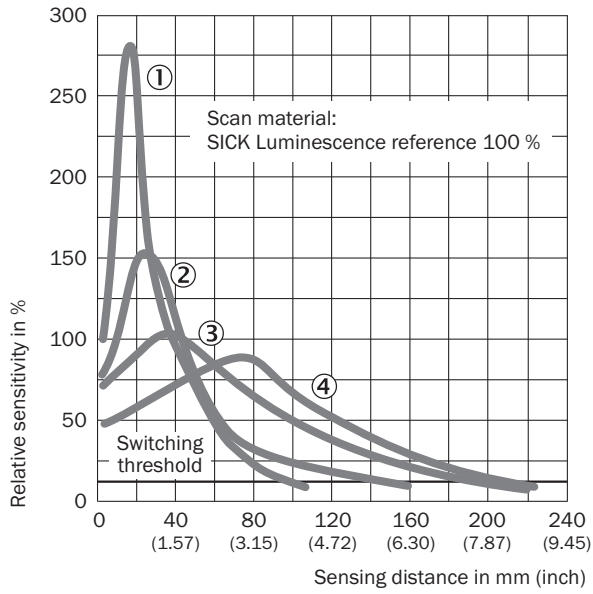

- ① Sensing distance 10 mm
- ② Sensing distance 20 mm
- ③ Sensing distance 50 mm
- ④ Sensing distance 90 mm

Light spot size

Sensing distance 10 mm

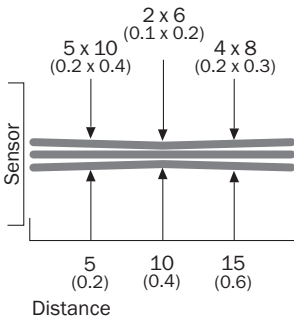

Sensing distance 20 mm

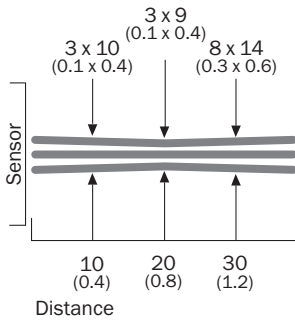

Sensing distance 50 mm

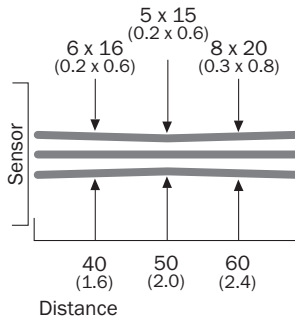



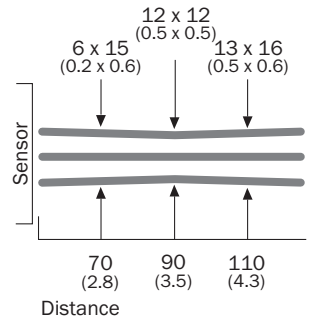



Sensing distance 90 mm





All dimensions in mm (inch)

Recommended accessories

Other models and accessories → www.sick.com/LUT8

	Brief description	Type	part no.
reflectors and optics			
	<ul style="list-style-type: none"> Description: Lens, 10 mm sensing distance 	OBJ-LUT3-10	2016348
	<ul style="list-style-type: none"> Description: Lens, 20 mm sensing distance 	OBJ-LUT3-20	2016349
	<ul style="list-style-type: none"> Description: Lens, 50 mm sensing distance 	OBJ-LUT3-50	2016350
	<ul style="list-style-type: none"> Description: Lens, 90 mm scanning distance 	OBJ-026	1001326
	<ul style="list-style-type: none"> Description: Adapter ring for lens with M20 x 0.75 (OBJ-026/90 mm lens) 	AD-OBJ-01	2017097
Mounting systems			
	<ul style="list-style-type: none"> Description: Plate G for universal clamp bracket Material: Steel Details: Steel, zinc coated Items supplied: Universal clamp (2022726), mounting hardware Usable for: W34, LUT3, KT5-2, KT10, CS8, W24-2, KT8, KT8 	BEF-KHS-G01	2022464
	<ul style="list-style-type: none"> Description: Plate K for universal clamp bracket Material: Steel Details: Steel, zinc coated Items supplied: Universal clamp (2022726), mounting hardware Usable for: W11-2, W12-3, W14-2, W18-3, W23-2, W24-2, W27-3, W30, W32, W34, W36, PL50A, PL80A, P250, UC12, LUT3, KT2, KT5-2, KT8, CS8, DT2, DS30, DS40, W12-2 Laser, W16, W26, KT5 	BEF-KHS-K01	2022718

	Brief description	Type	part no.
connectors and cables			
	<ul style="list-style-type: none"> Description: Unshielded Connection type head A: Female connector, M12, 5-pin, straight, A-coded Connection systems: Screw-type terminals Permitted cross-section: ≤ 0.75 mm² 	DOS-1205-G	6009719
	<ul style="list-style-type: none"> Description: Unshielded Connection type head A: Female connector, M12, 5-pin, angled, A-coded Connection systems: Screw-type terminals Permitted cross-section: ≤ 0.75 mm² 	DOS-1205-W	6009720
	<ul style="list-style-type: none"> Description: Sensor/actuator cable, unshielded Connection type head A: Female connector, M12, 5-pin, angled, A-coded Connection type head B: Flying leads Signal type: Sensor/actuator cable Cable: 2 m, 5-wire, PVC Application: Untaminated zones, Zones with chemicals 	YG2A15-020VB5XLEAX	2096215
	<ul style="list-style-type: none"> Description: Sensor/actuator cable, unshielded Connection type head A: Female connector, M12, 5-pin, angled, A-coded Connection type head B: Flying leads Signal type: Sensor/actuator cable Cable: 5 m, 5-wire, PVC Application: Untaminated zones, Zones with chemicals 	YG2A15-050VB5XLEAX	2096216
	<ul style="list-style-type: none"> Description: Sensor/actuator cable, unshielded Connection type head A: Female connector, M12, 5-pin, angled, A-coded Connection type head B: Flying leads Signal type: Sensor/actuator cable Cable: 10 m, 5-wire, PVC Application: Untaminated zones, Zones with chemicals 	YG2A15-100VB5XLEAX	2096217
	<ul style="list-style-type: none"> Description: Sensor/actuator cable, unshielded Connection type head A: Female connector, M12, 5-pin, straight, A-coded Connection type head B: Flying leads Signal type: Sensor/actuator cable Cable: 2 m, 5-wire, PVC Application: Untaminated zones, Zones with chemicals 	YF2A15-020VB5XLEAX	2096239
	<ul style="list-style-type: none"> Description: Sensor/actuator cable, unshielded Connection type head A: Female connector, M12, 5-pin, straight, A-coded Connection type head B: Flying leads Signal type: Sensor/actuator cable Cable: 5 m, 5-wire, PVC Application: Untaminated zones, Zones with chemicals 	YF2A15-050VB5XLEAX	2096240
	<ul style="list-style-type: none"> Description: Sensor/actuator cable, unshielded Connection type head A: Female connector, M12, 5-pin, straight, A-coded Connection type head B: Flying leads Signal type: Sensor/actuator cable Cable: 10 m, 5-wire, PVC Application: Untaminated zones, Zones with chemicals 	YF2A15-100VB5XLEAX	2096241
	<ul style="list-style-type: none"> Description: Sensor/actuator cable, unshielded Connection type head A: Female connector, M12, 5-pin, angled, A-coded Connection type head B: Flying leads Signal type: Sensor/actuator cable Cable: 0.6 m, 5-wire, PVC Application: Untaminated zones, Zones with chemicals 	YG2A15-C60VB5XLEAX	2145573
	<ul style="list-style-type: none"> Description: Sensor/actuator cable, unshielded Connection type head A: Female connector, M12, 5-pin, angled, A-coded Connection type head B: Flying leads Signal type: Sensor/actuator cable Cable: 1 m, 5-wire, PVC Application: Untaminated zones, Zones with chemicals 	YG2A15-010VB5XLEAX	2145574
	<ul style="list-style-type: none"> Description: Sensor/actuator cable, unshielded Connection type head A: Female connector, M12, 5-pin, angled, A-coded Connection type head B: Flying leads Signal type: Sensor/actuator cable Cable: 3 m, 5-wire, PVC 	YG2A15-030VB5XLEAX	2145575

	Brief description	Type	part no.
	<ul style="list-style-type: none"> • Application: Uncontaminated zones, Zones with chemicals • Description: Sensor/actuator cable, unshielded • Connection type head A: Female connector, M12, 5-pin, straight, A-coded • Connection type head B: Flying leads • Signal type: Sensor/actuator cable • Cable: 0.6 m, 5-wire, PVC • Application: Uncontaminated zones, Zones with chemicals 	YF2A15-C60VB5XLEAX	2145570
	<ul style="list-style-type: none"> • Description: Sensor/actuator cable, unshielded • Connection type head A: Female connector, M12, 5-pin, straight, A-coded • Connection type head B: Flying leads • Signal type: Sensor/actuator cable • Cable: 3 m, 5-wire, PVC • Application: Uncontaminated zones, Zones with chemicals 	YF2A15-030VB5XLEAX	2145572

SICK AT A GLANCE

SICK is one of the leading manufacturers of intelligent sensors and sensor solutions for industrial applications. A unique range of products and services creates the perfect basis for controlling processes securely and efficiently, protecting individuals from accidents and preventing damage to the environment.

We have extensive experience in a wide range of industries and understand their processes and requirements. With intelligent sensors, we can deliver exactly what our customers need. In application centers in Europe, Asia and North America, system solutions are tested and optimized in accordance with customer specifications. All this makes us a reliable supplier and development partner.

Comprehensive services complete our offering: SICK LifeTime Services provide support throughout the machine life cycle and ensure safety and productivity.

For us, that is “Sensor Intelligence.”

WORLDWIDE PRESENCE:

Contacts and other locations –www.sick.com