



WTB4S-3F3132V

W4

PHOTOELECTRIC SENSORS

**SICK**  
Sensor Intelligence.



Illustration may differ



### Ordering information

| Type          | part no. |
|---------------|----------|
| WTB4S-3F3132V | 1046401  |

Other models and accessories → [www.sick.com/W4](http://www.sick.com/W4)

### Detailed technical data

#### Features

|                                    |                                |                            |
|------------------------------------|--------------------------------|----------------------------|
| <b>Functional principle</b>        | Photoelectric proximity sensor |                            |
| <b>Functional principle detail</b> | Background suppression         |                            |
| <b>Sensing range max.</b>          | 4 mm ... 120 mm <sup>1)</sup>  |                            |
| <b>Sensing range</b>               | 10 mm ... 120 mm <sup>1)</sup> |                            |
| <b>Emitted beam</b>                | Light source                   | PinPoint LED <sup>2)</sup> |
|                                    | Type of light                  | Visible red light          |
|                                    | Light spot size (distance)     | Ø 2.5 mm (50 mm)           |
| <b>Key LED figures</b>             | Wave length                    | 650 nm                     |
|                                    | <b>Adjustment</b>              | Single teach-in button     |
| <b>Special applications</b>        | Hygienic and washdown zones    |                            |
| <b>Housing design</b>              | Washdown                       |                            |

<sup>1)</sup> Object with 90% remission (based on standard white, DIN 5033).

<sup>2)</sup> Average service life: 100,000 h at T<sub>J</sub> = +25 °C.

#### Safety-related parameters

|                                     |             |
|-------------------------------------|-------------|
| <b>MTTF<sub>D</sub></b>             | 1,211 years |
| <b>DC<sub>avg</sub></b>             | 0 %         |
| <b>T<sub>M</sub> (mission time)</b> | 20 years    |

## Electronics

|  |   |
|--|---|
| <b>Supply voltage <math>U_B</math></b> | 10 V DC ... 30 V DC <sup>1)</sup>                     |
| <b>Ripple</b>                          | < 5 V <sub>pp</sub> <sup>2)</sup>                     |
| <b>Current consumption</b>             | 30 mA <sup>3)</sup>                                   |
| <b>Protection class</b>                | III   |
| <b>Digital output</b>                  |   |
| Type                                   | PNP   |
| Switching mode                         | Dark switching  |
| Output current $I_{max}$               | ≤ 100 mA  |
| Response time                          | < 0.5 ms <sup>4)</sup>                                |
| Switching frequency                    | 1,000 Hz <sup>5)</sup>                                |
| <b>Circuit protection</b>              | A <sup>6)</sup><br>B <sup>7)</sup><br>C <sup>8)</sup> |

<sup>1)</sup> Limit values, reverse-polarity protected, operation in short-circuit protected network: max. 8 A.

<sup>2)</sup> May not fall below or exceed  $U_V$  tolerances.

<sup>3)</sup> Without load.

<sup>4)</sup> Signal transit time with resistive load.

<sup>5)</sup> With light/dark ratio 1:1.

<sup>6)</sup> A =  $V_S$  connections reverse-polarity protected.

<sup>7)</sup> B = inputs and output reverse-polarity protected.

<sup>8)</sup> C = interference suppression.

## Mechanics

|                               |   |
|-------------------------------|---|
| <b>Housing</b>                | Rectangular                                     |
| <b>Design detail</b>          | Slim  |
| <b>Dimensions (W x H x D)</b> | 15.25 mm x 49.2 mm x 22.2 mm                    |
| <b>Connection</b>             | Cable with connector M8, 3-pin <sup>1) 2)</sup> |
| <b>Connection detail</b>      |   |
| Length of cable (L)           | 150 mm <sup>2)</sup>                            |
| <b>Material</b>               |   |
| Housing                       | Metal, Stainless steel V4A (1.4404, 316L)       |
| Front screen                  | Plastic, PMMA                                   |
| Cable                         | Plastic, PVC                                    |
| <b>Weight</b>                 | 50 g  |

<sup>1)</sup> Max. tightening torque: 0.6 Nm.

<sup>2)</sup> Do not bend below 0 °C.

## Ambient data

|                                      |  |
|--------------------------------------|--|
| <b>Enclosure rating</b>              | IP66<br>IP67<br>IP68<br>IP69K                        |
| <b>Ambient operating temperature</b> | -30 °C ... +70 °C <sup>1)</sup><br>-30 °C ... +60 °C |

<sup>1)</sup> At  $U_V \leq 24$  V and  $I_A < 30$  mA.

|                                     |                              |
|-------------------------------------|------------------------------|
| <b>Ambient temperature, storage</b> | -30 °C ... +75 °C            |
| <b>UL File No.</b>                  | NRKH.E181493 & NRKH7.E181493 |

<sup>1)</sup> At UV ≤ 24 V and IA < 30 mA.

### Certificates

|  |   |
|--|---|
| <b>EU declaration of conformity</b>                      | ✓ |
| <b>UK declaration of conformity</b>                      | ✓ |
| <b>ACMA declaration of conformity</b>                    | ✓ |
| <b>Moroccan declaration of conformity</b>                | ✓ |
| <b>China RoHS</b>  | ✓ |
| <b>ECOLAB certificate</b>                                | ✓ |
| <b>Photobiological safety (DIN EN 62471) certificate</b> | ✓ |

### Classifications

|                       |          |
|-----------------------|----------|
| <b>ECLASS 5.0</b>     | 27270904 |
| <b>ECLASS 5.1.4</b>   | 27270904 |
| <b>ECLASS 6.0</b>     | 27270904 |
| <b>ECLASS 6.2</b>     | 27270904 |
| <b>ECLASS 7.0</b>     | 27270904 |
| <b>ECLASS 8.0</b>     | 27270904 |
| <b>ECLASS 8.1</b>     | 27270904 |
| <b>ECLASS 9.0</b>     | 27270904 |
| <b>ECLASS 10.0</b>    | 27270904 |
| <b>ECLASS 11.0</b>    | 27270904 |
| <b>ECLASS 12.0</b>    | 27270903 |
| <b>ETIM 5.0</b>       | EC002719 |
| <b>ETIM 6.0</b>       | EC002719 |
| <b>ETIM 7.0</b>       | EC002719 |
| <b>ETIM 8.0</b>       | EC002719 |
| <b>UNSPSC 16.0901</b> | 39121528 |

### Connection diagram Cd-045

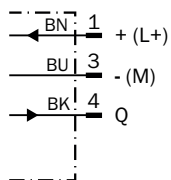

### Characteristic curve WTB4S-3, 120 mm

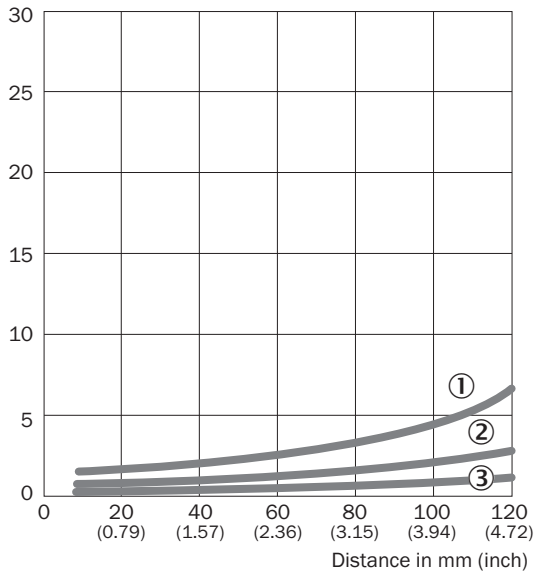

- ① Sensing range on black, 6% remission factor
- ② Sensing range on gray, 18% remission factor
- ③ Sensing range on white, 90% remission factor

### Light spot size

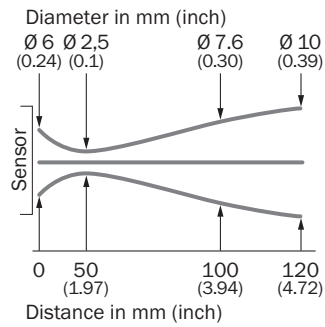

### Sensing range diagram WTB4S-3, 120 mm

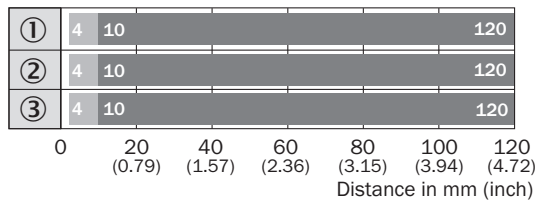

- ① Sensing range on black, 6% remission factor
- ② Sensing range on gray, 18% remission factor
- ③ Sensing range on white, 90% remission factor

### Dimensional drawing WTB4S-3V, WTF4S-3V, Single teach-in button

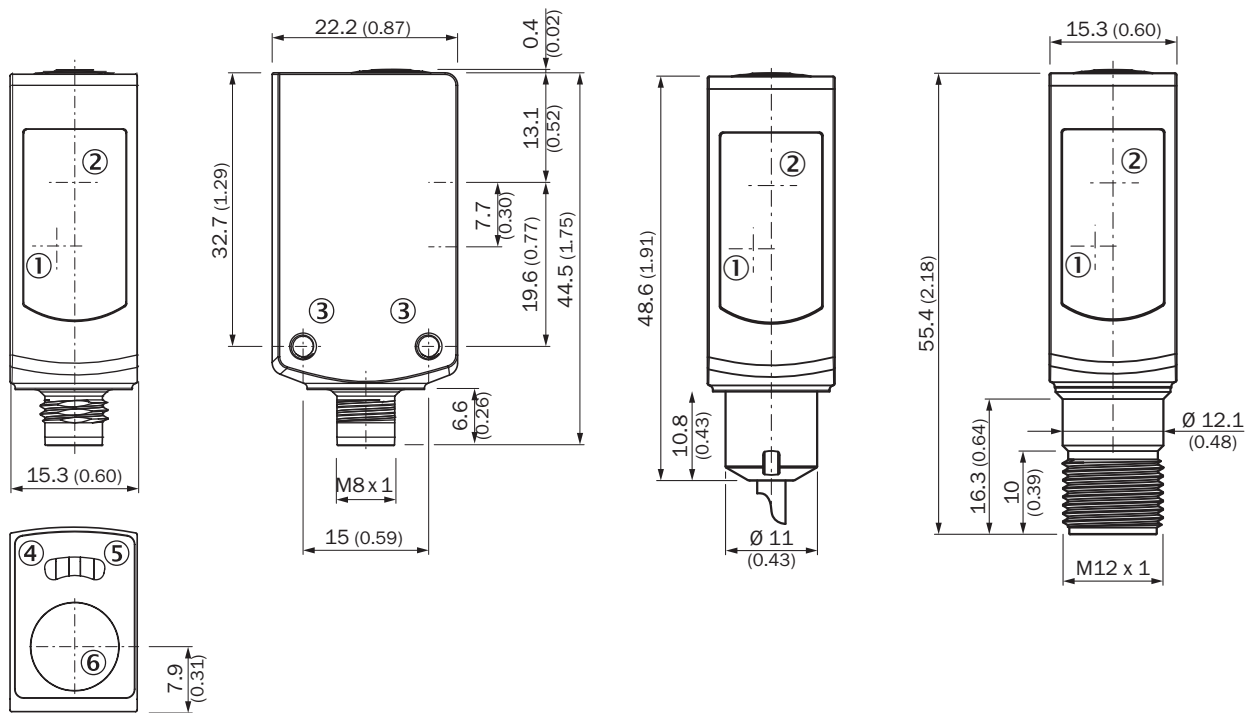



Dimensions in mm (inch)

- ① Center of optical axis, receiver
- ② Center of optical axis, sender
- ③ Threaded mounting hole M3
- ④ LED indicator yellow: Status of received light beam
- ⑤ LED indicator green: Supply voltage active
- ⑥ Teach-in button

## Recommended accessories

Other models and accessories → [www.sick.com/W4](http://www.sick.com/W4)

|   | Brief description   | Type         | part no. |
|---|---|--------------|----------|
| Mounting systems  |   |              |          |
|  | <ul style="list-style-type: none"> <li><b>Description:</b> Mounting bracket for floor mounting</li> <li><b>Material:</b> Stainless steel</li> <li><b>Details:</b> Stainless steel 1.4571</li> <li><b>Items supplied:</b> Mounting hardware included</li> <li><b>Suitable for:</b> W4S, W4F, W4S</li> </ul>  | BEF-W4-B     | 2051630  |
|  | <ul style="list-style-type: none"> <li><b>Description:</b> Plate N02N for universal clamp bracket</li> <li><b>Material:</b> Stainless steel, stainless steel</li> <li><b>Details:</b> Stainless steel 1.4571 (sheet), Stainless steel 1.4408 (clamp)</li> <li><b>Items supplied:</b> Universal clamp (5322627), mounting hardware</li> <li><b>Usable for:</b> W4S-3 Glass, W10, W4SLG-3, W4S-3 Inox, W4S-3 Inox Glass, W9, W11-2, W12-3, W12-2 Laser, W12G, W12 Teflon, W16, W250, W250-2, PowerProx, W11G-2, TranspaTect, WTT12, UC12, P250, G6 Inox, W4S, W4SL-3V, W4SLG-3V, W4SL-3H</li> </ul> | BEF-KHS-N02N | 2051618  |

|   | Brief description  | Type               | part no. |
|---|--|--------------------|----------|
| connectors and cables   |  |                    |          |
|    | <ul style="list-style-type: none"> <li>• <b>Description:</b> Sensor/actuator cable, unshielded</li> <li>• <b>Connection type head A:</b> Female connector, M8, 3-pin, straight</li> <li>• <b>Connection type head B:</b> Flying leads</li> <li>• <b>Signal type:</b> Sensor/actuator cable</li> <li>• <b>Cable:</b> 5 m, 4-wire, PP</li> <li>• <b>Connection systems:</b> Flying leads</li> <li>• <b>Note:</b> This product is generally resistant to chemical cleaning agents (see ECOLAB) and other chemical compounds such as H2O2 and CH2O2. Before permanent installation is carried out, the material's resistance to the cleaning agent being used must be checked., Resistant against lactic acid &amp; hydrogen peroxide (H2O2)</li> <li>• <b>Application:</b> Hygienic and washdown zones, Drag chain operation, Robot, cold bending resistant, seawater resistant</li> </ul>  | DOL-0803-G05MRN    | 6058505  |
|    | <ul style="list-style-type: none"> <li>• <b>Description:</b> Sensor/actuator cable, unshielded</li> <li>• <b>Connection type head A:</b> Female connector, M8, 3-pin, straight</li> <li>• <b>Connection type head B:</b> Flying leads</li> <li>• <b>Signal type:</b> Sensor/actuator cable</li> <li>• <b>Cable:</b> 5 m, 3-wire, PVC</li> <li>• <b>Connection systems:</b> Flying leads</li> <li>• <b>Note:</b> This product is generally resistant to chemical cleaning agents (see ECOLAB). Please do not use cleaning agents of any other Kind., Not resistant against lactic acid &amp; hydrogen peroxide (H2O2)</li> <li>• <b>Application:</b> Uncontaminated zones, Hygienic and washdown zones, Zones with chemicals</li> </ul>   | YF8U53-050VA1XLEAX | 6059178  |
|    | <ul style="list-style-type: none"> <li>• <b>Description:</b> Sensor/actuator cable, unshielded</li> <li>• <b>Connection type head A:</b> Female connector, M8, 3-pin, straight</li> <li>• <b>Connection type head B:</b> Flying leads</li> <li>• <b>Signal type:</b> Sensor/actuator cable</li> <li>• <b>Cable:</b> 15 m, 4-wire, PP</li> <li>• <b>Connection systems:</b> Flying leads</li> <li>• <b>Note:</b> This product is generally resistant to chemical cleaning agents (see ECOLAB) and other chemical compounds such as H2O2 and CH2O2. Before permanent installation is carried out, the material's resistance to the cleaning agent being used must be checked., Resistant against lactic acid &amp; hydrogen peroxide (H2O2)</li> <li>• <b>Application:</b> Hygienic and washdown zones, Drag chain operation, Robot, cold bending resistant, seawater resistant</li> </ul> | YF8P13-150PA1XLEAX | 2146839  |
|  | <ul style="list-style-type: none"> <li>• <b>Description:</b> Sensor/actuator cable, unshielded</li> <li>• <b>Connection type head A:</b> Female connector, M8, 3-pin, straight</li> <li>• <b>Connection type head B:</b> Flying leads</li> <li>• <b>Signal type:</b> Sensor/actuator cable</li> <li>• <b>Cable:</b> 20 m, 4-wire, PP</li> <li>• <b>Connection systems:</b> Flying leads</li> <li>• <b>Note:</b> This product is generally resistant to chemical cleaning agents (see ECOLAB) and other chemical compounds such as H2O2 and CH2O2. Before permanent installation is carried out, the material's resistance to the cleaning agent being used must be checked., Resistant against lactic acid &amp; hydrogen peroxide (H2O2)</li> <li>• <b>Application:</b> Hygienic and washdown zones, Drag chain operation, Robot, cold bending resistant, seawater resistant</li> </ul> | YF8P13-200PA1XLEAX | 2146841  |
|  | <ul style="list-style-type: none"> <li>• <b>Description:</b> Sensor/actuator cable, unshielded</li> <li>• <b>Connection type head A:</b> Female connector, M8, 3-pin, straight</li> <li>• <b>Connection type head B:</b> Flying leads</li> <li>• <b>Signal type:</b> Sensor/actuator cable</li> <li>• <b>Cable:</b> 30 m, 4-wire, PP</li> <li>• <b>Connection systems:</b> Flying leads</li> <li>• <b>Note:</b> This product is generally resistant to chemical cleaning agents (see ECOLAB) and other chemical compounds such as H2O2 and CH2O2. Before permanent installation is carried out, the material's resistance to the cleaning agent being used must be checked., Resistant against lactic acid &amp; hydrogen peroxide (H2O2)</li> <li>• <b>Application:</b> Hygienic and washdown zones, Drag chain operation, Robot, cold bending resistant, seawater resistant</li> </ul> | YF8P13-300PA1XLEAX | 2146842  |
|  | <ul style="list-style-type: none"> <li>• <b>Description:</b> Sensor/actuator cable, unshielded</li> <li>• <b>Connection type head A:</b> Female connector, M8, 3-pin, straight</li> <li>• <b>Connection type head B:</b> Flying leads</li> <li>• <b>Signal type:</b> Sensor/actuator cable</li> <li>• <b>Cable:</b> 40 m, 4-wire, PP</li> <li>• <b>Connection systems:</b> Flying leads</li> <li>• <b>Note:</b> This product is generally resistant to chemical cleaning agents (see ECOLAB) and other chemical compounds such as H2O2 and CH2O2. Before permanent installation is carried out, the material's resistance to the cleaning agent being used must be checked., Resistant against lactic acid &amp; hydrogen peroxide (H2O2)</li> <li>• <b>Application:</b> Hygienic and washdown zones, Drag chain operation, Robot, cold bending resistant, seawater resistant</li> </ul> | YF8P13-400PA1XLEAX | 2146843  |

## SICK AT A GLANCE

SICK is one of the leading manufacturers of intelligent sensors and sensor solutions for industrial applications. A unique range of products and services creates the perfect basis for controlling processes securely and efficiently, protecting individuals from accidents and preventing damage to the environment.

We have extensive experience in a wide range of industries and understand their processes and requirements. With intelligent sensors, we can deliver exactly what our customers need. In application centers in Europe, Asia and North America, system solutions are tested and optimized in accordance with customer specifications. All this makes us a reliable supplier and development partner.

Comprehensive services complete our offering: SICK LifeTime Services provide support throughout the machine life cycle and ensure safety and productivity.

For us, that is “Sensor Intelligence.”

## WORLDWIDE PRESENCE:

Contacts and other locations –[www.sick.com](http://www.sick.com)