



WTB4S-3N1362V

W4

PHOTOELECTRIC SENSORS

SICK
Sensor Intelligence.



Illustration may differ



Ordering information

Type	part no.
WTB4S-3N1362V	1046393

Other models and accessories → www.sick.com/W4

Detailed technical data

Features

Functional principle	Photoelectric proximity sensor	
Functional principle detail	Background suppression	
Sensing range max.	4 mm ... 500 mm ¹⁾	
Sensing range	10 mm ... 350 mm ¹⁾	
Emitted beam	Light source	PinPoint LED ²⁾
	Type of light	Visible red light
	Light spot size (distance)	Ø 6.5 mm (150 mm)
Key LED figures	Wave length	650 nm
	Adjustment	Single teach-in button
Special applications	Hygienic and washdown zones	
Housing design	Washdown	

¹⁾ Object with 90% remission (based on standard white, DIN 5033).

²⁾ Average service life: 100,000 h at T_J = +25 °C.

Safety-related parameters

MTTF_D	1,071 years
DC_{avg}	0 %
T_M (mission time)	20 years

Electronics

Supply voltage U_B	10 V DC ... 30 V DC ¹⁾
Ripple	< 5 V _{pp} ²⁾
Current consumption	30 mA ³⁾
Protection class	III
Digital output	
Type	NPN
Switching mode	Light switching
Output current I _{max.}	≤ 100 mA
Response time	< 0.5 ms ⁴⁾
Switching frequency	1,000 Hz ⁵⁾
Circuit protection	A ⁶⁾ B ⁷⁾ C ⁸⁾

¹⁾ Limit values, reverse-polarity protected, operation in short-circuit protected network: max. 8 A.

²⁾ May not fall below or exceed U_γ tolerances.

³⁾ Without load.

⁴⁾ Signal transit time with resistive load.

⁵⁾ With light/dark ratio 1:1.

⁶⁾ A = V_S connections reverse-polarity protected.

⁷⁾ B = inputs and output reverse-polarity protected.

⁸⁾ C = interference suppression.

Mechanics

Housing	Rectangular
Design detail	Slim
Dimensions (W x H x D)	15.25 mm x 49.2 mm x 22.2 mm
Connection	Cable, 3-wire, 2 m ¹⁾
Connection detail	
Conductor size	0.14 mm ²
Length of cable (L)	2 m ¹⁾
Material	
Housing	Metal, Stainless steel V4A (1.4404, 316L)
Front screen	Plastic, PMMA
Cable	Plastic, PVC
Weight	80 g

¹⁾ Do not bend below 0 °C.

Ambient data

Enclosure rating	IP66 IP67 IP68 IP69K
Ambient operating temperature	-30 °C ... +70 °C ¹⁾ -30 °C ... +60 °C

¹⁾ At UV ≤ 24 V and IA < 30 mA.

Ambient temperature, storage	-30 °C ... +75 °C
UL File No.	NRKH.E181493 & NRKH7.E181493

¹⁾ At UV ≤ 24 V and IA < 30 mA.

Certificates

EU declaration of conformity	✓
UK declaration of conformity	✓
ACMA declaration of conformity	✓
Moroccan declaration of conformity	✓
China RoHS	✓
ECOLAB certificate	✓
Photobiological safety (DIN EN 62471) certificate	✓

Classifications

ECLASS 5.0	27270904
ECLASS 5.1.4	27270904
ECLASS 6.0	27270904
ECLASS 6.2	27270904
ECLASS 7.0	27270904
ECLASS 8.0	27270904
ECLASS 8.1	27270904
ECLASS 9.0	27270904
ECLASS 10.0	27270904
ECLASS 11.0	27270904
ECLASS 12.0	27270903
ETIM 5.0	EC002719
ETIM 6.0	EC002719
ETIM 7.0	EC002719
ETIM 8.0	EC002719
UNSPSC 16.0901	39121528

Connection diagram Cd-044

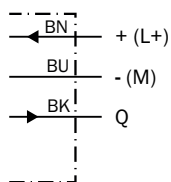

Characteristic curve WTB4S-3, 500 mm

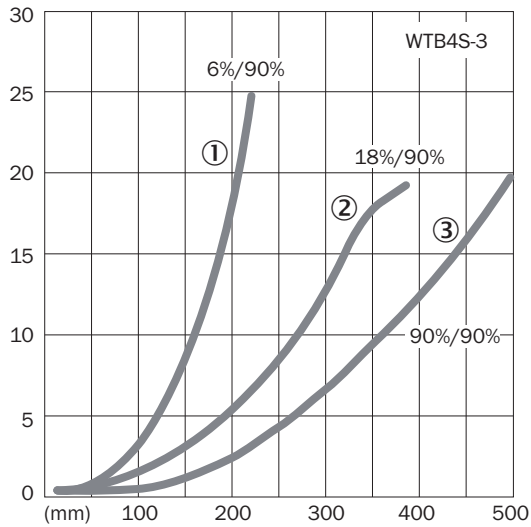

- ① Sensing range on black, 6% remission factor
- ② Sensing range on gray, 18% remission factor
- ③ Sensing range on white, 90% remission factor

Sensing range diagram WTB4S-3, 500 mm

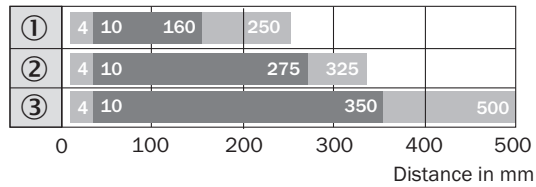

- Sensing range ■ Sensing range max.
- ① Sensing range on black, 6% remission factor
 - ② Sensing range on gray, 18% remission factor
 - ③ Sensing range on white, 90% remission factor

Dimensional drawing WTB4S-3V, WTF4S-3V, Single teach-in button

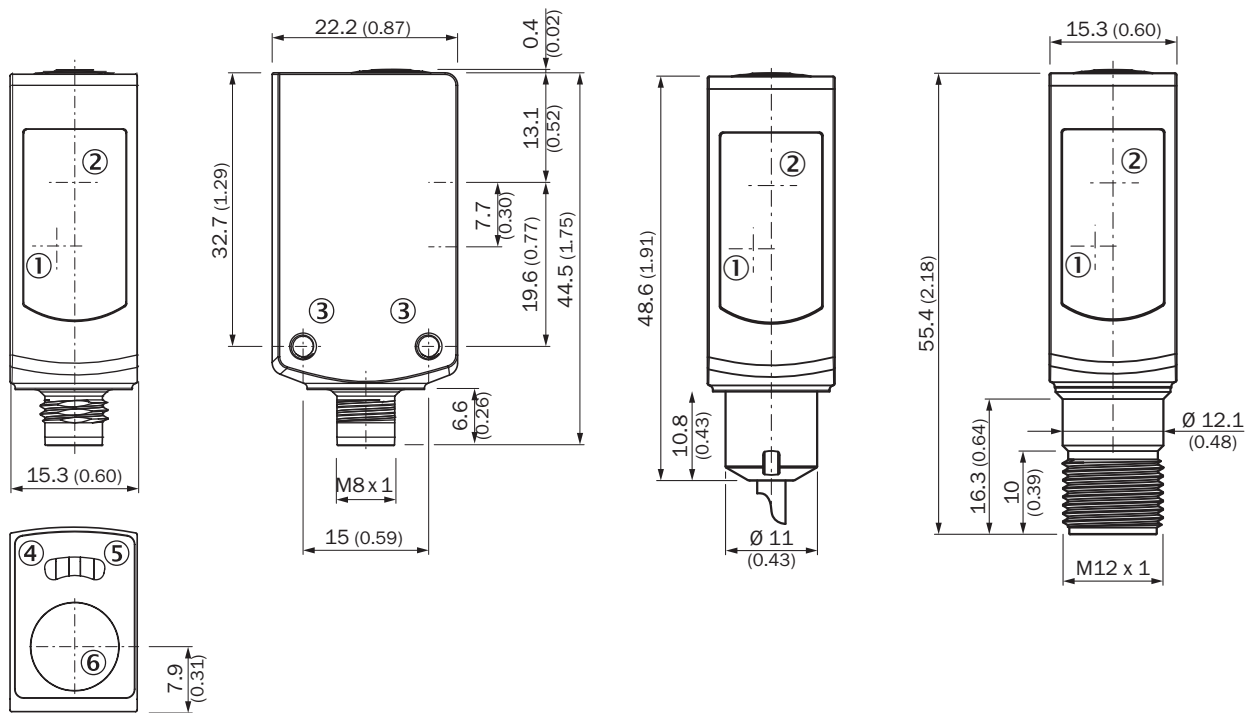



Dimensions in mm (inch)

- ① Center of optical axis, receiver
- ② Center of optical axis, sender
- ③ Threaded mounting hole M3
- ④ LED indicator yellow: Status of received light beam
- ⑤ LED indicator green: Supply voltage active
- ⑥ Teach-in button

Recommended accessories

Other models and accessories → www.sick.com/W4

	Brief description	Type	part no.
Mounting systems			
	<ul style="list-style-type: none"> Description: Mounting bracket for floor mounting Material: Stainless steel Details: Stainless steel 1.4571 Items supplied: Mounting hardware included Suitable for: W4S, W4F, W4S 	BEF-W4-B	2051630
	<ul style="list-style-type: none"> Description: Plate N02N for universal clamp bracket Material: Stainless steel, stainless steel Details: Stainless steel 1.4571 (sheet), Stainless steel 1.4408 (clamp) Items supplied: Universal clamp (5322627), mounting hardware Usable for: W4S-3 Glass, W10, W4SLG-3, W4S-3 Inox, W4S-3 Inox Glass, W9, W11-2, W12-3, W12-2 Laser, W12G, W12 Teflon, W16, W250, W250-2, PowerProx, W11G-2, TranspaTect, WTT12, UC12, P250, G6 Inox, W4S, W4SL-3V, W4SLG-3V, W4SL-3H 	BEF-KHS-N02N	2051618
connectors and cables			
	<ul style="list-style-type: none"> Description: Unshielded Connection type head A: Male connector, M8, 3-pin, straight, A-coded Connection systems: Screw-type terminals Permitted cross-section: 0.14 mm² ... 0.5 mm² 	STE-0803-G	6037322

SICK AT A GLANCE

SICK is one of the leading manufacturers of intelligent sensors and sensor solutions for industrial applications. A unique range of products and services creates the perfect basis for controlling processes securely and efficiently, protecting individuals from accidents and preventing damage to the environment.

We have extensive experience in a wide range of industries and understand their processes and requirements. With intelligent sensors, we can deliver exactly what our customers need. In application centers in Europe, Asia and North America, system solutions are tested and optimized in accordance with customer specifications. All this makes us a reliable supplier and development partner.

Comprehensive services complete our offering: SICK LifeTime Services provide support throughout the machine life cycle and ensure safety and productivity.

For us, that is “Sensor Intelligence.”

WORLDWIDE PRESENCE:

Contacts and other locations –www.sick.com