



CLV505-1110

CLV50x

FIXED MOUNT BARCODE SCANNERS

SICK
Sensor Intelligence.



Ordering information

Type	part no.
CLV505-1110	1046320

Other models and accessories → www.sick.com/CLV50x



Detailed technical data

Features

Version	Mid Range
Connection type	USB
Reading field	Front
Sensor type	Line scanner
Optical focus	Fixed focus
Light source	Light spot, laser, Visible, Red, 650 nm
Laser class	2, complies with 21 CFR 1040.10 except for the conformance according to "Laser Notice No. 56" from May 8, 2019 (EN 60825-1:2014+A11:2021, IEC 60825-1:2014)
Aperture angle	≤ 40°
Reading distance	60 mm ... 330 mm ¹⁾
Scanning frequency	≤ 1,000 Hz
Code resolution	0.15 mm ... 1 mm

¹⁾ For details see reading field diagram.

Mechanics/electronics

Connection type	1 x male connector, USB-A (1.5 m)
Supply voltage	5 V DC, ± 10 %
Power consumption	typ. 205 ... 500 mA
Housing color	Light blue (RAL 5012)
Window material	Plastic
Enclosure rating	IP54
Protection class	III
Weight	+ 30 g, without cable
Dimensions (L x W x H)	29 mm x 34.5 mm x 17 mm
MTBF	10,000 h

Performance

Readable code structures	1D codes
Bar code types	Code 11, Code 39, Code 128, Code 93, Codabar, JAN, UPC / GTIN / EAN, Interleaved 2 of 5, 2/5 Industrial, Matrix 2 of 5, China Post, GS1 DataBar (Expanded, Limited, Truncated, 14 Stacked, Expanded Stacked, Stacked, with Composite A/B), IATA, ISBN-ISMN-ISSN, Korea Post, MSI/Plessey, UK/Plessey, S-Code, Telepen, Code 39 Trioptic
Code printing process	Label (printed codes)

Interfaces

USB	✓
Reading pulse	Button at housing, serial command
Optical indicators	1 LED
Acoustic indicators	Beeper/buzzer

Ambient data

Electromagnetic compatibility (EMC)	EN 61000-6-3 (2007-01) ¹⁾
Ambient operating temperature	0 °C ... +45 °C
Relative humidity	± 90 %, Non-condensing
Ambient light immunity	2,000 lx
Bar code print contrast (PCS)	≥ 45 %

¹⁾ For ESD safe installation.

Certificates

EU declaration of conformity	✓
China RoHS	✓
cULus certificate	✓
Information according to Art. 3 of Data Act (Regulation EU 2023/2854)	✓

Classifications

ECLASS 5.0	27280102
ECLASS 5.1.4	27280102
ECLASS 6.0	27280102
ECLASS 6.2	27280102
ECLASS 7.0	27280102
ECLASS 8.0	27280102
ECLASS 8.1	27280102
ECLASS 9.0	27280102
ECLASS 10.0	27280102
ECLASS 11.0	27280102
ECLASS 12.0	27280102
ETIM 5.0	EC002550
ETIM 6.0	EC002550
ETIM 7.0	EC002550
ETIM 8.0	EC002550
UNSPSC 16.0901	43211701

Dimensional drawing

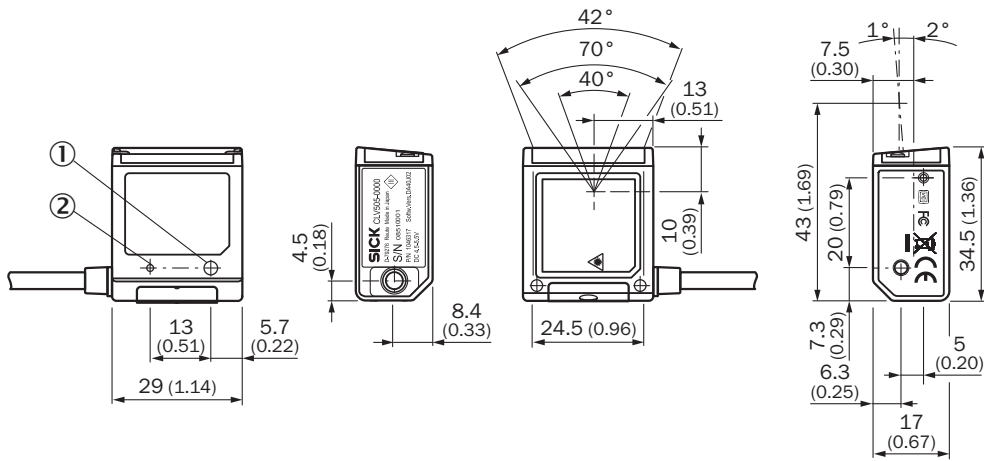

Dimensions in mm (inch)

- ① M3; 5 deep
- ② Ø 2; 1.0 deep

Reading field diagram

Reading field height in mm (inch)

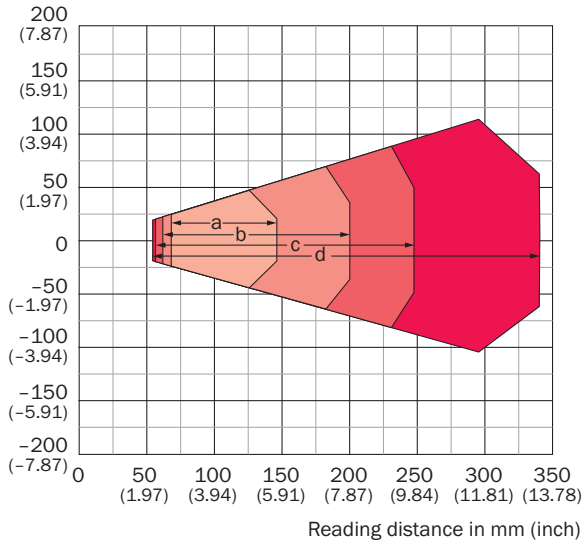

Resolution

- a: 0.15 mm (5.9 mil)
- b: 0.25 mm (9.8 mil)
- c: 0.50 mm (19.7 mil)
- d: 1.00 mm (39.4 mil)

Recommended accessories

Other models and accessories → www.sick.com/CLV50x

	Brief description	Type	part no.
Mounting systems			
	<ul style="list-style-type: none">Description: Bracket with adapter board	Mounting bracket	2050022

SICK AT A GLANCE

SICK is one of the leading manufacturers of intelligent sensors and sensor solutions for industrial applications. A unique range of products and services creates the perfect basis for controlling processes securely and efficiently, protecting individuals from accidents and preventing damage to the environment.

We have extensive experience in a wide range of industries and understand their processes and requirements. With intelligent sensors, we can deliver exactly what our customers need. In application centers in Europe, Asia and North America, system solutions are tested and optimized in accordance with customer specifications. All this makes us a reliable supplier and development partner.

Comprehensive services complete our offering: SICK LifeTime Services provide support throughout the machine life cycle and ensure safety and productivity.

For us, that is “Sensor Intelligence.”

WORLDWIDE PRESENCE:

Contacts and other locations –www.sick.com