



LUT9U-P120L

LUT9

LUMINESCENCE SENSORS

SICK
Sensor Intelligence.



Illustration may differ



Ordering information

Type	part no.
LUT9U-P120L	1046188

Other models and accessories → www.sick.com/LUT9

Detailed technical data

Features

Housing design	Large
Dimensions (W x H x D)	30.4 mm x 53 mm x 80 mm
Light source	LED, Ultraviolet light ¹⁾
Light emission	Long side
Light spot size	3 mm x 9 mm
Light spot direction	Vertical
Receiving filters	≤ 420 nm ²⁾
Wave length	375 nm
Working range	10 mm ... 40 mm
Sensing distance	20 mm ³⁾
Receiving range	450 nm ... 750 nm
Adjustment	Teach-in button, IO-Link (optional)
Output function	Light switching ⁴⁾

¹⁾ Average service life: 100,000 h at T_U = +25 °C.

²⁾ Filter blocks shorter wavelengths to suppress background luminescence.

³⁾ From leading edge of lens.

⁴⁾ L/D switching via teach-in or IO-Link.

Interfaces

IO-Link	✓, IO-Link V1.0
VendorID	26
DeviceID HEX	80000F
DeviceID DEC	8388623
Cycle time	2.3 ms

Process data structure	Bit 0 = switching signal Q _{L1} Bit 1 ... 5 = empty Bit 6 ... 15 = Analog Measurement Value
-------------------------------	--

Electronics

Supply voltage	10 V DC ... 30 V DC ¹⁾
Ripple	< 5 V _{pp} ²⁾
Current consumption	< 100 mA ³⁾
Switching frequency	0.5 kHz ⁴⁾ 2.5 kHz 6.5 kHz Adjustable
Response time	1 ms 200 μs 75 μs
Switching output	PNP
Switching output (voltage)	PNP: HIGH = U _V ≤ 2 V / LOW approx. 0 V
Switching mode	Light switching
Analog output	0 mA ... 13 mA
Output current I_{max.}	100 mA
Time delay	Switch-off delay, 0 ms / 10 ms / 20 ms, adjustable (0 ms = default)
Protection class	II ⁵⁾
Circuit protection	U _V connections, reverse polarity protected Output Q short-circuit protected Interference pulse suppression
Connection type	Male connector M12, 4-pin

¹⁾ Limit values when operated in short-circuit protected network: max. 8 A.

²⁾ May not fall below or exceed U_V tolerances.

³⁾ Without load.

⁴⁾ With light/dark ratio 1:1, without timer stage.

⁵⁾ Reference voltage DC 50 V.

Mechanics

Housing material	Zinc diecast
Weight	400 g

Ambient data

Ambient operating temperature	-10 °C ... +55 °C
Ambient temperature, storage	-25 °C ... +75 °C
Shock load	According to IEC 60068
Enclosure rating	IP67

Certificates

EU declaration of conformity	✓
UK declaration of conformity	✓

ACMA declaration of conformity	✓
Moroccan declaration of conformity	✓
China RoHS	✓
Photobiological safety (IEC EN 62471)	✓
Information according to Art. 3 of Data Act (Regulation EU 2023/2854)	✓

Classifications

ECLASS 5.0	27270908
ECLASS 5.1.4	27270908
ECLASS 6.0	27270908
ECLASS 6.2	27270908
ECLASS 7.0	27270908
ECLASS 8.0	27270908
ECLASS 8.1	27270908
ECLASS 9.0	27270908
ECLASS 10.0	27270908
ECLASS 11.0	27270908
ECLASS 12.0	27270908
ETIM 5.0	EC001822
ETIM 6.0	EC001822
ETIM 7.0	EC001822
ETIM 8.0	EC001822
UNSPSC 16.0901	39121528

Dimensional drawing LUT9x-x1xxx, light Emission: Long side

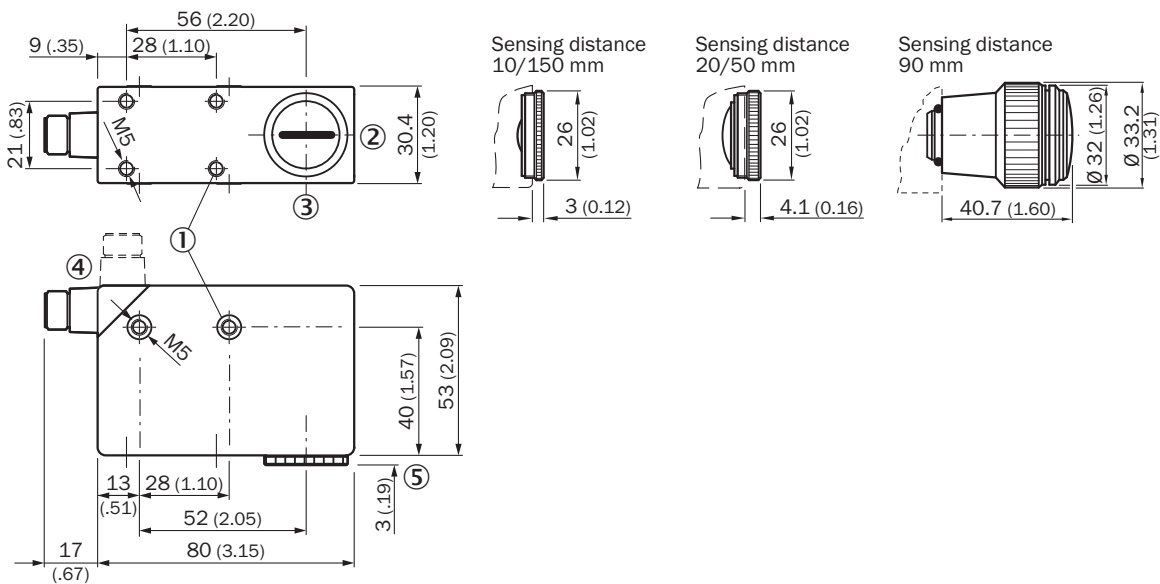

Dimensions in mm (inch)

- ① M5 threaded mounting hole, 5.5 mm deep
- ② Lens (light transmission), can be replaced by blind screw
- ③ Center of optical axis
- ④ Connector M12 (rotatable up to 90°)
- ⑤ see dimensional drawings of lenses
- ⑥ Blind screw can be replaced by lens

Adjustments

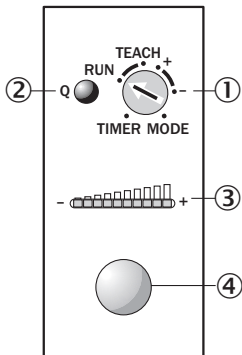

- ① Rotary selection switch
- ② Function signal indicator (yellow), switching output
- ③ bar graph (green), power-on left-hand LED
- ④ Teach-in button

Connection diagram Cd-309

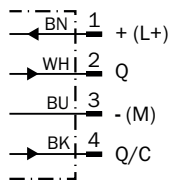

Concept of operation Teach-in static

1. Position mark

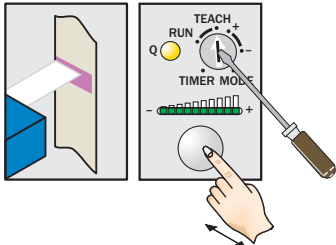

Turn rotary switch to “TEACH” position and press and hold teach-in button > 1 s. Yellow LED flashes slowly.

2. Position background

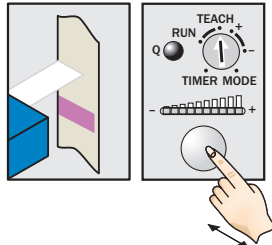

Press and hold teach-in button again > 1 s. Yellow LED goes out.

Sensitivity setting

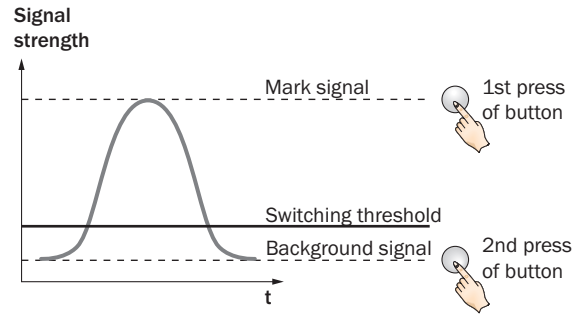

Note

The bar graph display shows detection reliability. The more LEDs that illuminate, the better the teach-in.

Concept of operation Button +/-

1. Position mark

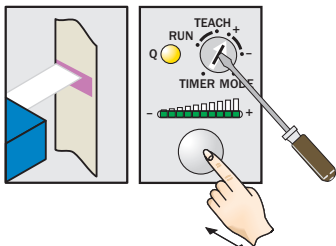

Turn rotary switch to “+” position and press and hold teach-in button until yellow light goes out (more green LEDs illuminate on the bar display).

2. Position background

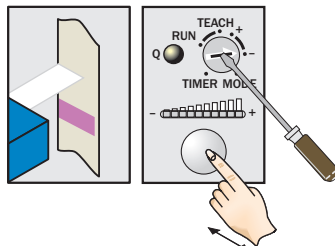

If yellow LED illuminates, turn rotary switch to “-” position and press and hold teach-in button until yellow light just goes out (green LEDs go out on the bar display).

Sensitivity setting

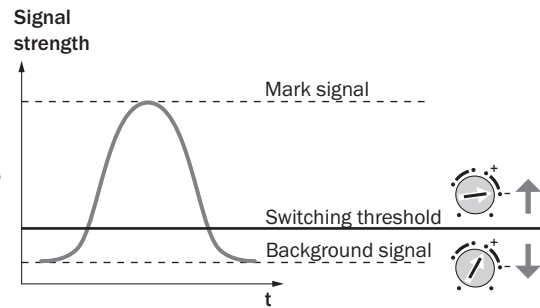

Note for all settings

Once configuration is complete, turn the rotary switch to the “RUN” position. The bar display then shows the luminescence intensity (regardless of switching threshold setting).

Adjustments are intended for luminescence background suppression.

Sensing distance

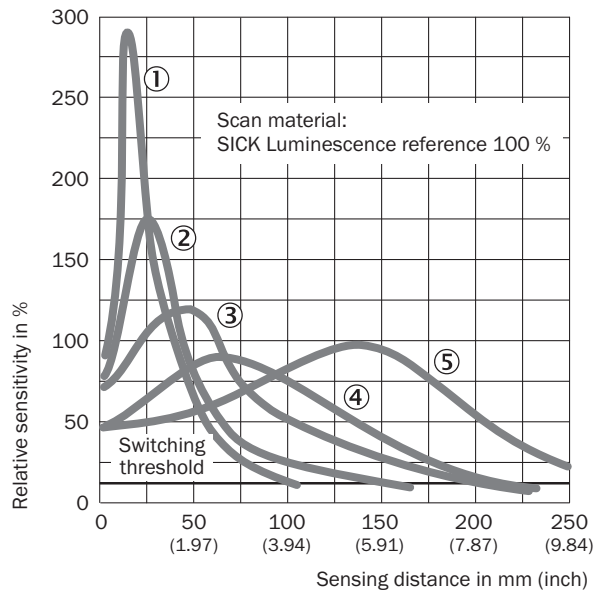

- ① Sensing distance 10 mm
- ② Sensing distance 20 mm
- ③ Sensing distance 50 mm
- ④ Sensing distance 90 mm
- ⑤ Sensing distance 150 mm

Light spot size

Sensing distance 10 mm

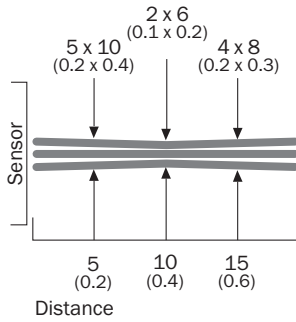

Sensing distance 20 mm

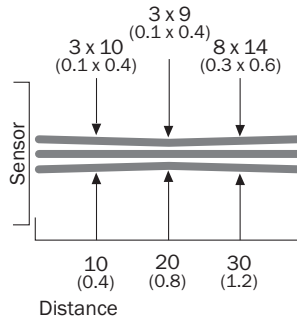

Sensing distance 50 mm

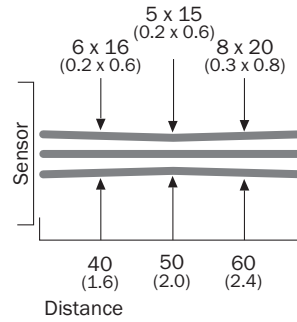

Sensing distance 90 mm

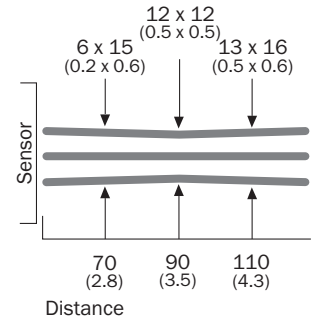

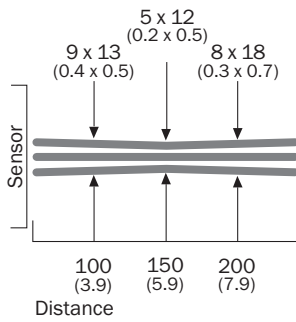

Sensing distance 150 mm



All dimensions in mm (inch)





Recommended accessories

Other models and accessories → www.sick.com/LUT9

	Brief description	Type	part no.
Mounting systems			
	<ul style="list-style-type: none"> Description: Plate G for universal clamp bracket Material: Steel Details: Steel, zinc coated Items supplied: Universal clamp (2022726), mounting hardware Usable for: W34, LUT3, KT5-2, KT10, CS8, W24-2, KT8, KT8 	BEF-KHS-G01	2022464
	<ul style="list-style-type: none"> Description: Plate K for universal clamp bracket Material: Steel Details: Steel, zinc coated Items supplied: Universal clamp (2022726), mounting hardware Usable for: W11-2, W12-3, W14-2, W18-3, W23-2, W24-2, W27-3, W30, W32, W34, W36, PL50A, PL80A, P250, UC12, LUT3, KT2, KT5-2, KT8, CS8, DT2, DS30, DS40, W12-2 Laser, W16, W26, KT5 	BEF-KHS-K01	2022718

	Brief description	Type	part no.
reflectors and optics			
	<ul style="list-style-type: none"> • Description: Lens, 10 mm sensing distance 	OBJ-LUT3-10	2016348
	<ul style="list-style-type: none"> • Description: Lens, 20 mm sensing distance 	OBJ-LUT3-20	2016349
	<ul style="list-style-type: none"> • Description: Lens, 50 mm sensing distance 	OBJ-LUT3-50	2016350
	<ul style="list-style-type: none"> • Description: Lens, 90 mm scanning distance 	OBJ-026	1001326

	Brief description	Type	part no.
connectors and cables			
	<ul style="list-style-type: none"> • Description: Unshielded • Connection type head A: Female connector, M12, 4-pin, straight, A-coded • Connection systems: Screw-type terminals • Permitted cross-section: ≤ 0.75 mm² 	DOS-1204-G	6007302
	<ul style="list-style-type: none"> • Description: Unshielded • Connection type head A: Female connector, M12, 4-pin, angled, A-coded • Connection systems: Screw-type terminals • Permitted cross-section: ≤ 0.75 mm² 	DOS-1204-W	6007303
	<ul style="list-style-type: none"> • Description: Sensor/actuator cable, unshielded • Connection type head A: Female connector, M12, 4-pin, straight, A-coded • Connection type head B: Flying leads • Signal type: Sensor/actuator cable • Cable: 2 m, 4-wire, PVC • Application: Uncontaminated zones, Zones with chemicals 	YF2A14-020VB3XLEAX	2096234
	<ul style="list-style-type: none"> • Description: Sensor/actuator cable, unshielded • Connection type head A: Female connector, M12, 4-pin, straight, A-coded • Connection type head B: Flying leads • Signal type: Sensor/actuator cable • Cable: 5 m, 4-wire, PVC • Application: Uncontaminated zones, Zones with chemicals 	YF2A14-050VB3XLEAX	2096235
	<ul style="list-style-type: none"> • Description: Sensor/actuator cable, unshielded • Connection type head A: Female connector, M12, 4-pin, straight, A-coded • Connection type head B: Flying leads • Signal type: Sensor/actuator cable • Cable: 10 m, 4-wire, PVC • Application: Uncontaminated zones, Zones with chemicals 	YF2A14-100VB3XLEAX	2096236
	<ul style="list-style-type: none"> • Description: Sensor/actuator cable, unshielded • Connection type head A: Female connector, M12, 4-pin, straight, A-coded • Connection type head B: Flying leads • Signal type: Sensor/actuator cable • Cable: 15 m, 4-wire, PVC • Application: Uncontaminated zones, Zones with chemicals 	YF2A14-150VB3XLEAX	2096237
	<ul style="list-style-type: none"> • Description: Sensor/actuator cable, unshielded • Connection type head A: Female connector, M12, 4-pin, angled, A-coded • Connection type head B: Flying leads • Signal type: Sensor/actuator cable • Cable: 2 m, 4-wire, PVC • Application: Uncontaminated zones, Zones with chemicals 	YG2A14-020VB3XLEAX	2095895
	<ul style="list-style-type: none"> • Description: Sensor/actuator cable, unshielded • Connection type head A: Female connector, M12, 4-pin, angled, A-coded • Connection type head B: Flying leads • Signal type: Sensor/actuator cable • Cable: 5 m, 4-wire, PVC • Application: Uncontaminated zones, Zones with chemicals 	YG2A14-050VB3XLEAX	2095897
	<ul style="list-style-type: none"> • Description: Sensor/actuator cable, unshielded • Connection type head A: Female connector, M12, 4-pin, angled, A-coded • Connection type head B: Flying leads • Signal type: Sensor/actuator cable • Cable: 10 m, 4-wire, PVC • Application: Uncontaminated zones, Zones with chemicals 	YG2A14-100VB3XLEAX	2095898
	<ul style="list-style-type: none"> • Description: Sensor/actuator cable, unshielded • Connection type head A: Female connector, M12, 4-pin, angled, A-coded • Connection type head B: Flying leads • Signal type: Sensor/actuator cable • Cable: 0.6 m, 4-wire, PVC • Application: Uncontaminated zones, Zones with chemicals 	YG2A14-C60VB3XLEAX	2145709
	<ul style="list-style-type: none"> • Description: Sensor/actuator cable, unshielded • Connection type head A: Female connector, M12, 4-pin, angled, A-coded • Connection type head B: Flying leads • Signal type: Sensor/actuator cable • Cable: 1 m, 4-wire, PVC 	YG2A14-010VB3XLEAX	2145710

	Brief description	Type	part no.
	<ul style="list-style-type: none"> • Application: Uncontaminated zones, Zones with chemicals • Description: Sensor/actuator cable, unshielded • Connection type head A: Female connector, M12, 4-pin, straight, A-coded • Connection type head B: Flying leads • Signal type: Sensor/actuator cable • Cable: 0.6 m, 4-wire, PVC • Application: Uncontaminated zones, Zones with chemicals 	YF2A14-C60VB3XLEAX	2145707
	<ul style="list-style-type: none"> • Description: Sensor/actuator cable, unshielded • Connection type head A: Female connector, M12, 4-pin, straight, A-coded • Connection type head B: Flying leads • Signal type: Sensor/actuator cable • Cable: 1 m, 4-wire, PVC • Application: Uncontaminated zones, Zones with chemicals 	YF2A14-010VB3XLEAX	2145708
network devices			
		SIG200-0A0412200	1089794
		SIG200-0A0G12200	1102605

SICK AT A GLANCE

SICK is one of the leading manufacturers of intelligent sensors and sensor solutions for industrial applications. A unique range of products and services creates the perfect basis for controlling processes securely and efficiently, protecting individuals from accidents and preventing damage to the environment.

We have extensive experience in a wide range of industries and understand their processes and requirements. With intelligent sensors, we can deliver exactly what our customers need. In application centers in Europe, Asia and North America, system solutions are tested and optimized in accordance with customer specifications. All this makes us a reliable supplier and development partner.

Comprehensive services complete our offering: SICK LifeTime Services provide support throughout the machine life cycle and ensure safety and productivity.

For us, that is “Sensor Intelligence.”

WORLDWIDE PRESENCE:

Contacts and other locations –www.sick.com