



# MPS-096TSTP0

MPS-T

CYLINDER SENSORS

**SICK**  
Sensor Intelligence.



### Ordering information

Type	part no.
MPS-096TSTP0	1045670

Other models and accessories → [www.sick.com/MPS-T](http://www.sick.com/MPS-T)



### Detailed technical data

#### Features

<b>Cylinder type</b>	T-slot
<b>Cylinder types with adapter</b>	Round body cylinder Profile cylinders and tie-rod cylinders Dovetail groove cylinder
<b>Measuring range</b>	96 mm <sup>1)</sup>
<b>Housing length</b>	109 mm
<b>Output function</b>	Analog
<b>Electrical wiring</b>	DC 4-wire
<b>Analog output (voltage)</b>	0 V ... 10 V <sup>2)</sup>
<b>Analog output (current)</b>	4 mA ... 20 mA <sup>2)</sup>
<b>Enclosure rating</b>	IP67 <sup>3)</sup>
<b>Adjustment</b>	
Teach-in control panel	Teaching in analog outputs Resetting the measuring range to factory settings

<sup>1)</sup> ± 1 mm.

<sup>2)</sup> The sensor only activates the wired output.

<sup>3)</sup> According to EN 60529.

#### Mechanics/electronics

<b>Supply voltage</b>	15 V DC ... 30 V DC
<b>Power consumption</b>	22 mA, without load
<b>Max. load resistance</b>	≤ 500 Ω Power Output, at 24 V
<b>Min. load resistance</b>	≥ 2 kΩ <sup>1)</sup>

<sup>1)</sup> Voltage output.

<sup>2)</sup> FSR: Full Scale Range; max. measuring range.

<sup>3)</sup> At 25 ° C, linearity error (maximum deviation) depending on response curve and minimal deviation function.

<sup>4)</sup> At 25 ° C, repeatability magnet movement in one direction.

<sup>5)</sup> Only in standard mode, not in IO-Link mode.

<sup>6)</sup> The analog measured value can deviate for up to 100 ms under transient conditions.

<b>Protection class</b>	III
<b>Time delay before availability</b>	1.5 s
<b>Required magnetic field sensitivity, typ.</b>	4 mT ... 30 mT
<b>Resolution, typ.</b>	0.03 % FSR (max. $\geq 0.05$ mm) <sup>2)</sup>
<b>Linearity error, typ.</b>	0.3 mm <sup>3)</sup>
<b>Repeat accuracy, typ.</b>	0.06 % FSR ( $\geq 0.1$ mm) <sup>4)</sup>
<b>Sampling rate, typ.</b>	1 ms <sup>5)</sup>
<b>Reverse polarity protection</b>	Yes
<b>Short-circuit protection</b>	Yes
<b>Status indicator LED</b>	Yes
<b>Teach-in</b>	Yes
<b>Ambient operating temperature</b>	-20 °C ... +70 °C
<b>Shock and vibration resistance</b>	30 g, 11 ms / 10 ... 55 Hz, 1 mm
<b>EMC</b>	According to EN 60947-5-7 <sup>6)</sup>
<b>Connection type</b>	Cable with M8 male connector, 4-pin, 0.3 m
<b>Connection type Detail</b>	
Deep-freeze property	Do not bend below 0 °C
Conductor cross section	0.08 mm <sup>2</sup>
Cable diameter	Ø 2.6 mm
Bending radius	With fixed installation > 5 x cable diameter For flexible use > 10 x cable diameter
Cable outlet	Axial
<b>Material</b>	
Housing	Plastic
Cable	PUR
<b>UL File No.</b>	NRKH.E181493 & NRKH7.E181493

1) Voltage output.

2) FSR: Full Scale Range; max. measuring range.

3) At 25 °C, linearity error (maximum deviation) depending on response curve and minimal deviation function.

4) At 25 °C, repeatability magnet movement in one direction.

5) Only in standard mode, not in IO-Link mode.

6) The analog measured value can deviate for up to 100 ms under transient conditions.

### Safety-related parameters

<b>MTTF<sub>D</sub></b>	296 years
<b>DC<sub>avg</sub></b>	0 %
<b>T<sub>M</sub> (mission time)</b>	20 years

### Certificates

<b>EU declaration of conformity</b>	✓
<b>UK declaration of conformity</b>	✓
<b>ACMA declaration of conformity</b>	✓
<b>Moroccan declaration of conformity</b>	✓
<b>China RoHS</b>	✓

<b>cULus certificate</b>	✓
--------------------------	---

### Classifications

<b>ECLASS 5.0</b>	27270104
<b>ECLASS 5.1.4</b>	27270104
<b>ECLASS 6.0</b>	27270104
<b>ECLASS 6.2</b>	27270104
<b>ECLASS 7.0</b>	27270104
<b>ECLASS 8.0</b>	27270104
<b>ECLASS 8.1</b>	27270104
<b>ECLASS 9.0</b>	27270104
<b>ECLASS 10.0</b>	27270104
<b>ECLASS 11.0</b>	27270104
<b>ECLASS 12.0</b>	27274301
<b>ETIM 5.0</b>	EC002544
<b>ETIM 6.0</b>	EC002544
<b>ETIM 7.0</b>	EC002544
<b>ETIM 8.0</b>	EC002544
<b>UNSPSC 16.0901</b>	39122230

### Installation note

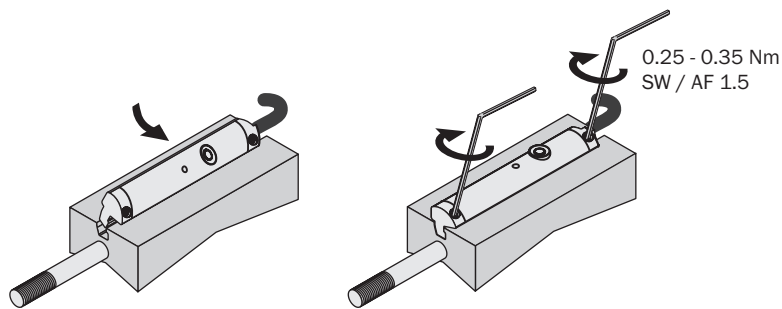

### Connection diagram Cd-034

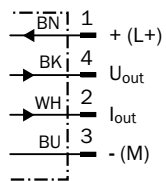

Dimensional drawing Cable with connector M8, Teach-in

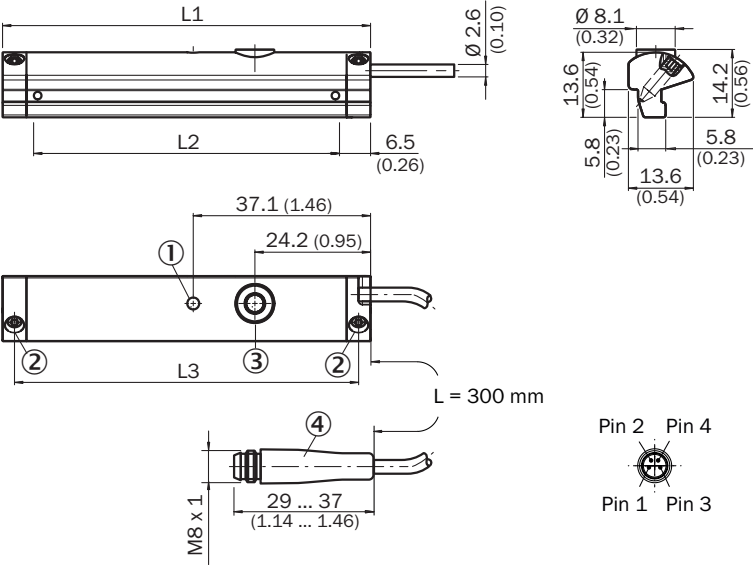





	Total length (L1) mm	Measuring range (L2) mm	Distance mounting screws (L3) mm
<b>MPS-32</b>	45	32	40
<b>MPS-64</b>	77	64	72
<b>MPS-96</b>	109	96	104
<b>MPS-128</b>	141	128	136
<b>MPS-160</b>	173	160	168
<b>MPS-192</b>	205	192	200
<b>MPS-224</b>	237	224	232
<b>MPS-256</b>	269	256	264





- Dimensions in mm (inch)
- ① function indicator
  - ② Fixing screw SW 1.5
  - ③ Teach-in button
  - ④ Connection

Recommended accessories

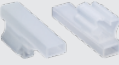
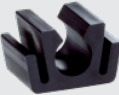
Other models and accessories → [www.sick.com/MPS-T](http://www.sick.com/MPS-T)

	Brief description	Type	part no.
Mounting systems			
	<ul style="list-style-type: none"> <li>• <b>Description:</b> Mounting bracket for mounting on SMC rails ECDQ2 (T-slot)</li> <li>• <b>Material:</b> Aluminum</li> <li>• <b>Details:</b> Aluminum</li> <li>• <b>Items supplied:</b> Without mounting hardware</li> </ul>	BEF-KHZ-TT1	2046439
	<ul style="list-style-type: none"> <li>• <b>Description:</b> Mounting bracket for mounting on SMC rails CDQ2 (T-slot)</li> <li>• <b>Material:</b> Aluminum</li> <li>• <b>Details:</b> Aluminum</li> <li>• <b>Items supplied:</b> Without mounting hardware</li> </ul>	BEF-KHZ-TT2	2046440
	<ul style="list-style-type: none"> <li>• <b>Description:</b> Mounting bracket for cylinder with dovetail slot</li> <li>• <b>Material:</b> Aluminum</li> <li>• <b>Details:</b> Aluminum</li> <li>• <b>Items supplied:</b> Without mounting hardware</li> </ul>	BEF-KHZ-ST1	2022703
	<ul style="list-style-type: none"> <li>• <b>Description:</b> Mounting bracket on round body cylinder with piston diameter of 16 mm, ambient temperature min 0 °C max 50 °C</li> <li>• <b>Dimensions (W x H x L):</b> 26.6 m</li> <li>• <b>Material:</b> Plastic, Aluminum</li> <li>• <b>Details:</b> Plastic, Aluminum</li> <li>• <b>Packing unit:</b> 1 piece</li> <li>• <b>Suitable for:</b> T-slot</li> </ul>	BEF-KHZ-RT-16	2077680
	<ul style="list-style-type: none"> <li>• <b>Description:</b> Mounting bracket on round body cylinder with piston diameter of 8 mm ... 130 mm, ambient temperature min -30 °C max 80 °C</li> <li>• <b>Material:</b> Stainless steel, Zinc cast</li> <li>• <b>Details:</b> Stainless steel, Zinc cast</li> <li>• <b>Packing unit:</b> 1 piece</li> <li>• <b>Suitable for:</b> T-slot</li> </ul>	BEF-KHZ-RT1-130	2077684
	<ul style="list-style-type: none"> <li>• <b>Description:</b> Mounting bracket on round body cylinder with piston diameter of 12 mm, ambient temperature min 0 °C max 50 °C</li> <li>• <b>Dimensions (W x H x L):</b> 22.4 m</li> <li>• <b>Material:</b> Plastic, Aluminum</li> <li>• <b>Details:</b> Plastic, Aluminum</li> <li>• <b>Packing unit:</b> 1 piece</li> <li>• <b>Suitable for:</b> T-slot</li> </ul>	BEF-KHZ-RT-12	2077681
	<ul style="list-style-type: none"> <li>• <b>Description:</b> Mounting bracket on round body cylinder with piston diameter of 8 mm ... 25 mm, ambient temperature min -30 °C max 80 °C</li> <li>• <b>Material:</b> Stainless steel, Zinc cast</li> <li>• <b>Details:</b> Stainless steel, Zinc cast</li> <li>• <b>Packing unit:</b> 1 piece</li> <li>• <b>Suitable for:</b> T-slot</li> </ul>	BEF-KHZ-RT1-25	2077682
	<ul style="list-style-type: none"> <li>• <b>Description:</b> Mounting bracket on round body cylinder with piston diameter of 8 mm ... 63 mm, ambient temperature min -30 °C max 80 °C</li> <li>• <b>Material:</b> Stainless steel, Zinc cast</li> <li>• <b>Details:</b> Stainless steel, Zinc cast</li> <li>• <b>Packing unit:</b> 1 piece</li> <li>• <b>Suitable for:</b> T-slot</li> </ul>	BEF-KHZ-RT1-63	2077683
	<ul style="list-style-type: none"> <li>• <b>Description:</b> Mounting bracket on round body cylinder with piston diameter of 20 mm, ambient temperature min 0 °C max 50 °C</li> <li>• <b>Dimensions (W x H x L):</b> 30.6 m</li> <li>• <b>Material:</b> Plastic, Aluminum</li> <li>• <b>Details:</b> Plastic, Aluminum</li> <li>• <b>Packing unit:</b> 1 piece</li> <li>• <b>Suitable for:</b> T-slot</li> </ul>	BEF-KHZ-RT-20	2077679
	<ul style="list-style-type: none"> <li>• <b>Description:</b> Mounting bracket on round body cylinder with piston diameter of 25 mm, ambient temperature min 0 °C max 50 °C</li> <li>• <b>Dimensions (W x H x L):</b> 35.7 m</li> <li>• <b>Material:</b> Plastic, Aluminum</li> <li>• <b>Details:</b> Plastic, Aluminum</li> <li>• <b>Packing unit:</b> 1 piece</li> </ul>	BEF-KHZ-RT-25	2077678

	Brief description	Type	part no.
	<ul style="list-style-type: none"> <li>• <b>Suitable for:</b> T-slot</li> <li>• <b>Description:</b> Mounting bracket on round body cylinder with piston diameter of 32 mm, ambient temperature min 0 °C max 50 °C</li> <li>• <b>Dimensions (W x H x L):</b> 42.9 mm</li> <li>• <b>Material:</b> Plastic, Aluminum</li> <li>• <b>Details:</b> Plastic, Aluminum</li> <li>• <b>Packing unit:</b> 1 piece</li> <li>• <b>Suitable for:</b> T-slot</li> </ul>	BEF-KHZ-RT-32	2077677
	<ul style="list-style-type: none"> <li>• <b>Description:</b> Mounting bracket on round body cylinder with piston diameter of 40 mm, ambient temperature min 0 °C max 50 °C</li> <li>• <b>Dimensions (W x H x L):</b> 50.9 mm</li> <li>• <b>Material:</b> Plastic, Aluminum</li> <li>• <b>Details:</b> Plastic, Aluminum</li> <li>• <b>Packing unit:</b> 1 piece</li> <li>• <b>Suitable for:</b> T-slot</li> </ul>	BEF-KHZ-RT-40	2077676
	<ul style="list-style-type: none"> <li>• <b>Description:</b> Mounting bracket on round body cylinder with piston diameter of 50 mm, ambient temperature min 0 °C max 50 °C</li> <li>• <b>Dimensions (W x H x L):</b> 61.8 mm</li> <li>• <b>Material:</b> Plastic, Aluminum</li> <li>• <b>Details:</b> Plastic, Aluminum</li> <li>• <b>Packing unit:</b> 1 piece</li> <li>• <b>Suitable for:</b> T-slot</li> </ul>	BEF-KHZ-RT-50	2077675
	<ul style="list-style-type: none"> <li>• <b>Description:</b> Mounting bracket on round body cylinder with piston diameter of 63 mm, ambient temperature min 0 °C max 50 °C</li> <li>• <b>Dimensions (W x H x L):</b> 73.9 mm</li> <li>• <b>Material:</b> Plastic, Aluminum</li> <li>• <b>Details:</b> Plastic, Aluminum</li> <li>• <b>Packing unit:</b> 1 piece</li> <li>• <b>Suitable for:</b> T-slot</li> </ul>	BEF-KHZ-RT-63	2077674
	<ul style="list-style-type: none"> <li>• <b>Description:</b> Mounting bracket for integrated profile cylinder/tie-rod cylinder</li> <li>• <b>Material:</b> Zinc diecast</li> <li>• <b>Details:</b> Zinc diecast</li> <li>• <b>Items supplied:</b> Mounting hardware included</li> </ul>	BEF-KHZ-PT1	2022702
	<ul style="list-style-type: none"> <li>• <b>Description:</b> Label Holder, 2.5 mm to 3.5 mm, 10 pcs.</li> <li>• <b>Material:</b> Plastic</li> <li>• <b>Details:</b> TPU</li> <li>• <b>Packing unit:</b> 10 pieces</li> </ul>	LABEL HOLDER	2086019
	<ul style="list-style-type: none"> <li>• <b>Description:</b> Cable clips T-slot, 10 pcs./bag</li> </ul>	CABLE CLIPS	2059322

	Brief description	Type	part no.
connectors and cables			
	<ul style="list-style-type: none"> <li><b>Description:</b> Unshielded</li> <li><b>Connection type head A:</b> Female connector, M8, 4-pin, straight, A-coded</li> <li><b>Connection systems:</b> Screw-type terminals</li> <li><b>Permitted cross-section:</b> 0.14 mm<sup>2</sup> ... 0.5 mm<sup>2</sup></li> </ul>	DOS-0804-G	6009974
	<ul style="list-style-type: none"> <li><b>Description:</b> Unshielded</li> <li><b>Connection type head A:</b> Male connector, M8, 4-pin, straight, A-coded</li> <li><b>Connection systems:</b> Screw-type terminals</li> <li><b>Permitted cross-section:</b> 0.14 mm<sup>2</sup> ... 0.5 mm<sup>2</sup></li> </ul>	STE-0804-G	6037323
	<ul style="list-style-type: none"> <li><b>Description:</b> Unshielded</li> <li><b>Connection type head A:</b> Female connector, M8, 4-pin, angled, A-coded</li> <li><b>Connection systems:</b> Solder connection</li> <li><b>Permitted cross-section:</b> ≤ 0.25 mm<sup>2</sup></li> </ul>	DOS-0804-W	6009975
	<ul style="list-style-type: none"> <li><b>Description:</b> Sensor/actuator cable, unshielded</li> <li><b>Connection type head A:</b> Female connector, M8, 4-pin, straight, A-coded</li> <li><b>Connection type head B:</b> Flying leads</li> <li><b>Signal type:</b> Sensor/actuator cable</li> <li><b>Cable:</b> 0.6 m, 4-wire, PUR, halogen-free</li> <li><b>Application:</b> Drag chain operation, Zones with oils and lubricants, Robot, Drag chain operation</li> </ul>	YF8U14-C60UA3XLEAX	2145825
	<ul style="list-style-type: none"> <li><b>Description:</b> Sensor/actuator cable, unshielded</li> <li><b>Connection type head A:</b> Female connector, M8, 4-pin, straight, A-coded</li> <li><b>Connection type head B:</b> Flying leads</li> <li><b>Signal type:</b> Sensor/actuator cable</li> <li><b>Cable:</b> 1 m, 4-wire, PUR, halogen-free</li> <li><b>Application:</b> Drag chain operation, Zones with oils and lubricants, Robot, Drag chain operation</li> </ul>	YF8U14-010UA3XLEAX	2145826

## SICK AT A GLANCE

SICK is one of the leading manufacturers of intelligent sensors and sensor solutions for industrial applications. A unique range of products and services creates the perfect basis for controlling processes securely and efficiently, protecting individuals from accidents and preventing damage to the environment.

We have extensive experience in a wide range of industries and understand their processes and requirements. With intelligent sensors, we can deliver exactly what our customers need. In application centers in Europe, Asia and North America, system solutions are tested and optimized in accordance with customer specifications. All this makes us a reliable supplier and development partner.

Comprehensive services complete our offering: SICK LifeTime Services provide support throughout the machine life cycle and ensure safety and productivity.

For us, that is “Sensor Intelligence.”

## WORLDWIDE PRESENCE:

Contacts and other locations –[www.sick.com](http://www.sick.com)