



FX3-CPU130002

Flexi Soft

SAFETY CONTROLLERS

SICK
Sensor Intelligence.



Ordering information

Type	part no.
FX3-CPU130002	1043784

Other models and accessories → www.sick.com/Flexi_Soft



Detailed technical data

Features

Module	Main module
Configuration method	Via software (Flexi Soft Designer)
Note	The system plug has to be ordered separately. For details, see "Accessories".
Items supplied	Main module without system plug Terminal plug spring for EFI interface Safety instruction Operating instructions for download

Safety-related parameters

Safety integrity level	SIL 3 (IEC 61508)
Category	Category 4 (EN ISO 13849)
Performance level	PL e (EN ISO 13849)
PFH_D (mean probability of a dangerous failure per hour)	1.69×10^{-9} (EN ISO 13849)
T_M (mission time)	20 years (EN ISO 13849)

Functions

Safe SICK device communication	✓
Safe networking	
Flexi Link	✓

Interfaces

System connection	System plug ¹⁾
Number of EFI interfaces	2

¹⁾ The system plug has to be ordered separately. For details, see "Accessories".

Connection type	Plug-in spring terminals
Configuration and diagnostics interface	RS-232 (M8 female connector, 4-pin)

¹⁾ The system plug has to be ordered separately. For details, see "Accessories".

Electronics

Protection class	III (EN 61140)
Type of voltage supply	PELV or SELV ¹⁾
Supply voltage V_S	24 V DC (16.8 V DC ... 30 V DC)
Internal power consumption	≤ 2.5 W
Overvoltage category	II (EN 61131-2)
Switch-on time	≤ 18 s

¹⁾ The current of the power supply that powers the main unit must be limited to a maximum of 4 A, either through the power supply itself or a fuse.

Mechanics

Dimensions (W x H x D)	22.5 mm x 96.5 mm x 120.6 mm
Weight	119 g (± 5 %)

Ambient data

Enclosure rating	IP20 (EN 60529)
Ambient operating temperature	-25 °C ... +55 °C
Storage temperature	-25 °C ... +70 °C
Air humidity	≤ 95 %, Non-condensing

Certificates

EU declaration of conformity	✓
UK declaration of conformity	✓
ACMA declaration of conformity	✓
China RoHS	✓
CCC certificate	✓
UK-Type-Examination approval	✓
cULus certificate	✓
KC Mark certificate	✓
cTUVus certificate	✓
S Mark certificate	✓
EC-Type-Examination approval	✓
Information according to Art. 3 of Data Act (Regulation EU 2023/2854)	✓

Classifications

ECLASS 5.0	27243001
ECLASS 5.1.4	27243101
ECLASS 6.0	27243101
ECLASS 6.2	27243101
ECLASS 7.0	27243101

ECLASS 8.0	27243101
ECLASS 8.1	27243101
ECLASS 9.0	27243101
ECLASS 10.0	27243101
ECLASS 11.0	27243101
ECLASS 12.0	27243101
ETIM 5.0	EC001449
ETIM 6.0	EC001449
ETIM 7.0	EC001449
ETIM 8.0	EC001449
UNSPSC 16.0901	32151705

Dimensional drawing FX3-CPU1, FX3-CPU2

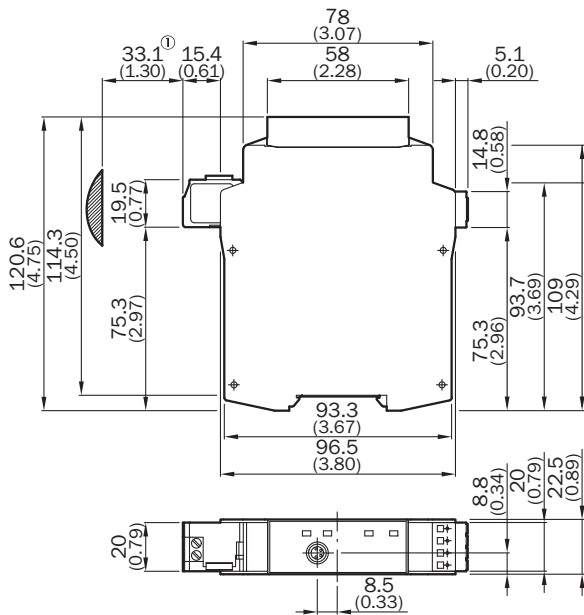



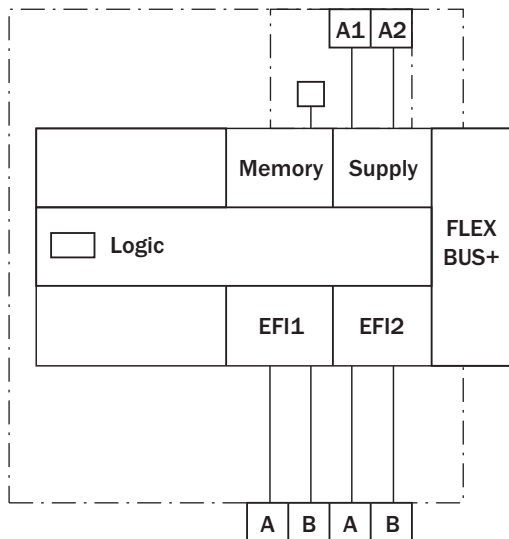

Connection diagram



Recommended accessories

Other models and accessories → www.sick.com/Flexi_Soft

	Brief description	Type	part no.
system plugs and extension modules			
	<ul style="list-style-type: none"> • Connection systems: Screw-type terminals • Compatible devices: For FX3-CPU0 and FX3-CPU1 	FX3-MPL000001	1043700
Safety relays			
	<ul style="list-style-type: none"> • Applications: Output expansion module for OSSDs • Compatible sensor types: Safety sensors with OSSDs • Connection type: Front connector with spring terminals • Restart interlock: no • External device monitoring (EDM): Via path • Outputs: 4 enabling current paths (safe), 1 feedback current path (for use as external device monitoring, not safe), 1 signaling current path (not safe) • Housing width: 28 mm 	RLY3-OSSD400	1099971
	<ul style="list-style-type: none"> • Applications: Output expansion module for OSSDs • Compatible sensor types: Safety sensors with OSSDs • Connection type: Front connector with spring terminals • Restart interlock: no • External device monitoring (EDM): Via path • Outputs: 2 enabling current paths (safe), 1 feedback current path (for use as external device monitoring, not safe) • Housing width: 18 mm 	RLY3-OSSD100	1085343

	Brief description	Type	part no.
connectors and cables			
	<ul style="list-style-type: none"> Description: Unshielded Connection type head A: Male connector, M8, 4-pin, straight Connection type head B: Male connector, USB-A, straight Cable: 2 m, 4-wire, PVC 	DSL-8U04G02M025KM:	6034574
	<ul style="list-style-type: none"> Description: Unshielded Connection type head A: Male connector, M8, 4-pin, straight Connection type head B: Male connector, USB-A, straight Cable: 10 m, 4-wire, PVC 	DSL-8U04G10M025KM:	6034575

SICK AT A GLANCE

SICK is one of the leading manufacturers of intelligent sensors and sensor solutions for industrial applications. A unique range of products and services creates the perfect basis for controlling processes securely and efficiently, protecting individuals from accidents and preventing damage to the environment.

We have extensive experience in a wide range of industries and understand their processes and requirements. With intelligent sensors, we can deliver exactly what our customers need. In application centers in Europe, Asia and North America, system solutions are tested and optimized in accordance with customer specifications. All this makes us a reliable supplier and development partner.

Comprehensive services complete our offering: SICK LifeTime Services provide support throughout the machine life cycle and ensure safety and productivity.

For us, that is “Sensor Intelligence.”

WORLDWIDE PRESENCE:

Contacts and other locations –www.sick.com